

User's and Programmer's Reference

Agilent Technologies PSA Spectrum Analyzers

This manual provides documentation for the following instruments:

E4440A (3 Hz – 26.5 GHz)

E4443A (3 Hz – 6.7 GHz)

E4445A (3 Hz – 13.2 GHz)

E4446A (3 Hz – 44.0 GHz)

E4448A (3 Hz – 50.0 GHz)



Manufacturing Part Number: E4440-90189
Supersedes: E4440-90061

Printed in USA
December 2002

© Copyright 2001 Agilent Technologies

Legal Information

The information contained in this document is subject to change without notice.

Agilent Technologies makes no warranty of any kind with regard to this material, including but not limited to, the implied warranties of merchantability and fitness for a particular purpose. Agilent Technologies shall not be liable for errors contained herein or for incidental or consequential damages in connection with the furnishing, performance, or use of this material.

Where to Find the Latest Information

Documentation is updated periodically. For the latest information about Agilent PSA spectrum analyzers, including firmware upgrades and application information, see: <http://www.agilent.com/find/psa>.

1. Using This Document

Book Organization	44
What is in This Book.....	44
Terms Used in This Book	45

2. Instrument Functions: A – L

AMPLITUDE / Y Scale.....	49
Ref Level	49
Attenuation	50
Scale/Div	52
Scale Type	52
Presel Center	54
Presel Adjust	55
Y Axis Units	56
Ref Lvl Offset	58
Int Preamp	59
Corrections	59
Ext Amp Gain	68
Atten Step	68
Max Mixer Lvl	69
Auto Couple	71
Auto All	71
FFT & Sweep	72
PhNoise Opt	76
Detector	77
Avg/VBW Type	78
ADC Dither	79
ADC Ranging	80
BW/Avg	83
Res BW	83
Video BW	84
VBW/RBW	86
Average	87
Avg/VBW Type	89
Span/RBW	93
Det/Demod	95
Detector	95
Display	103
Full Screen.....	103
Display Line	103
Display Line	104
Active Fctn Position	106
Limits.....	108
Title	122
Preferences	123
Display Enable (Remote Command Only)	125
File	127
Catalog	130
Save	136

Contents

Load	143
Delete	147
Copy	151
Rename	153
Create Dir	155
Delete All	157
Query Trace Data (Remote Command Only)	158
Move Data to a File (Remote Command Only)	158
Set Data Byte Order (Remote Command Only)	160
Format Numeric Data (Remote Command Only)	160
FREQUENCY / Channel	163
Center Freq	163
Start Freq	164
Stop Freq	165
CF Step	166
Freq Offset	167
Signal Track	168
Input/Output	171
Input Port	171
RF Coupling	172
Input Z Corr	172
Trig Input	173
3. Instrument Functions: M – O	
Marker	177
Select Marker	180
Normal	180
Delta	181
Delta Pair	181
Span Pair	184
Off	185
Marker Trace	185
Readout	186
Marker Table	189
Marker All Off	189
Marker Fctn	191
Select Marker	191
Marker Noise	191
Band/Intvl Power	193
Function Off	194
Marker Count	194
Marker ->	197
Mkr->CF	197
Mkr->CF Step	197
Mkr->Start	197
Mkr->Stop	199
MkrΔ->Span	199
MkrΔ->CF	199
Mkr->Ref Lvl	200

Meas Setup (SA with Measurements Off)	201
Measurement Setup	201
MODE	203
Spectrum Analysis	204
Application Mode Number Selection (Remote command only)	204
Application Mode Catalog Query (Remote command only)	206

4. Instrument Functions: P – Z

Peak Search	209
Next Peak	209
Next Pk Right	210
Next Pk Left	210
Min Search	211
Pk-Pk Search	212
Mkr->CF	212
Continuous Pk	212
N dB Points	213
Search Param	215
Preset	221
User Preset	222
Mode Preset	224
Factory Preset	224
Save User Preset	225
Print	227
Abort the Printout (Remote Command Only)	227
Print Setup	229
Printer Setup	229
Orientation	231
Prints/Page	232
Eject Page	232
Page Size	232
Color	234
Save	235
SPAN / X Scale	237
Span	237
Span Zoom	238
Full Span	238
Zero Span	238
Last Span	239
SWEEP	241
Sweep Time	241
Sweep	242
Auto Sweep Time	243
Points	244
System	247
Show Errors	247
Power On/Preset	248
Time/Date	252
Alignments	255

Contents

Config I/O	262
Reference	268
Show System	270
Show Hdwr	271
Color Palette	271
Diagnostics	274
Restore Sys Defaults	274
Licensing	276
Personality	279
Service	279
Keyboard Lock (Remote Command Only)	280
Remote Message	280
Remote Message Turned Off	281
Power On Elapsed Time (Remote Command Only)	281
SCPI Version Query (Remote Command Only)	281
Trace/View	283
Query Trace Data (Remote Command Only)	284
Trace	284
Clear Write	285
Max Hold	285
Min Hold	285
View	286
Blank	286
Trig	287
Free Run	287
Video	288
Line	288
Ext Front	289
Ext Rear	289
RF Burst (Wideband)	289
Trig Slope	290
Trig Delay	290
Trig Offset (Remote Command Only)	291
5. One-Button Measurement Functions	
One - Button Measurement Functions	294
MEASURE (Spectrum Analysis Mode)	297
Command Interactions: MEASure, CONFigure, FETCh, INITiate and READ	297
Meas Off	300
Channel Power	301
Occupied BW	304
Adjacent Channel Power—ACP	305
Multi-Carrier Power	309
Power Stat CCDF	312
Harmonic Distortion	315
Burst Power	318
Intermod (TOI)	321
Spurious Emissions	322
Spectrum Emission Mask	322

Current Measurement Query (Remote Command Only)	328
Meas Control	329
Restart	329
Measure	329
Pause or Resume	330
Trigger a Sweep or Measurement (Remote Command Only)	330
Abort the Sweep or Measurement (Remote Command Only)	331
Mode Setup (Spectrum Analysis Mode)	333
Radio Std	333
Radio Std Setup	341
Retain Params	342
Enable All Measurements	344
Autorange of Power Setting (Remote command only)	344
Restart	347
Single	349
Meas Setup (Adjacent Channel Power—ACP)	351
Avg Number	351
Avg Mode	353
Chan Integ BW	353
Offset/Limits	354
Meas Type	359
Optimize Ref Level	360
Method	360
Total Pwr Ref	362
PSD Ref	362
Limit Test	363
RRC Filter	363
Filter Alpha	364
Noise Correction	364
Trace/View (ACP Measurement)	367
Spectrum	367
Bar Graph	367
Combined	368
Combined View Units	368
Trace	368
Meas Setup (Burst Power)	371
Avg Number	371
Avg Mode	372
Average Type	372
Threshold Lvl	373
Meas Method	373
Burst Width	374
Optimize Ref Level	375
Trace/View (Burst Power)	377
RF Envelope	377
Combined	378
Trace	378
Meas Setup (Complementary Cumulative Distribution Function—CCDF)	381
Meas BW	381

Contents

Counts	382
Meas Interval	382
Optimize Ref Level	383
Display (Complementary Cumulative Distribution Function—CCDF)	385
Full Screen	385
Store Ref Trace	385
Ref Trace	386
Gaussian Trace	386
Preferences	386
SPAN X Scale (Complementary Cumulative Distribution Function—CCDF)	389
Scale/Div	389
Marker (Complementary Cumulative Distribution Function—CCDF)	391
Select Marker	392
Normal	392
Delta	392
Off	394
Marker Trace	394
Marker All Off	394
Marker X Position	395
Marker Y Position (Remote Command Only)	396
Marker Maximum and Minimum (Remote Command Only)	397
Meas Setup (Channel Power—CHP)	399
Avg Number	399
Avg Mode	400
Integ BW	400
Chan Pwr Span	401
Optimize Ref Level	402
RRC Filter	402
Filter Alpha	402
Trace/View (Channel Power Measurement)	405
Spectrum	405
Combined	405
Trace	405
Meas Setup (Harmonic Distortion)	409
Avg Number	409
Avg Mode	409
Harmonics	410
ST/Harmonic	410
Range Table (On/Off)	412
Range Table	413
Optimize Ref Level	419
Trace/View (Harmonics)	421
Harmonics	421
Harmonics & THD	421
Meas Setup (Intermod (TOI))	423
Avg Number	423
Avg Mode	425
TOI Span	425
Max Mixer Lvl	426

Optimize Ref Level	426
Meas Setup (Multi-Carrier Power—MCP)	429
Avg Number	429
Avg Mode	430
Carrier Setup	430
Offsets/Limits	438
Carrier Result	441
Optimize Ref Level	441
Method	441
Power Ref	442
Limit Test	443
RRC Filter	444
Filter Alpha	444
Noise Correction	445
Trace/View (Multi-Carrier Power Measurement)	447
Spectrum	447
Combined	447
Combined View Units	448
Trace	448
Meas Setup (Occupied Bandwidth—OBW)	451
Avg Number	451
Avg Mode	452
Max Hold	452
Occ BW % Pwr	454
OBW Span	454
x dB	455
Optimize Ref Level	456
Meas Setup (Spectrum Emissions Mask—SEM)	457
Avg Number	457
Meas Type	458
Ref Channel	458
Offset/Limits	462
Optimize Ref Level	475
RRC Filter	475
Filter Alpha	476
Trace/View (Spectrum Emissions Mask)	477
Abs Pwr & Freq	477
Rel Pwr & Freq	477
Integrated Power	478
Display (Spectrum Emissions Mask—SEM)	479
Full Screen	479
Limit Display	479
Preferences	479
SPAN X Scale (Spectrum Emissions Mask—SEM)	481
Scale/Div	481
Ref Value	481
Ref Position	481
Marker (Spectrum Emissions Mask—SEM)	483
Select Marker	483

Contents

Normal	484
Off	484
Meas Setup (Spurious Emissions)	485
Avg Number	485
Avg Mode	486
Range Table	486
Meas Type	497
Spur	498
Ref Level	498
Fast Spurious Meas	499
6. Programming Fundamentals	
SCPI Language Basics	503
Command Keywords and Syntax	503
Creating Valid Commands	504
Special Characters in Commands	505
Parameters in Commands	506
Putting Multiple Commands on the Same Line	508
Improving Measurement Speed	511
Turn off the display updates	511
Use binary data format instead of ASCII	512
Minimize the number of GPIB transactions	512
Avoid unnecessary use of *RST	513
Put ADC Ranging in Bypass for FFT Measurements	513
Minimize DUT/instrument setup changes	513
Consider using LAN instead of GPIB	514
Using an Option Mode: Minimize the number of GPIB transactions	514
Using an Option Mode: Avoid automatic attenuator setting	515
Using an Option Mode: Optimize your GSM output RF spectrum switching measurement ..	515
Using an Option Mode: Avoid using RFBurst trigger for single burst signals	515
Using an Option Mode: When making power measurements on multiple bursts or slots, use CALCulate:DATA<n>:COMPRESS?	516
Programming Command Compatibility	
Across Model Numbers and Across Modes	519
Across PSA Modes: Command Subsystem Similarities	519
Across PSA Modes: Specific Command Differences	521
Using Applications in PSA Series vs. VSA E4406A	522
Using the LAN to Control the Instrument	524
Using ftp for File Transfers	524
Using Telnet to Send Commands	527
Using Socket LAN to Send Commands	530
Using SICL LAN to Control the Instrument	531
Using HP/Agilent VEE Over Socket LAN	536
Using a Java™ Applet Over Socket LAN	538
Using a C Program Over Socket LAN	538
General LAN Troubleshooting	538
Programming in C Using the VTL	546
Typical Example Program Contents	546

Linking to VTL Libraries	547
Compiling and Linking a VTL Program	547
Example Program	549
Including the VISA Declarations File	549
Opening a Session	549
Device Sessions	550
Addressing a Session	551
Closing a Session	553
Overview of the GPIB Bus	554
GPIB Command Statements	554
7. Using the STATUS System	
Status System Commands	559
Common IEEE Commands	563
Calibration Query	563
Clear Status	563
Standard Event Status Enable	563
Standard Event Status Register Query	564
Identification Query	564
Instrument State Query	564
Operation Complete	565
Query Instrument Options	565
Power-On Status Clear	566
Recall	566
Reset	566
Save	567
Service Request Enable	567
Read Status Byte Query	567
Trigger	568
Self Test Query	568
Wait-to-Continue	568
STATUS Subsystem	571
Operation Register	571
Preset the Status Byte	573
Questionable Register	573
Questionable Calibration Register	575
Questionable Frequency Register	576
Questionable Integrity Register	578
Questionable Integrity Signal Register	580
Questionable Integrity Uncalibrated Register	582
Questionable Power Register	583
Questionable Temperature Register	585
8. Menu Maps: Spectrum Analysis	
Alpha Editor Keys, 1 of 2	588
AMPLITUDE Y Scale Key, 1 of 2 (See page 49)	590
Auto Couple Key, 1 of 3 (See page 71)	592
BW/Avg Key (See page 83)	595

Contents

Det/Demod Key (See page 95)596
Display Key, 1 of 2 (See page 103)597
File Key, 1 of 6 (See page 127)599
FREQUENCY Channel Key (See page 163)605
Input/Output Key (See page 171)606
Marker Key (See page 177)607
Marker --> Key (See page 197)608
Marker Fctn Key (See page 191)609
MODE Key (See page 203)610
Peak Search Key (See page 209)611
Preset Key (See page 221)612
Print Setup Key (See page 229)613
SPAN X Scale Key (See page 237)614
SPAN X Scale Key for CCDF Measurement (See page 389)615
Sweep Key (See page 241)616
System Key, 1 of 4 (See page 247)617
Trace/View Key (See page 283)621
Trig Key (See page 287)622

9. Menu Maps:

One-Button Measurement Functions

One-Button Measurement Menu Maps624
MEASURE Key625
Meas Control Key626
Mode Setup Key627
Mode Setup Key (2 of 2)628
ACP Measurement: Meas Setup Key629
ACP Measurement: Trace/View Key630
Burst Power Measurement: Meas Setup Key631
Burst Power Measurement: Trace/View Key632
CCDF (Power Stat) Measurement: Meas Setup Key633
CCDF (Power Stat) Measurement: Trace/View Key634
CCDF (Power Stat) Measurement: Display Key635
CCDF (Power Stat) Measurement: Span X Scale Key636
CCDF (Power Stat) Measurement: Marker Key637
Channel Power Measurement: Meas Setup Key638
Channel Power Measurement: Trace/View Key639
Harmonic Distortion Measurement: Meas Setup Key640
Harmonic Distortion Measurement: Trace/View Key641
Intermod (TOI): Meas Setup Key642
Multi-Carrier Power Measurement: Meas Setup Key643
Multi-Carrier Power Measurement: Trace/View Key644
Occupied Bandwidth Measurement: Meas Setup Key645
Spectrum Emission Mask Measurement: Meas Setup Key646
Spectrum Emission Mask Measurement: Trace/View Key647
Spectrum Emission Mask Measurement: Display Key648
Spectrum Emission Mask Measurement: Span X Scale Key649
Spectrum Emission Mask Measurement: Marker Key650
Spurious Emissions Measurement: Meas Setup Key651

List of Commands

*CAL?	563
*CLS	248
*CLS	563
*ESE <number>	563
*ESE?	563
*ESR?	564
*IDN?	564
*OPC	565
*OPC?	565
*PSC	566
*PSC?	566
*RCL <register>	566
*RST	566
*SAV <register>	567
*SRE <integer>	567
*SRE?	567
*STB?	567
*TRG	568
*TST?	257
*TST?	568
*WAI	568
:ABORT	331
:CALCulate:ACPower:OFFSet:LIST:LIMit:NEGative[:UPPer]:DATA <rel_power>,<rel_power>,<rel_power>,<rel_power>,<rel_power>,<rel_power>	359
:CALCulate:ACPower:OFFSet:LIST:LIMit:NEGative[:UPPer]:DATA?	359
:CALCulate:ACPower:OFFSet:LIST:LIMit:POSitive[:UPPer]:DATA <rel_power>,<rel_power>,<rel_power>,<rel_power>,<rel_power>,<rel_power>	359
:CALCulate:ACPower:OFFSet:LIST:LIMit:POSitive[:UPPer]:DATA?	359
:CALCulate:BANDwidth:NDB <dB_value>	214
:CALCulate:BANDwidth:NDB?	214
:CALCulate:BANDwidth[:STATe] ON OFF 1 0	214
:CALCulate:BANDwidth[:STATe]?	214

List of Commands

:CALCulate:LLINE:ALL:DELeTe.	122
:CALCulate:LLINE:CMODE FIXEd RELative	121
:CALCulate:LLINE:CMODE?	121
:CALCulate:LLINE:CONTRol:DOMain FREQUency TIME	120
:CALCulate:LLINE:CONTRol:DOMain?	120
:CALCulate:LLINE[1] 2:AMPLitude:INTerpolate:TYPE LOGarithmic LINear	119
:CALCulate:LLINE[1] 2:AMPLitude:INTerpolate:TYPE?	119
:CALCulate:LLINE[1] 2:CONTRol:INTerpolate:TYPE LOGarithmic LINear	119
:CALCulate:LLINE[1] 2:CONTRol:INTerpolate:TYPE?	119
:CALCulate:LLINE[1] 2:DATA <x-axis>, <ampl>, <connected>{,<x-axis>,<ampl>,<connected>}	109
:CALCulate:LLINE[1] 2:DATA:MERGe <x-axis>, <ampl>, <connected>{,<x-axis>,<ampl>,<connected>}	109
:CALCulate:LLINE[1] 2:DATA?	109
:CALCulate:LLINE[1] 2:DELeTe.	116
:CALCulate:LLINE[1] 2:DISPlay	111
:CALCulate:LLINE[1] 2:DISPlay?	111
:CALCulate:LLINE[1] 2:FAIL?	111
:CALCulate:LLINE[1] 2:MARGin <ampl_rel>.	113
:CALCulate:LLINE[1] 2:MARGin:STATe OFF ON 0 1	112
:CALCulate:LLINE[1] 2:MARGin:STATe?.	112
:CALCulate:LLINE[1] 2:MARGin?	113
:CALCulate:LLINE[1] 2:STATe OFF ON 0 1	111
:CALCulate:LLINE[1] 2:STATe?.	111
:CALCulate:LLINE[1] 2:TYPE UPPer LOWer	110
:CALCulate:LLINE[1] 2:TYPE?	110
:CALCulate:MARKer:AOFF	189
:CALCulate:MARKer:FCOunt:GATetime <time>	196
:CALCulate:MARKer:FCOunt:GATetime:AUTO OFF ON 0 1	196
:CALCulate:MARKer:FCOunt:GATetime:AUTO?	196
:CALCulate:MARKer:FCOunt:GATetime?	196
:CALCulate:MARKer:PEAK[1] 2 3 4:SEARCh:MODE PARAmeter MAXimum.	218

List of Commands

:CALCulate:MARKer:PEAK[1] 2 3 4:SEARch:MODE?	218
:CALCulate:MARKer:TABLE:STATe OFF ON 0 1	189
:CALCulate:MARKer:TABLE:STATe?	189
:CALCulate:MARKer[1] 2 3 4:CPEak[:STATe] OFF ON 0 1	212
:CALCulate:MARKer[1] 2 3 4:CPEak[:STATe]?	213
:CALCulate:MARKer[1] 2 3 4:FCOunt:X?	195
:CALCulate:MARKer[1] 2 3 4:FCOunt[:STATe] OFF ON 0 1	195
:CALCulate:MARKer[1] 2 3 4:FCOunt[:STATe]?	195
:CALCulate:MARKer[1] 2 3 4:FUNcTion BPOWer NOISe OFF	191
:CALCulate:MARKer[1] 2 3 4:FUNcTion?	191
:CALCulate:MARKer[1] 2 3 4:MAXimum	209
:CALCulate:MARKer[1] 2 3 4:MAXimum:LEFT	210
:CALCulate:MARKer[1] 2 3 4:MAXimum:NEXT	210
:CALCulate:MARKer[1] 2 3 4:MAXimum:RIGHT	210
:CALCulate:MARKer[1] 2 3 4:MINimum	211
:CALCulate:MARKer[1] 2 3 4:MODE POSition DELTA BAND SPAN OFF	179
:CALCulate:MARKer[1] 2 3 4:MODE?	179
:CALCulate:MARKer[1] 2 3 4:PEAK:EXcursion <rel_amplitude>	215
:CALCulate:MARKer[1] 2 3 4:PEAK:EXcursion?	215
:CALCulate:MARKer[1] 2 3 4:PEAK:THReshold?	216
:CALCulate:MARKer[1] 2 3 4:PTPeak	212
:CALCulate:MARKer[1] 2 3 4:STATe OFF ON 0 1	180
:CALCulate:MARKer[1] 2 3 4:STATe?	180
:CALCulate:MARKer[1] 2 3 4:TRACe 1 2 3	186
:CALCulate:MARKer[1] 2 3 4:TRACe:AUTO OFF ON 0 1	186
:CALCulate:MARKer[1] 2 3 4:TRACe:AUTO?	186
:CALCulate:MARKer[1] 2 3 4:TRACe?	186
:CALCulate:MARKer[1] 2 3 4:TRCKing[:STATe] OFF ON 0 1	170
:CALCulate:MARKer[1] 2 3 4:TRCKing[:STATe]?	170
:CALCulate:MARKer[1] 2 3 4:X <param>	179
:CALCulate:MARKer[1] 2 3 4:X:CENTer <param>	185

List of Commands

:CALCulate:MARKer[1] 2 3 4:X:CENTer?	185
:CALCulate:MARKer[1] 2 3 4:X:POSition:CENTer <param>	184
:CALCulate:MARKer[1] 2 3 4:X:POSition:CENTer?	184
:CALCulate:MARKer[1] 2 3 4:X:POSition:SPAN <param>	185
:CALCulate:MARKer[1] 2 3 4:X:POSition:SPAN?	185
:CALCulate:MARKer[1] 2 3 4:X:POSition:STARt <param>	182
:CALCulate:MARKer[1] 2 3 4:X:POSition:STARt?.	182
:CALCulate:MARKer[1] 2 3 4:X:POSition:STOP <param>	182
:CALCulate:MARKer[1] 2 3 4:X:POSition:STOP?	182
:CALCulate:MARKer[1] 2 3 4:X:READout FREQuency TIME ITIME PERiod.	186
:CALCulate:MARKer[1] 2 3 4:X:READout?	187
:CALCulate:MARKer[1] 2 3 4:X:SPAN <param>	185
:CALCulate:MARKer[1] 2 3 4:X:SPAN?	185
:CALCulate:MARKer[1] 2 3 4:X?	179
:CALCulate:MARKer[1] 2 3 4:Y?	179
:CALCulate:MARKer[1] 2 3 4[:SET]:CENTer.	197
:CALCulate:MARKer[1] 2 3 4[:SET]:DELTA:CENTer	199
:CALCulate:MARKer[1] 2 3 4[:SET]:DELTA:SPAN	199
:CALCulate:MARKer[1] 2 3 4[:SET]:RLEVel	200
:CALCulate:MARKer[1] 2 3 4[:SET]:STARt.	197
:CALCulate:MARKer[1] 2 3 4[:SET]:STEP.	197
:CALCulate:MARKer[1] 2 3 4[:SET]:STOP.	199
:CALCulate:MCPower:OFFSet:LIST:LIMit:NEGative[:UPPer]:DATA <dB>,<dB>,<dB>	440
:CALCulate:MCPower:OFFSet:LIST:LIMit:NEGative[:UPPer]:DATA?	440
:CALCulate:MCPower:OFFSet:LIST:LIMit:POSitive[:UPPer]:DATA <dB>,<dB>,<dB>	440
:CALCulate:MCPower:OFFSet:LIST:LIMit:POSitive[:UPPer]:DATA?	440
:CALCulate:PStatistic:MARKer[1] 2 3 4:MAXimum.	397
:CALCulate:PStatistic:MARKer[1] 2 3 4:MINimum	397
:CALCulate:PStatistic:MARKer[1] 2 3 4:MODE NORMal DELTA OFF	391
:CALCulate:PStatistic:MARKer[1] 2 3 4:MODE?	391
:CALCulate:PStatistic:MARKer[1] 2 3 4:TRACe MEASured GAUSSian REFerence	394

List of Commands

:CALCulate:PStatistic:MARKer[1] 2 3 4:TRACe?	394
:CALCulate:PStatistic:MARKer[1] 2 3 4:X <dB>	395
:CALCulate:PStatistic:MARKer[1] 2 3 4:X:POSition <dB>	395
:CALCulate:PStatistic:MARKer[1] 2 3 4:X:POSition?	395
:CALCulate:PStatistic:MARKer[1] 2 3 4:X?	395
:CALCulate:PStatistic:MARKer[1] 2 3 4:Y?	397
:CALCulate:PStatistic:MARKer[1] 2 3 4[:STATe] OFF ON 0 1	392
:CALCulate:PStatistic:MARKer[1] 2 3 4[:STATe]?	392
:CALCulate:PStatistic:STORe:REFerence	385
:CALCulate:SEMAsk:MARKer[1] 2 3 4:STATe OFF ON 0 1	483
:CALCulate:SEMAsk:MARKer[1] 2 3 4:STATe?	483
:CALCulate:SPURious[:RANGe][:LIST]:LIMit:ABSolute[:UPPER]:DATA:STARt <integer>	493
:CALCulate:SPURious[:RANGe][:LIST]:LIMit:ABSolute[:UPPER]:DATA:STARt?	493
:CALCulate:SPURious[:RANGe][:LIST]:LIMit:ABSolute[:UPPER]:DATA:STOP <integer>,<integer>	495
:CALCulate:SPURious[:RANGe][:LIST]:LIMit:ABSolute[:UPPER]:DATA:STOP:AUTO OFF ON 0 1, OFF ON 0 1	495
:CALCulate:SPURious[:RANGe][:LIST]:LIMit:ABSolute[:UPPER]:DATA:STOP?	495
:CALibration:ADC	259
:CALibration:ADC?	259
:CALibration:AUTO OFF ON ALERt	257
:CALibration:AUTO?	257
:CALibration:DATA:DEFault	261
:CALibration:DISPlay:LEVel OFF LOW HIGH	262
:CALibration:DISPlay:LEVel?	262
:CALibration:FLATness:IF	260
:CALibration:FLATness:IF?	260
:CALibration:FREQuency[:STATe] OFF ON 0 1	258
:CALibration:FREQuency[:STATe]?	258
:CALibration:GAIN:CSYStem	261
:CALibration:GAIN:CSYStem?	261
:CALibration:IF	259

List of Commands

:CALibration:IF?	.259
:CALibration:RF	.258
:CALibration:RF?	.258
:CALibration:TCORrections AUTO ON OFF	.262
:CALibration[:ALL]	.257
:CALibration[:ALL]?	.257
:CONFigure:ACPower	.306
:CONFigure:BPOWer	.320
:CONFigure:CHPower	.303
:CONFigure:HARMonics	.316
:CONFigure:MCP	.310
:CONFigure:OBW	.304
:CONFigure:PStatistic	.314
:CONFigure:SANalyzer	.300
:CONFigure:SEMask	.324
:CONFigure:SPURious	.322
:CONFigure:TOIN	.321
:CONFigure?	.328
:COUple ALL NONE	.72
:COUple?	.72
:DISPlay:AFUNction:POSition BOTtom	.108
:DISPlay:AFUNction:POSition BOTtom CENTer TOP	.106
:DISPlay:AFUNction:POSition CENTer	.107
:DISPlay:AFUNction:POSition TOP	.107
:DISPlay:AFUNction:POSition?	.106
:DISPlay:ANNotation:CLOCK:DATE:FORMat MDY DMY	.253
:DISPlay:ANNotation:CLOCK:DATE:FORMat?	.253
:DISPlay:ANNotation:CLOCK[:STATE] ON OFF	.253
:DISPlay:ANNotation:CLOCK[:STATE]?	.253
:DISPlay:ANNotation:TITLe:DATA <string>	.122
:DISPlay:ANNotation:TITLe:DATA?	.122

List of Commands

:DISPlay:ENABle OFF ON 0 1	125
:DISPlay:ENABle?	125
:DISPlay:FSCReen[:STATe] OFF ON 0 1	103
:DISPlay:FSCReen[:STATe]?	103
:DISPlay:PSTatistic:GAUSSian[:STATe] OFF ON 0 1	386
:DISPlay:PSTatistic:GAUSSian[:STATe]?	386
:DISPlay:PSTatistic:REFerence[:STATe] OFF ON 0 1	386
:DISPlay:PSTatistic:REFerence[:STATe]?	386
:DISPlay:PSTatistic:XSCale<rel_ampl>	389
:DISPlay:PSTatistic:XSCale?	389
:DISPlay:WINDow:ANNOtation[:ALL] OFF ON 0 1	125
:DISPlay:WINDow:ANNOtation[:ALL]?	125
:DISPlay:WINDow:TRACe:Y:DLINe <ampl>	104
:DISPlay:WINDow:TRACe:Y:DLINe <ampl>	104
:DISPlay:WINDow:TRACe:Y:DLINe:STATe OFF ON 0 1	104
:DISPlay:WINDow:TRACe:Y:DLINe:STATe OFF ON 0 1	104
:DISPlay:WINDow:TRACe:Y:DLINe:STATe?	104
:DISPlay:WINDow:TRACe:Y:DLINe:STATe?	104
:DISPlay:WINDow:TRACe:Y:DLINe?	104
:DISPlay:WINDow:TRACe:Y:DLINe?	104
:DISPlay:WINDow[1]:TRACe:Y:[SCALe]:PDIVision <power>	52
:DISPlay:WINDow[1]:TRACe:Y:[SCALe]:PDIVision?	52
:DISPlay:WINDow[1]:TRACe:Y:[SCALe]:RLEVel <ampl>	49
:DISPlay:WINDow[1]:TRACe:Y:[SCALe]:RLEVel:OFFSet <rel_power>	59
:DISPlay:WINDow[1]:TRACe:Y:[SCALe]:RLEVel:OFFSet?	59
:DISPlay:WINDow[1]:TRACe:Y:[SCALe]:RLEVel?	49
:DISPlay:WINDow[1]:TRACe:Y:[SCALe]:SPACing LINear LOGarithmic	54
:DISPlay:WINDow[1]:TRACe:Y:[SCALe]:SPACing?	54
:FETCh:ACPower[n]?	306
:FETCh:BPOWer[n]?	320
:FETCh:CHPower:CHPower?	303

List of Commands

:FETCh:CHPower:DENSity?	.303
:FETCh:CHPower?	.303
:FETCh:HARMonics:AMPLitude:ALL?	.316
:FETCh:HARMonics:AMPLitude[n]?	.316
:FETCh:HARMonics:FREQuency:ALL?	.316
:FETCh:HARMonics:FREQuency[n]?	.317
:FETCh:HARMonics:FUNDamental?	.317
:FETCh:HARMonics[:DISTortion]?	.316
:FETCh:HARMonics[n]?	.317
:FETCh:MCP[n]?	.310
:FETCh:MCPower?	.310
:FETCh:MCPower?	.311
:FETCh:OBW:FERRor?	.304
:FETCh:OBW:OBWidth?	.304
:FETCh:OBW:XDB?	.304
:FETCh:OBW?	.304
:FETCh:PStatistic[n]?	.314
:FETCh:SEMAsk[n]?	.324
:FETCh:SPURious[n]?	.322
:FETCh:TOIN:IP2?	.321
:FETCh:TOIN:IP3?	.321
:FETCh:TOIN?	.321
:FORMat:BORDER NORMAl SWAPped	.160
:FORMat:BORDER?	.160
:FORMat[:TRACe][:DATA] ASCii INTeger,32 REAL,32 REAL,64 UINTegeR,16	.161
:FORMat[:TRACe][:DATA]?	.161
:HCOPy:ABORt	.227
:HCOPy:DEVice:COLor NO YES	.230
:HCOPy:DEVice:COLor?	.230
:HCOPy:DEVice:LANGUage PCL3 PCL5	.230
:HCOPy:DEVice:LANGUage?	.230

List of Commands

:HCOPY:IMAGe:COLor[:STATe] OFF ON 0 1	234
:HCOPY:IMAGe:COLor[:STATe]?	234
:HCOPY:ITEM:FFEed[:IMMediate]	232
:HCOPY:PAGE:ORientation LANDscape PORTRait	231
:HCOPY:PAGE:ORientation?	231
:HCOPY:PAGE:PRINts <integer>	232
:HCOPY:PAGE:PRINts?	232
:HCOPY:PAGE:SIZE A B A3 A4 LETTer LEGal EXECutive LEDGer	232
:HCOPY:PAGE:SIZE?	233
:HCOPY[:IMMediate]	227
:INITiate:ACPower	306
:INITiate:BPOWER	320
:INITiate:CHPower	303
:INITiate:CONTinuous OFF ON 0 1	242
:INITiate:CONTinuous?	242
:INITiate:HARMonics	316
:INITiate:OBW	304
:INITiate:PAUSe	330
:INITiate:PStatistic	314
:INITiate:REStart	329
:INITiate:REStart	347
:INITiate:RESume	330
:INITiate:SEMAsk	324
:INITiate:SPURious	322
:INITiate:TOIN	321
:INITiate[:IMMediate]	331
:INITiate[:IMMediate]	349
:INPut:COUPling AC DC	172
:INPut:COUPling?	172
:INSTrument:CATalog?	206
:INSTrument:NSElect <integer>	205

List of Commands

:INSTrument:NSElect?205
:INSTrument[:SElect] BASIC CDMA CDMA1XEV CDMA2K EDGE GSM LINK NADC NFIG- URE PDC PNOISE SA WCDMA203
:INSTrument[:SElect]?203
:MEASure:ACPower[n]?306
:MEASure:BPOWer[n]?320
:MEASure:CHPower:CHPower?303
:MEASure:CHPower:DENSity?303
:MEASure:CHPower?303
:MEASure:HARMonics:AMPLitude:ALL?316
:MEASure:HARMonics:AMPLitude[n]?316
:MEASure:HARMonics:FREQuency:ALL?316
:MEASure:HARMonics:FREQuency[n]?317
:MEASure:HARMonics:FUNDamental?317
:MEASure:HARMonics[:DISTortion]?316
:MEASure:HARMonics[n]?317
:MEASure:MCP[n]?310
:MEASure:MCPower?310
:MEASure:MCPower?311
:MEASure:OBW:FERRor?304
:MEASure:OBW:OBWidth?304
:MEASure:OBW:XDB?304
:MEASure:OBW?304
:MEASure:PStatistic[n]?314
:MEASure:SEMAsk[n]?324
:MEASure:SPURious[n]?322
:MEASure:TOIN:IP2?321
:MEASure:TOIN:IP3?321
:MEASure:TOIN?321
:MMEMory:CATalog? <dir_name>130
:MMEMory:COpy <'file_name1'>,<'file_name2'>151

List of Commands

:MMEMory:DATA <file_name>,<definite_length_block>	158
:MMEMory:DATA? <file_name>	158
:MMEMory:DELeTe <file_name>	149
:MMEMory:LOAD:CORRection ANTenna CABLe OTHer USER,<file_name>.	144
:MMEMory:LOAD:LIMit LLINE1 LLINE2,<file_name>	144
:MMEMory:LOAD:STATe 1,<file_name>	144
:MMEMory:LOAD:TRACe <label>,<file_name>.	144
:MMEMory:MDIRectory <dir_name>	155
:MMEMory:MOVE <file_name1>,<file_name2>	153
:MMEMory:RDIRectory <directory_name>.	149
:MMEMory:STORe:CORRection ANTenna CABLe OTHer USER,<file_name>.	138
:MMEMory:STORe:LIMit LLINE1 LLINE2,<file_name>.	138
:MMEMory:STORe:RESults <file_name>	138
:MMEMory:STORe:SCReen <file_name>	138
:MMEMory:STORe:STATe 1,<file_name>.	138
:MMEMory:STORe:TRACe <label>,<file_name>	138
:READ:ACPower[n]?	306
:READ:BPOWer[n]?	320
:READ:CHPower:CHPower?	303
:READ:CHPower:DENSity?	303
:READ:CHPower?	303
:READ:HARMonics:AMPLitude:ALL?	316
:READ:HARMonics:AMPLitude[n]?	316
:READ:HARMonics:FREQuency:ALL?	316
:READ:HARMonics:FREQuency[n]?	317
:READ:HARMonics:FUNDamental?	317
:READ:HARMonics[:DISTortion]?	316
:READ:HARMonics[n]?	317
:READ:MCP[n]?	310
:READ:MCPower?	310
:READ:MCPower?	311

List of Commands

:READ:OBW:FERRor?	.304
:READ:OBW:OBWidth?	.304
:READ:OBW:XDB?	.304
:READ:OBW?	.304
:READ:PSTatistic[n]?	.314
:READ:SEMask[n]?	.324
:READ:SPURious[n]?	.322
:READ:TOIN:IP2?	.321
:READ:TOIN:IP3?	.321
:READ:TOIN?	.321
:STATus:OPERation:CONDition?	.571
:STATus:OPERation:ENABle <integer>	.571
:STATus:OPERation:ENABle?	.571
:STATus:OPERation:NTRansition <integer>	.572
:STATus:OPERation:NTRansition?	.572
:STATus:OPERation:PTRansition <integer>	.572
:STATus:OPERation:PTRansition?	.572
:STATus:OPERation[:EVENT]?	.572
:STATus:PRESet	.573
:STATus:QUEStionable:CALibration:CONDition?	.575
:STATus:QUEStionable:CALibration:ENABle <number>	.575
:STATus:QUEStionable:CALibration:ENABle?	.575
:STATus:QUEStionable:CALibration:NTRansition <number>	.576
:STATus:QUEStionable:CALibration:NTRansition?	.576
:STATus:QUEStionable:CALibration:PTRansition <number>	.576
:STATus:QUEStionable:CALibration:PTRansition?	.576
:STATus:QUEStionable:CALibration[:EVENT]?	.575
:STATus:QUEStionable:CONDition?	.573
:STATus:QUEStionable:ENABle <number>	.573
:STATus:QUEStionable:ENABle?	.573
:STATus:QUEStionable:FREQuency:CONDition?	.576

List of Commands

:STATus:QUEStionable:FREQuency:ENABle <number>	577
:STATus:QUEStionable:FREQuency:ENABle?.	577
:STATus:QUEStionable:FREQuency:NTRansition <number>	577
:STATus:QUEStionable:FREQuency:NTRansition?.	577
:STATus:QUEStionable:FREQuency:PTRansition <number>.	578
:STATus:QUEStionable:FREQuency:PTRansition?	578
:STATus:QUEStionable:FREQuency[:EVENT]?	577
:STATus:QUEStionable:INTEGRity:CONDition?	578
:STATus:QUEStionable:INTEGRity:ENABle <number>	578
:STATus:QUEStionable:INTEGRity:ENABle?	578
:STATus:QUEStionable:INTEGRity:NTRansition <number>	579
:STATus:QUEStionable:INTEGRity:NTRansition?	579
:STATus:QUEStionable:INTEGRity:PTRansition <number>	579
:STATus:QUEStionable:INTEGRity:PTRansition?	579
:STATus:QUEStionable:INTEGRity:SIGNAL:CONDition?	580
:STATus:QUEStionable:INTEGRity:SIGNAL:ENABle <number>	580
:STATus:QUEStionable:INTEGRity:SIGNAL:ENABle?	580
:STATus:QUEStionable:INTEGRity:SIGNAL:NTRansition <number>	581
:STATus:QUEStionable:INTEGRity:SIGNAL:NTRansition?	581
:STATus:QUEStionable:INTEGRity:SIGNAL:PTRansition <number>.	581
:STATus:QUEStionable:INTEGRity:SIGNAL:PTRansition?	581
:STATus:QUEStionable:INTEGRity:SIGNAL[:EVENT]?	580
:STATus:QUEStionable:INTEGRity:UNCalibrated:CONDition?	582
:STATus:QUEStionable:INTEGRity:UNCalibrated:ENABle	582
:STATus:QUEStionable:INTEGRity:UNCalibrated:ENABle?	582
:STATus:QUEStionable:INTEGRity:UNCalibrated:NTRansition <number>	583
:STATus:QUEStionable:INTEGRity:UNCalibrated:NTRansition?	583
:STATus:QUEStionable:INTEGRity:UNCalibrated:PTRansition <number>	583
:STATus:QUEStionable:INTEGRity:UNCalibrated:PTRansition?	583
:STATus:QUEStionable:INTEGRity:UNCalibrated[:EVENT]?	582
:STATus:QUEStionable:INTEGRity[:EVENT]?	579

List of Commands

:STATus:QUESTionable:NTRansition <number>574
:STATus:QUESTionable:NTRansition?574
:STATus:QUESTionable:POWer:CONDition?583
:STATus:QUESTionable:POWer:ENABle <number>584
:STATus:QUESTionable:POWer:ENABle?584
:STATus:QUESTionable:POWer:NTRansition <number>584
:STATus:QUESTionable:POWer:NTRansition?584
:STATus:QUESTionable:POWer:PTRansition <number>585
:STATus:QUESTionable:POWer:PTRansition?>.585
:STATus:QUESTionable:POWer[:EVENT]?584
:STATus:QUESTionable:PTRansition <number>.574
:STATus:QUESTionable:PTRansition?574
:STATus:QUESTionable:TEMPerature:CONDition?585
:STATus:QUESTionable:TEMPerature:ENABle <number>585
:STATus:QUESTionable:TEMPerature:ENABle?585
:STATus:QUESTionable:TEMPerature:NTRansition <number>586
:STATus:QUESTionable:TEMPerature:NTRansition?586
:STATus:QUESTionable:TEMPerature:PTRansition <number>.586
:STATus:QUESTionable:TEMPerature:PTRansition?586
:STATus:QUESTionable:TEMPerature[:EVENT]?586
:STATus:QUESTionable[:EVENT]?574
:SYSTem:COMMunicate:GPIB[:SELf]:ADDRes <integer>263
:SYSTem:COMMunicate:GPIB[:SELf]:ADDRes?263
:SYSTem:COMMunicate:LAN:SCPI:SICL:ENABle OFF ON 0 1267
:SYSTem:COMMunicate:LAN:SCPI:SICL:ENABle?267
:SYSTem:COMMunicate:LAN:SCPI:SOCKet:ENABle OFF ON 0 1266
:SYSTem:COMMunicate:LAN:SCPI:SOCKet:ENABle?266
:SYSTem:COMMunicate:LAN:SCPI:TELNet:ENABle OFF ON 0 1266
:SYSTem:COMMunicate:LAN:SCPI:TELNet:ENABle?266
:SYSTem:COMMunicate:LAN[:SELf]:IP <string>263
:SYSTem:COMMunicate:LAN[:SELf]:IP?263

List of Commands

:SYSTem:CONF:HARD ON OFF	271
:SYSTem:DATE <year>,<month>,<day>	255
:SYSTem:DATE?	255
:SYSTem:ERRor[:NEXT]?	248
:SYSTem:HID?	264
:SYSTem:KLOCK?	280
:SYSTem:LKEY <"option">, <"license key">	277
:SYSTem:LKEY:DELeTe <'application option'>,<'license key'>	278
:SYSTem:LKEY? <"option">	277
:SYSTem:MESSage <string>	280
:SYSTem:MESSage:OFF	281
:SYSTem:OPTions?	270
:SYSTem:PON:ETime?	281
:SYSTem:PON:TYPE PRESet LAST	249
:SYSTem:PON:TYPE?	249
:SYSTem:PRESet	222
:SYSTem:PRESet:PERsistent	276
:SYSTem:PRESet:TYPE FACToRY USER MODE	250
:SYSTem:PRESet:TYPE?	250
:SYSTem:PRESet[:USER]:SAVE	252
:SYSTem:TIME <hour>,<minute>,<second>	254
:SYSTem:TIME:ADJust <seconds>	254
:SYSTem:TIME?	254
:SYSTem:VERsion?	281
:TRACe[:DATA]? <trace_name>	284
:TRACe[:DATA]? TRACE1 TRACE2 TRACE3 LLINE1 LLINE2	158
:TRACe[1] 2 3:MODE WRITe MAXHold MINHold VIEW BLANk	283
:TRACe[1] 2 3:MODE WRITe MAXHold MINHold VIEW BLANk	369
:TRACe[1] 2 3:MODE WRITe MAXHold MINHold VIEW BLANk	378
:TRACe[1] 2 3:MODE WRITe MAXHold MINHold VIEW BLANk	406
:TRACe[1] 2 3:MODE WRITe MAXHold MINHold VIEW BLANk	448

List of Commands

:TRACe[1] 2 3:MODE?283
:TRACe[1] 2 3:MODE?369
:TRACe[1] 2 3:MODE?379
:TRACe[1] 2 3:MODE?406
:TRACe[1] 2 3:MODE?448
:TRIGger[:SEQuence]:DELay <time>290
:TRIGger[:SEQuence]:DELay:STATe OFF ON 0 1290
:TRIGger[:SEQuence]:DELay:STATe?290
:TRIGger[:SEQuence]:DELay?290
:TRIGger[:SEQuence]:OFFSet <time>291
:TRIGger[:SEQuence]:OFFSet:STATe OFF ON 0 1291
:TRIGger[:SEQuence]:OFFSet:STATe?291
:TRIGger[:SEQuence]:OFFSet?291
:TRIGger[:SEQuence]:SLOPe POSitive NEGative290
:TRIGger[:SEQuence]:SLOPe?290
:TRIGger[:SEQuence]:SOURce IMMEDIATE VIDEO LINE EXTERNAL[1] EXTERNAL2 RFBURST287
:TRIGger[:SEQuence]:SOURce?287
:TRIGger[:SEQuence]:VIDeo:LEVel <ampl>288
:TRIGger[:SEQuence]:VIDeo:LEVel:FREQuency <freq>288
:TRIGger[:SEQuence]:VIDeo:LEVel:FREQuency?288
:TRIGger[:SEQuence]:VIDeo:LEVel?288
:UNIT:POWer DBM DBMV DBUV V W56
:UNIT:POWer?56
[:SENSe]:CORRection:IMPedance[:INPut][:MAGNitude] 50 75173
[:SENSe]:CORRection:IMPedance[:INPut][:MAGNitude]?173
[:SENSe]:ACPower:AVERage:COUNt <integer>351
[:SENSe]:ACPower:AVERage:COUNt?351
[:SENSe]:ACPower:AVERage:TCONrol EXPonential REPeat353
[:SENSe]:ACPower:AVERage:TCONrol?353
[:SENSe]:ACPower:AVERage[:STATe] OFF ON 0 1351
[:SENSe]:ACPower:AVERage[:STATe]?351

List of Commands

[[:SENSE]:ACPower:BANDwidth BWIDth:INTegration <freq>	354
[[:SENSE]:ACPower:BANDwidth BWIDth:INTegration?	354
[[:SENSE]:ACPower:CARRier:AUTO[:STATe] OFF ON 0 1	362
[[:SENSE]:ACPower:CARRier:AUTO[:STATe]?	362
[[:SENSE]:ACPower:CARRier:CPSD <dBm>	362
[[:SENSE]:ACPower:CARRier:CPSD?	362
[[:SENSE]:ACPower:CARRier[:POWer]	362
[[:SENSE]:ACPower:CORRection:NOISe[:AUTO] OFF ON 0 1	365
[[:SENSE]:ACPower:CORRection:NOISe[:AUTO]?	365
[[:SENSE]:ACPower:FILTer[:RRC]:ALPHA <number>	364
[[:SENSE]:ACPower:FILTer[:RRC][:STATe] OFF ON 0 1	364
[[:SENSE]:ACPower:LIMit[:STATe] OFF ON 0 1	363
[[:SENSE]:ACPower:LIMit[:STATe]?	363
[[:SENSE]:ACPower:METHod IBW RBW	360
[[:SENSE]:ACPower:METHod?	360
[[:SENSE]:ACPower:OFFSet:LIST:BANDwidth BWIDth[:INTegration] <bw>,<bw>,<bw>,<bw>,<bw>,<bw>	357
[[:SENSE]:ACPower:OFFSet:LIST:BANDwidth BWIDth[:INTegration]?	357
[[:SENSE]:ACPower:OFFSet:LIST:STATE OFF ON 0 1, OFF ON 0 1, OFF ON 0 1, OFF ON 0 1, OFF ON 0 1, OFF ON 0 1	356
[[:SENSE]:ACPower:OFFSet:LIST:STATE?	356
[[:SENSE]:ACPower:OFFSet:LIST[:FREQuency] <f_offset>,<f_offset>,<f_offset>,<f_offset>,<f_offset>,<f_offset>	356
[[:SENSE]:ACPower:OFFSet:LIST[:FREQuency]?	356
[[:SENSE]:ACPower:TYPE PSDRef TPref	359
[[:SENSE]:ACPower:TYPE?	360
[[:SENSE]:ADC:DITHer[:STATe] OFF ON AUTO	79
[[:SENSE]:ADC:DITHer[:STATe]?	79
[[:SENSE]:ADC:RANGe AUTO NONE	81
[[:SENSE]:ADC:RANGe?	81
[[:SENSE]:AVERage:CLEar	89
[[:SENSE]:AVERage:COUNt <integer>	89

List of Commands

[:SENSe]:AVERage:COUNt?89
[:SENSe]:AVERage:TYPE RMS LOG SCALar90
[:SENSe]:AVERage:TYPE:AUTO OFF ON 0 190
[:SENSe]:AVERage:TYPE:AUTO?90
[:SENSe]:AVERage:TYPE?90
[:SENSe]:AVERage[:STATe] OFF ON 0 189
[:SENSe]:AVERage[:STATe]?89
[:SENSe]:BANDwidth BWIDth:VIDeo <freq>86
[:SENSe]:BANDwidth BWIDth:VIDeo:AUTO OFF ON 0 186
[:SENSe]:BANDwidth BWIDth:VIDeo:AUTO?86
[:SENSe]:BANDwidth BWIDth:VIDeo:RATio <number>87
[:SENSe]:BANDwidth BWIDth:VIDeo:RATio:AUTO OFF ON 0 187
[:SENSe]:BANDwidth BWIDth:VIDeo:RATio:AUTO?87
[:SENSe]:BANDwidth BWIDth:VIDeo:RATio?87
[:SENSe]:BANDwidth BWIDth:VIDeo?.86
[:SENSe]:BANDwidth BWIDth[:RESolution] <freq>84
[:SENSe]:BANDwidth BWIDth[:RESolution]:AUTO OFF ON 0 184
[:SENSe]:BANDwidth BWIDth[:RESolution]:AUTO?84
[:SENSe]:BANDwidth BWIDth[:RESolution]?84
[:SENSe]:BPOWer:AVERage:COUNt <integer>371
[:SENSe]:BPOWer:AVERage:COUNt?371
[:SENSe]:BPOWer:AVERage:TCONrol EXPonential REPeat372
[:SENSe]:BPOWer:AVERage:TCONrol?372
[:SENSe]:BPOWer:AVERage:TYPE LPOWer POWer372
[:SENSe]:BPOWer:AVERage:TYPE?373
[:SENSe]:BPOWer:AVERage[:STATe] OFF ON 0 1371
[:SENSe]:BPOWer:AVERage[:STATe]?371
[:SENSe]:BPOWer:BURSt:AUTO OFF ON 0 1375
[:SENSe]:BPOWer:BURSt:AUTO?375
[:SENSe]:BPOWer:BURSt:WIDTh375
[:SENSe]:BPOWer:BURSt:WIDTh?375

List of Commands

[[:SENSe]:BPOWer:METhod THReshold BWIDth.	374
[[:SENSe]:BPOWer:METhod?	374
[[:SENSe]:BPOWer:THReshold <number>	373
[[:SENSe]:BPOWer:THReshold:TYPE ABSolute RELative	373
[[:SENSe]:BPOWer:THReshold:TYPE?	373
[[:SENSe]:BPOWer:THReshold?	373
[[:SENSe]:CHPower:AVErAge:COUNt <integer>	399
[[:SENSe]:CHPower:AVErAge:COUNt?	399
[[:SENSe]:CHPower:AVErAge:TCONrol EXPonential REPeat	400
[[:SENSe]:CHPower:AVErAge:TCONrol?	400
[[:SENSe]:CHPower:AVErAge[:STATe] OFF ON 0 1	399
[[:SENSe]:CHPower:AVErAge[:STATe]?	399
[[:SENSe]:CHPower:BANdwidth BWIDth:INtegration <freq>	401
[[:SENSe]:CHPower:BANdwidth BWIDth:INtegration?	401
[[:SENSe]:CHPower:FILTer[:RRC]:ALPHA <number>	404
[[:SENSe]:CHPower:FILTer[:RRC]:ALPHA?	404
[[:SENSe]:CHPower:FILTer[:RRC][:STATe] OFF ON 0 1	402
[[:SENSe]:CHPower:FILTer[:RRC][:STATe]?	402
[[:SENSe]:CHPower:FREQuency:SPAN <freq>	401
[[:SENSe]:CHPower:FREQuency:SPAN?	401
[[:SENSe]:CORRection:CSET:ALL:DELeTe	67
[[:SENSe]:CORRection:CSET:ALL[:STATe] OFF ON 0 1	61
[[:SENSe]:CORRection:CSET:ALL[:STATe]?	61
[[:SENSe]:CORRection:CSET[1] 2 3 4:DATA <freq>,<rel_ampl>{,<freq>,<rel_ampl>}	62
[[:SENSe]:CORRection:CSET[1] 2 3 4:DATA:MERGe <freq>,<rel_ampl>{,<freq>,<rel_ampl>} ..	62
[[:SENSe]:CORRection:CSET[1] 2 3 4:DATA?	63
[[:SENSe]:CORRection:CSET[1] 2 3 4:DELeTe	66
[[:SENSe]:CORRection:CSET[1] 2 3 4:X:SPACing LINear LOGarithmic	67
[[:SENSe]:CORRection:CSET[1] 2 3 4[:STATe] OFF ON 0 1	62
[[:SENSe]:CORRection:CSET[1] 2 3 4[:STATe]?	62
[[:SENSe]:CORRection:OFFSet[:MAGNitude] <relative_power>	68

List of Commands

[:SENSe]:CORRection:OFFSet[:MAGNitude]?	68
[:SENSe]:DETEctor:AUTO OFF ON 0 1	98
[:SENSe]:DETEctor:AUTO?	98
[:SENSe]:DETEctor[:FUNction] AVERAge NEGAtive NORMAl POSitive SAMPlE RMS	96
[:SENSe]:DETEctor[:FUNction]?	96
[:SENSe]:FEED RF AREFERENCE	171
[:SENSe]:FEED?	171
[:SENSe]:FREQuency:CENTer <frequency> UP DOWN	164
[:SENSe]:FREQuency:CENTer:STEP:AUTO OFF ON 0 1	167
[:SENSe]:FREQuency:CENTer:STEP:AUTO?	167
[:SENSe]:FREQuency:CENTer:STEP[:INCRement] <freq>	167
[:SENSe]:FREQuency:CENTer:STEP[:INCRement]?	167
[:SENSe]:FREQuency:CENTer?	164
[:SENSe]:FREQuency:OFFSet <freq>	168
[:SENSe]:FREQuency:OFFSet?	168
[:SENSe]:FREQuency:SPAN <freq>	238
[:SENSe]:FREQuency:SPAN:BANDwidth[:RESolution]:RATio <value>	93
[:SENSe]:FREQuency:SPAN:BANDwidth[:RESolution]:RATio:AUTO OFF ON 0 1	93
[:SENSe]:FREQuency:SPAN:BANDwidth[:RESolution]:RATio:AUTO?	93
[:SENSe]:FREQuency:SPAN:BANDwidth[:RESolution]:RATio?	93
[:SENSe]:FREQuency:SPAN:FULL	238
[:SENSe]:FREQuency:SPAN:PREVious	239
[:SENSe]:FREQuency:SPAN?	238
[:SENSe]:FREQuency:STARt <freq>	165
[:SENSe]:FREQuency:STARt?	165
[:SENSe]:FREQuency:STOP <frequency>	166
[:SENSe]:FREQuency:STOP?	166
[:SENSe]:FREQuency:SYNThesis 1 2 3	76
[:SENSe]:FREQuency:SYNThesis:AUTO OFF ON 0 1	76
[:SENSe]:FREQuency:SYNThesis:AUTO?	76
[:SENSe]:FREQuency:SYNThesis?	76

List of Commands

[:SENSe]:HARMonics:AVERage:COUNt <integer>	409
[:SENSe]:HARMonics:AVERage:COUNt?	409
[:SENSe]:HARMonics:AVERage:TCONrol EXPonential REPeat	410
[:SENSe]:HARMonics:AVERage:TCONrol?	410
[:SENSe]:HARMonics:AVERage[:STATe] OFF ON 0 1	409
[:SENSe]:HARMonics:AVERage[:STATe]?	409
[:SENSe]:HARMonics:NUMBer <integer>	410
[:SENSe]:HARMonics:NUMBer?	410
[:SENSe]:HARMonics:RANGe[:LIST]:BWIDth BANDwidth:VIDeo	418
[:SENSe]:HARMonics:RANGe[:LIST]:BWIDth BANDwidth:VIDeo:AUTO OFF ON 0 1	418
[:SENSe]:HARMonics:RANGe[:LIST]:BWIDth BANDwidth:VIDeo:AUTO?	418
[:SENSe]:HARMonics:RANGe[:LIST]:BWIDth BANDwidth:VIDeo?	418
[:SENSe]:HARMonics:RANGe[:LIST]:BWIDth BANDwidth[:RESolution]:AUTO OFF ON 0 1	416
[:SENSe]:HARMonics:RANGe[:LIST]:BWIDth BANDwidth[:RESolution]:AUTO?	416
[:SENSe]:HARMonics:RANGe[:LIST]:BWIDth BANDwidth[:RESolution]<integer>	416
[:SENSe]:HARMonics:RANGe[:LIST]:BWIDth BANDwidth[:RESolution]?	417
[:SENSe]:HARMonics:RANGe[:LIST]:FREQuency <integer>	415
[:SENSe]:HARMonics:RANGe[:LIST]:FREQuency?	415
[:SENSe]:HARMonics:RANGe[:LIST]:SPAN	416
[:SENSe]:HARMonics:RANGe[:LIST]:SPAN?	416
[:SENSe]:HARMonics:RANGe[:LIST]:STATe OFF ON 0 1	415
[:SENSe]:HARMonics:RANGe[:LIST]:STATe?	415
[:SENSe]:HARMonics:RANGe[:LIST]:SWEep:TIME: <integer>	419
[:SENSe]:HARMonics:RANGe[:LIST]:SWEep:TIME:AUTO OFF ON 0 1	419
[:SENSe]:HARMonics:RANGe[:LIST]:SWEep:TIME:AUTO?	419
[:SENSe]:HARMonics:RANGe[:LIST]:SWEep:TIME?	419
[:SENSe]:HARMonics:RTABle:FILL <no query>	419
[:SENSe]:HARMonics:RTABle:STATe OFF ON 0 1	412
[:SENSe]:HARMonics:RTABle:STATe?	412
[:SENSe]:HARMonics:SWEeptime <time>	412
[:SENSe]:HARMonics:SWEeptime:STATe OFF ON 0 1	412

List of Commands

[:SENSe]:HARMonics:SWEeptime:STATe?	412
[:SENSe]:HARMonics:SWEeptime?	412
[:SENSe]:MARKer[1] 2 3 4:X:POSition <param>.....	179
[:SENSe]:MARKer[1] 2 3 4:X:POSition?	179
[:SENSe]:MCPower:AVErAge:COUnT <integer>	429
[:SENSe]:MCPower:AVErAge:COUnT?	429
[:SENSe]:MCPower:AVErAge:TCONrol EXPonential REPeat	430
[:SENSe]:MCPower:AVErAge:TCONrol?	430
[:SENSe]:MCPower:AVErAge[:STATe] OFF ON 0 1	429
[:SENSe]:MCPower:AVErAge[:STATe]?	429
[:SENSe]:MCPower:CARRier:AUTO[:STATe] OFF ON 0 1.....	442
[:SENSe]:MCPower:CARRier:AUTO[:STATe]?	442
[:SENSe]:MCPower:CARRier:COUnT<integer>	431
[:SENSe]:MCPower:CARRier:COUnT?	431
[:SENSe]:MCPower:CARRier:LIST:BANDwidth BWIDth:[INTegration]<Hz>	438
[:SENSe]:MCPower:CARRier:LIST:BANDwidth BWIDth:[INTegration]?	438
[:SENSe]:MCPower:CARRier:LIST:PPResent YES NO	435
[:SENSe]:MCPower:CARRier:LIST:PPResent?	435
[:SENSe]:MCPower:CARRier:LIST:WIDTh <Hz>	437
[:SENSe]:MCPower:CARRier:LIST:WIDTh?	437
[:SENSe]:MCPower:CARRier[:POWer]<dBm>.....	442
[:SENSe]:MCPower:CARRier[:POWer]?	442
[:SENSe]:MCPower:CORRection:NOISe[:AUTO] OFF ON 0 1.....	445
[:SENSe]:MCPower:CORRection:NOISe[:AUTO]?	445
[:SENSe]:MCPower:FILTer[:RRC]:ALPHA <number>	445
[:SENSe]:MCPower:FILTer[:RRC]:ALPHA?	445
[:SENSe]:MCPower:FILTer[:RRC][:STATe] OFF ON 0 1.....	444
[:SENSe]:MCPower:LIMit[:STATe] OFF ON 0 1	444
[:SENSe]:MCPower:LIMit[:STATe]?	444
[:SENSe]:MCPower:METHod IBW RBW	442
[:SENSe]:MCPower:METHod?	442

List of Commands

[:SENSe]:MCPower:OFFSet:LIST:[FREQuency]<Hz>,<Hz>,<Hz>	439
[:SENSe]:MCPower:OFFSet:LIST:[FREQuency]?	439
[:SENSe]:MCPower:OFFSet:LIST:BANDwidth BWIDth:[INTegration]<Hz>,<Hz>,<Hz>	439
[:SENSe]:MCPower:RCARrier:AUTO OFF ON 0 1	431
[:SENSe]:MCPower:RCARrier:AUTO?	431
[:SENSe]:MCPower:RCARrier<integer>	431
[:SENSe]:MCPower:RCARrier?	432
[:SENSe]:MCPower:RCFREquency:AUTO OFF ON 0 1	433
[:SENSe]:MCPower:RCFREquency:AUTO?	433
[:SENSe]:MCPower:RCFREquency<Freq>	433
[:SENSe]:MCPower:RCFREquency?	433
[:SENSe]:OBW:AVERAge:COUNT <integer>	451
[:SENSe]:OBW:AVERAge:COUNT?	451
[:SENSe]:OBW:AVERAge:TCONtrol EXPonential REPeat	452
[:SENSe]:OBW:AVERAge:TCONtrol?	452
[:SENSe]:OBW:AVERAge[:STATe] OFF ON 0 1	451
[:SENSe]:OBW:AVERAge[:STATe]?	451
[:SENSe]:OBW:FREQuency:SPAN <freq>	454
[:SENSe]:OBW:FREQuency:SPAN?	454
[:SENSe]:OBW:MAXHold OFF ON 0 1	452
[:SENSe]:OBW:MAXHold?	452
[:SENSe]:OBW:PERCent <percent>	454
[:SENSe]:OBW:PERCent?	454
[:SENSe]:OBWidth:XDB <dB value>	456
[:SENSe]:OBWidth:XDB?	456
[:SENSe]:POWer[:RF]:ATTenuation <rel_power>	50
[:SENSe]:POWer[:RF]:ATTenuation:AUTO OFF ON 0 1	50
[:SENSe]:POWer[:RF]:ATTenuation:AUTO?	50
[:SENSe]:POWer[:RF]:ATTenuation:STEP[:INCRement] <integer>	68
[:SENSe]:POWer[:RF]:ATTenuation:STEP[:INCRement]?	68
[:SENSe]:POWer[:RF]:ATTenuation?	50

List of Commands

<code>[:SENSe]:POWer[:RF]:GAIN[:STATe] OFF ON 0 1</code>	.59
<code>[:SENSe]:POWer[:RF]:GAIN[:STATe]?</code>	.59
<code>[:SENSe]:POWer[:RF]:MIXer:RANGe[:UPPer] <power></code>	.69
<code>[:SENSe]:POWer[:RF]:MIXer:RANGe[:UPPer]?</code>	.69
<code>[:SENSe]:POWer[:RF]:MMW:PADJust <freq></code>	.55
<code>[:SENSe]:POWer[:RF]:MMW:PADJust?</code>	.56
<code>[:SENSe]:POWer[:RF]:MW:PADJust <freq></code>	.55
<code>[:SENSe]:POWer[:RF]:MW:PADJust?</code>	.55
<code>[:SENSe]:POWer[:RF]:PCENter</code>	.54
<code>[:SENSe]:POWer[:RF]:RANGe:AUTO ONCE</code>	.383
<code>[:SENSe]:PStatistic:BANdwidth BWIDth <freq></code>	.381
<code>[:SENSe]:PStatistic:BANdwidth BWIDth?</code>	.381
<code>[:SENSe]:PStatistic:COUNts <integer></code>	.382
<code>[:SENSe]:PStatistic:COUNts?</code>	.382
<code>[:SENSe]:PStatistic:SWEEp:TIME <time></code>	.383
<code>[:SENSe]:PStatistic:SWEEp:TIME?</code>	.383
<code>[:SENSe]:RADio:STANdard:BANd:CLASs BC0 BC1</code>	.342
<code>[:SENSe]:RADio:STANdard:BANd:CLASs?</code>	.342
<code>[:SENSe]:RADio:STANdard:DEVice BTS MS</code>	.341
<code>[:SENSe]:RADio:STANdard:DEVice?</code>	.341
<code>[:SENSe]:RADio:STANdard:EAMEas</code>	.344
<code>[:SENSe]:RADio:STANdard:EAMEas</code>	.344
<code>[:SENSe]:RADio:STANdard:PACKet DH1 DH3 DH5</code>	.342
<code>[:SENSe]:RADio:STANdard:PACKet?</code>	.342
<code>[:SENSe]:RADio:STANdard:RPARams[:STATe]?</code>	.344
<code>[:SENSe]:RADio:STANdard:RPARams[:STATe]ON Off 1 0</code>	.344
<code>[:SENSe]:RADio:STANdard:SBWidth <freq></code>	.341
<code>[:SENSe]:RADio:STANdard:SBWidth?</code>	.341
<code>[:SENSe]:RADio:STANdard[:SE- Lect]NONE IS95a JSTD IS95C GSM W3GPP C2000MC1 C2000DS C2000MC3 NADC PDC BLUEtooth TETRa WL802DOT11A WL802DOT11B WL802DOT11G HIPERLAN2 DVBT- GPN DVBTIPN</code>	.333

List of Commands

[[:SENSe]:RADio:STANdard[:SELEct]?	333
[[:SENSe]:ROSCillator:EXTernal:FREQUency <value>	268
[[:SENSe]:ROSCillator:EXTernal:FREQUency?	268
[[:SENSe]:ROSCillator:OUTPut[:STATe] OFF ON 0 1	270
[[:SENSe]:ROSCillator:OUTPut[:STATe]?	270
[[:SENSe]:ROSCillator:SOURce INTernal EXTernal	268
[[:SENSe]:ROSCillator:SOURce?	268
[[:SENSe]:SEMAsk:AVERAge:COUNT <integer>	457
[[:SENSe]:SEMAsk:AVERAge:COUNT?	457
[[:SENSe]:SEMAsk:AVERAge[:STATe] OFF ON 0 1	457
[[:SENSe]:SEMAsk:AVERAge[:STATe]?	457
[[:SENSe]:SEMAsk:BANDwidth[n] BWIDth[n]:INTegration <number>	459
[[:SENSe]:SEMAsk:BANDwidth[n] BWIDth[n]:INTegration?	459
[[:SENSe]:SEMAsk:BANDwidth BWIDth[:RESolution] <freq>	460
[[:SENSe]:SEMAsk:BANDwidth BWIDth[:RESolution]:AUTO OFF ON 0 1	460
[[:SENSe]:SEMAsk:BANDwidth BWIDth[:RESolution]:AUTO?	460
[[:SENSe]:SEMAsk:BANDwidth BWIDth[:RESolution]?	460
[[:SENSe]:SEMAsk:CARRier:AUTO[:STATe] OFF ON 0 1	462
[[:SENSe]:SEMAsk:CARRier:AUTO[:STATe]?	462
[[:SENSe]:SEMAsk:CARRier[:POWER] <ampl>	462
[[:SENSe]:SEMAsk:CARRier[:POWER]?	462
[[:SENSe]:SEMAsk:FILTer[:RRC]:ALPHA <number>	476
[[:SENSe]:SEMAsk:FILTer[:RRC]:ALPHA?	476
[[:SENSe]:SEMAsk:FILTer[:RRC][:STATe] OFF ON 0 1	476
[[:SENSe]:SEMAsk:FILTer[:RRC][:STATe]?	476
[[:SENSe]:SEMAsk:FREQUency:SPAN <number>	459
[[:SENSe]:SEMAsk:FREQUency:SPAN?	459
[[:SENSe]:SEMAsk:OFFSet[n]:LIST:BANDwidth BWIDth:IMULti <integer>	468
[[:SENSe]:SEMAsk:OFFSet[n]:LIST:BANDwidth BWIDth:IMULti?	468
[[:SENSe]:SEMAsk:OFFSet[n]:LIST:BANDwidth BWIDth[:RESolution] <freq>...[<freq>] (up to five values)	466

List of Commands

[:SENSe]:SEMAsk:OFFSet[n]:LIST:BANDwidth BWIDth[:RESolution]:AUTO OFF ON 0 1 . . .	466
[:SENSe]:SEMAsk:OFFSet[n]:LIST:BANDwidth BWIDth[:RESolution]:AUTO?	466
[:SENSe]:SEMAsk:OFFSet[n]:LIST:BANDwidth BWIDth[:RESolution]?	466
[:SENSe]:SEMAsk:OFFSet[n]:LIST:FREQuency:STARt <freq>, ... [<freq>]	464
[:SENSe]:SEMAsk:OFFSet[n]:LIST:FREQuency:STARt?	464
[:SENSe]:SEMAsk:OFFSet[n]:LIST:FREQuency:STOP <freq> ... [<freq>]	465
[:SENSe]:SEMAsk:OFFSet[n]:LIST:FREQuency:STOP?	465
[:SENSe]:SEMAsk:OFFSet[n]:LIST:STARt:ABSolute <ampl>,... [<ampl>] (up to five values) . . .	469
[:SENSe]:SEMAsk:OFFSet[n]:LIST:STARt:ABSolute?	469
[:SENSe]:SEMAsk:OFFSet[n]:LIST:STARt:RCARrier <rel_ampl>,... [<rel_ampl>] (up to five values).	471
[:SENSe]:SEMAsk:OFFSet[n]:LIST:STARt:RCARrier?	471
[:SENSe]:SEMAsk:OFFSet[n]:LIST:STATe OFF ON 0 	464
[:SENSe]:SEMAsk:OFFSet[n]:LIST:STATe?	464
[:SENSe]:SEMAsk:OFFSet[n]:LIST:STOP:ABSolute <ampl>,... [<ampl>] (up to five values) . . .	470
[:SENSe]:SEMAsk:OFFSet[n]:LIST:STOP:ABSolute:COUPle OFF ON 0 1	470
[:SENSe]:SEMAsk:OFFSet[n]:LIST:STOP:ABSolute:COUPle?	470
[:SENSe]:SEMAsk:OFFSet[n]:LIST:STOP:ABSolute?	470
[:SENSe]:SEMAsk:OFFSet[n]:LIST:STOP:RCARrier <real number>,[<real number>]....	472
[:SENSe]:SEMAsk:OFFSet[n]:LIST:STOP:RCARrier:COUPle OFF ON 0 1	472
[:SENSe]:SEMAsk:OFFSet[n]:LIST:STOP:RCARrier:COUPle?	472
[:SENSe]:SEMAsk:OFFSet[n]:LIST:STOP:RCARrier?	472
[:SENSe]:SEMAsk:OFFSet[n]:LIST:SWEEptime <time> ... [<time>]	465
[:SENSe]:SEMAsk:OFFSet[n]:LIST:SWEEptime:AUTO OFF ON 0 1	466
[:SENSe]:SEMAsk:OFFSet[n]:LIST:SWEEptime:AUTO?	466
[:SENSe]:SEMAsk:OFFSet[n]:LIST:SWEEptime?	466
[:SENSe]:SEMAsk:OFFSet[n]:LIST:TEST ABSolute AND OR RELative,ABSolute AND OR RELative,ABSolute AND OR RELative,ABSolute AND OR RELative	474
[:SENSe]:SEMAsk:OFFSet[n]:LIST:TEST?	474
[:SENSe]:SEMAsk:SWEEptime <number>	460
[:SENSe]:SEMAsk:SWEEptime:AUTO OFF ON 0 1	460
[:SENSe]:SEMAsk:SWEEptime:AUTO?	460

List of Commands

[[:SENSE]:SEMAsk:SWEEptime?	460
[[:SENSE]:SEMAsk:TYPE TPreF PSDRef.	458
[[:SENSE]:SEMAsk:TYPE?	458
[[:SENSE]:SPURious:AVERage:COUNT <integer>	485
[[:SENSE]:SPURious:AVERage:COUNT?	485
[[:SENSE]:SPURious:AVERage:TCONrol EXPonential REPeat	486
[[:SENSE]:SPURious:AVERage:TCONrol?	486
[[:SENSE]:SPURious:AVERage[:STATe] OFF ON 0 1	485
[[:SENSE]:SPURious:AVERage[:STATe]?	485
[[:SENSE]:SPURious:FSMeas OFF ON 0 1.	499
[[:SENSE]:SPURious:FSMeas?	499
[[:SENSE]:SPURious:POWer[:RF]:LEVel <integer>	499
[[:SENSE]:SPURious:POWer[:RF]:LEVel?	499
[[:SENSE]:SPURious:POWer[:RF]:RANGe:AUTO OFF ON 0 1.	499
[[:SENSE]:SPURious:POWer[:RF]:RANGe:AUTO?	499
[[:SENSE]:SPURious:SPUR.	498
[[:SENSE]:SPURious:SPUR?	498
[[:SENSE]:SPURious:TYPE EXAMine FULL	498
[[:SENSE]:SPURious:TYPE?	498
[[:SENSE]:SPURious[:RANGe][:LIST]:BANDwidth[:RESolution]:AUTO OFF ON 0 1	490
[[:SENSE]:SPURious[:RANGe][:LIST]:BANDwidth[:RESolution]:AUTO?	491
[[:SENSE]:SPURious[:RANGe][:LIST]:BANDwidth[:RESolution]<integer>	490
[[:SENSE]:SPURious[:RANGe][:LIST]:BANDwidth[:RESolution]?	491
[[:SENSE]:SPURious[:RANGe][:LIST]:BWIDth BANDwidth:VIDeo.	491
[[:SENSE]:SPURious[:RANGe][:LIST]:BWIDth BANDwidth:VIDeo:AUTO OFF ON 0 1	491
[[:SENSE]:SPURious[:RANGe][:LIST]:BWIDth BANDwidth:VIDeo:AUTO?	491
[[:SENSE]:SPURious[:RANGe][:LIST]:BWIDth BANDwidth:VIDeo?	491
[[:SENSE]:SPURious[:RANGe][:LIST]:FREQuency:STARt <integer>	488
[[:SENSE]:SPURious[:RANGe][:LIST]:FREQuency:STARt?	489
[[:SENSE]:SPURious[:RANGe][:LIST]:FREQuency:STOP <integer>.	490
[[:SENSE]:SPURious[:RANGe][:LIST]:FREQuency:STOP?	490

List of Commands

[:SENSe]:SPURious[:RANGe][:LIST]:PEAK:EXCursion.	496
[:SENSe]:SPURious[:RANGe][:LIST]:PEAK:EXCursion?	496
[:SENSe]:SPURious[:RANGe][:LIST]:PEAK:THREShold	496
[:SENSe]:SPURious[:RANGe][:LIST]:PEAK:THREShold?	497
[:SENSe]:SPURious[:RANGe][:LIST]:STATe OFF ON 0 1	488
[:SENSe]:SPURious[:RANGe][:LIST]:STATe?	488
[:SENSe]:SPURious[:RANGe][:LIST]:SWEep:TIME: <time>, <time>, ... (up to 20 sweeptimes)	492
[:SENSe]:SPURious[:RANGe][:LIST]:SWEep:TIME:AUTO OFF ON 0 1, OFF ON 0 1	492
[:SENSe]:SPURious[:RANGe][:LIST]:SWEep:TIME:AUTO?	492
[:SENSe]:SPURious[:RANGe][:LIST]:SWEep:TIME?	492
[:SENSe]:SWEep:FFT:SPAN:RATio <integer>	76
[:SENSe]:SWEep:FFT:SPAN:RATio?	76
[:SENSe]:SWEep:POINts <number of points>	245
[:SENSe]:SWEep:POINts?	245
[:SENSe]:SWEep:TIME <time>	242
[:SENSe]:SWEep:TIME:AUTO OFF ON 0 1	242
[:SENSe]:SWEep:TIME:AUTO:RULEs NORMAl ACCuracy	243
[:SENSe]:SWEep:TIME:AUTO:RULEs?	243
[:SENSe]:SWEep:TIME:AUTO?	242
[:SENSe]:SWEep:TIME?	242
[:SENSe]:SWEep:TYPE AUTO FFT SWEep	72
[:SENSe]:SWEep:TYPE:AUTO:RULEs SPEEd DRANge	73
[:SENSe]:SWEep:TYPE:AUTO:RULEs?	73
[:SENSe]:SWEep:TYPE?	72
[:SENSe]:TOIN:AVERAge:COUNt <integer>	423
[:SENSe]:TOIN:AVERAge:COUNt?	423
[:SENSe]:TOIN:AVERAge:TCONrol EXPONential REPEat	425
[:SENSe]:TOIN:AVERAge:TCONrol?	425
[:SENSe]:TOIN:AVERAge[:STATe] OFF ON 0 1	423
[:SENSe]:TOIN:AVERAge[:STATe]?	423
[:SENSe]:TOIN:FREQUency:MIXer:RANGe:AUTO OFF ON 0 1	426

[:SENSe]:TOIN:FREQuency:MIXer:RANGe:AUTO?	426
[:SENSe]:TOIN:FREQuency:MIXer:RANGe[:UPPer] <number>	426
[:SENSe]:TOIN:FREQuency:MIXer:RANGe[:UPPer]?	426
[:SENSe]:TOIN:FREQuency:SPAN <number>	425
[:SENSe]:TOIN:FREQuency:SPAN?	425

1 Using This Document

This book provides you with descriptions and programming information for your analyzer.

Book Organization

There are many terms used throughout this book, for example “active function block,” that are explained in detail in the Getting Started guide. It is recommended that you read the Getting Started guide first.

NOTE	The front- and rear-panel features, along with the numeric keypad and alpha-numeric softkey fundamentals are illustrated and described, in your Getting Started guide.
-------------	--

What is in This Book

- **Book Organization** - describes the organization of this book.
- **Instrument Functions** - provides information about the front-panel and lower-level key functions of your analyzer and their associated programming commands. This information is organized alphabetically by the front-panel key name. For your convenience, the instrument functions information has been divided into three separate chapters; *Instrument Functions: A-L*, *Instrument Functions: M-O*, and *Instrument Functions: P - Z*.
- **Programming Fundamentals** - provides information on SCPI and C programming language basics, and on using GPIB and LAN.
- **Using the STATus System** - provides information about the instruments internal status monitoring system with information on how to monitor the status using a remote program and descriptions of all the available commands.
- **Menu Maps** - illustrates the menu structure of the front-panel and lower-level keys. Refer to this chapter to identify the lower-level softkeys associated with the front-panel keys.

Terms Used in This Book

The following terms are used to describe each key. Note that a key description may not use all the terms.

State Saved: Indicates what happens to a particular function when the instrument state is saved (either to floppy disk or the internal c:\ drive). It also indicates whether the current settings of the function are maintained if the instrument is powered on or preset using **Power On Last State** or **User Preset**.

Dependencies/

Couplings: Describes dependencies or interactions to other functions or settings in the analyzer.

Factory Preset: Describes the function settings after a **Factory Preset**.

Default

Terminator: Indicates the units that will be attached to the numerical value that you have entered. This default will be used from the front panel, when you terminate your entry by pressing the **Enter** key, rather than selecting a units key. This default will be used remotely when you send the command without specifying any units after your value(s).

Range: Describes the range of the smallest to largest values to which the function can be set. If you try to set a value below the minimum value, the analyzer defaults to the minimum value. If you try to set a value above the maximum value, the analyzer defaults to the maximum value.

History: Describes the firmware revision history. *Only applies after first firmware release.*

Remote

Command: Shows the syntax requirements for each SCPI command.

Example: Provides command examples using the indicated remote command syntax.

2 Instrument Functions: A – L

This chapter provides key descriptions and programming information for the front-panel key functions of your analyzer starting with the letters A through L. The front-panel functions are listed alphabetically and are described with their associated menu keys. The lower-level menu keys are arranged and described as they appear in your analyzer.

NOTE The front- and rear-panel features, along with the numeric keypad and alpha-numeric softkey fundamentals are illustrated and described, in your Getting Started guide.

Activates the Reference Level function and displays the Amplitude menu keys. These functions control how data on the vertical (Y) axis is displayed and corrected, and control instrument settings that affect the vertical axis.

2.0.1 Ref Level

Enables you to adjust the absolute amplitude represented by the top graticule line on the display (the reference level). Ref in the upper left corner of the display, indicates the current value. The **Amplitude, Y Axis Units** setting determines the Reference Level units. To change the reference level, use the front-panel step keys, knob, or numeric keypad.

Key Path: **AMPLITUDE / Y Scale**

Dependencies/

Couplings: If you reduce the Attenuation setting, the analyzer may have to lower the Reference Level to maintain the proper level at the top of the screen. If you then increase Attenuation, the Reference Level does *not* increase to its previous value.

When the input attenuator is auto-coupled, **Attenuation (Auto)**, its setting may be affected by changes in the reference level setting. See [“Attenuation” on page 50](#).

Reference level is affected by: Attenuation, Preamp, Ext Amp Gain, Reference level offset, Max Mixer Level, Y-Axis Units.

State Saved: Saved in Instrument State

Factory Preset: 0 dBm

Range: Determined by the settings of the input attenuator, reference level offset, external amplitude gain, and whether the preamp (Option 1DS) is on or off.

Examples:

- 170 dBm to 30 dBm with zero reference level offset
- 180 dBm to 20 dBm with 10 dB ext amp gain
- 160 dBm to 40 dBm with 10 dB reference level offset
- 170 dBm to 0 dBm with preamp on (Option 1DS)

Remote Command:

```
:DISPlay:WINDow[1]:TRACe:Y:[SCALe]:RLEVEL <ampl>
```

```
:DISPlay:WINDow[1]:TRACe:Y:[SCALe]:RLEVEL?
```

Example: DISP:WIND:TRAC:Y:RLEV 20 dbm

Sets the reference level to 20 dBm, which displays in the current Y-Axis Units. For example, if the Y-Axis Units are dB μ V, then 127 dB μ V will be displayed.

2.0.2 Attenuation

Allows you to adjust the input attenuation. Press **Atten Step** to set the attenuation step so that attenuation will change in 2 dB or 10 dB increments. The analyzer input attenuator reduces the power level of the input signal delivered to the input mixer. If set manually, the attenuator is recoupled when **Attenuation (Auto)** is selected. To enter a value below 6 dB, you must use the front-panel numeric keypad.

Attenuation is coupled to Reference Level, so adjusting the Reference Level may change the Attenuation. The analyzer selects an Attenuation setting that is as small as possible while keeping the Ref Level at or below the Max Mixer Lvl setting. The current value is indicated by **Atten** at the top of the display. A # appears in front of **Atten** when **Attenuation (Man)** is selected.

CAUTION To prevent damage to the input mixer, do not exceed a power level of +30 dBm at the input.

To prevent signal compression, keep the power at the input mixer below 0 dBm (10 MHz - 200 MHz), below 3 dBm (200 MHz - 6.6 GHz), and below -2 dBm (6.6 GHz - 50.0 GHz). With the attenuator set to Auto, a signal at or below the reference level results in a mixer level at or below -10 dBm.

Key Path: **AMPLITUDE / Y Scale**

State Saved: Saved in Instrument State

Factory Preset: Auto Coupled, 10 dB (for external amplifier gain of 0 dB)

Resolution/Rounding/

Truncation: The attenuation is resolved to 2 dB increments. Value setting a logarithm: if value is at least 0.5 dB over a value, then the next higher value is selected. Therefore, 10.4 selects 10, while 10.5 selects 12.

Range: 0 dB to 70 dB

Remote Command:

```
[ :SENSe ] :POWer [ :RF ] :ATTenuation <rel_power>
```

```
[ :SENSe ] :POWer [ :RF ] :ATTenuation?
```

```
[ :SENSe ] :POWer [ :RF ] :ATTenuation:AUTO OFF | ON | 0 | 1
```

```
[ :SENSe ] :POWer [ :RF ] :ATTenuation:AUTO?
```

Remote Command Notes: The Reference Level setting may be affected when the Attenuation is changed. See **Ref Level**.

Example: POW:ATT 30

```
POW:ATT?
```

```
POW:ATT:AUTO ON
```

POW:ATT:AUTO?

2.0.3 Scale/Div

Sets the units per vertical graticule division on the display. This function is only available when **Scale Type (Log)** is selected and the vertical scale is power, or **Demod View** is on and the vertical scale is hertz. When **Scale Type (Lin)** is selected, **Scale/Div** is greyed out.

Key Path: **AMPLITUDE / Y Scale**

State Saved: Saved in Instrument State

Factory Preset: 10 dB, in logarithmic scale type

Fundamental

Units: dB; kHz

Terminators: dB; Hz, kHz, MHz, GHz

Default

Terminator: dB; kHz

Range: 0.1 dB to 20 dB

1 kHz to 240 kHz (When **Demod View (On)** is selected.)

Remote Command:

```
:DISPlay:WINDow[1]:TRACe:Y:[SCALE]:PDIVision <power>
```

```
:DISPlay:WINDow[1]:TRACe:Y:[SCALE]:PDIVision?
```

Example: DISP:WIND:TRAC:Y:PDIV 5 DB

2.0.4 Scale Type

Allows you to choose a linear or logarithmic vertical scale for the display and for remote data readout.

The scale type for display and remote data readout may be different from the scale used for averaging processes. For information on the scale used for averaging process, “[Avg/VBW Type](#)” on page 89.

When **Scale Type (Log)** is selected, the vertical graticule divisions are scaled in logarithmic units. The top line of the graticule is the Reference Level and use the scaling per division, **Scale/Div** to assign values to the other locations on the graticule.

When **Scale Type (Lin)** is selected, the vertical graticule divisions are linearly scaled with the reference level value at the top of the display and zero volts at the bottom. Each vertical division of the graticule represents one-tenth of the Reference Level.

The Y Axis Units used for each type of display are set by pressing **Y Axis Units**. The analyzer remembers the settings for both Log and Lin.

Key Path: **AMPLITUDE / Y Scale**

State Saved: Saved in Instrument State

Factory Preset: Log

Remote Command:

```
:DISPlay:WINDow[1]:TRACe:Y:[SCALe]:SPACing LINear|LOGarithmic
```

```
:DISPlay:WINDow[1]:TRACe:Y:[SCALe]:SPACing?
```

Example: DISP:WIND:TRAC:Y:SPAC LOG

 DISP:WIND:TRAC:Y:SPAC?

2.0.5 Presel Center

Adjusts the centering of the preselector filter to optimize the amplitude accuracy at the active marker frequency. If no marker is on when **Presel Center** is pressed, the analyzer turns on the currently selected marker and places it on the peak signal. If a marker is already enabled, it must be placed at the signal peak before activating this function. **Presel Center** only functions when measuring signals ≥ 2.85 GHz in band 1 and higher bands. (The instrument is in band 1, or higher, when the stop frequency is >3 GHz.)

NOTE If the signal is noise-like, the algorithm will not function properly.

For analyzers with a frequency range greater than 26.5 GHz, there are two preselectors (microwave band and millimeter bands). To create an adjustment value for both, the user must setup and request a **Presel Center** in a microwave band, then set up and request a **Presel Center** in a millimeter band.

With **Input Mixer (Ext)** selected and the Mixer Type set to Presel (preselected), **Presel Center** adjusts the frequency of the external preselector filter to maximize the amplitude at the active marker frequency.

Key Path: AMPLITUDE / Y Scale

Remote Command:

```
[ :SENSe ] :POWer [ :RF ] :PCENter
```

Remote Command Notes: This command has no effect if it is invoked in a non-preselected band, or the active marker is less than 3 GHz.

Example: POW:PCEN

2.0.6 Presel Adjust

Allows you to manually adjust the preselector filter frequency to optimize its response on the signal of interest. This function is only available when measuring signals ≥ 2.85 GHz in band 1 and higher bands.

For analyzers that have both millimeter wave and microwave types of bands (E4448A and E4446A analyzers) the adjustment is band specific. If the currently active marker, or the center frequency, is in one of the four lower bands (bands 1 to 4) the preselector adjustment specified is used for the microwave bands. However, if the active marker or center frequency is in one of the two upper bands (bands 5 to 6), then the preselector adjustment is applied for those millimeter bands.

NOTE In the 26.4 to 26.8 GHz range there is an overlap between bands 4 and 5 that causes the boundary between these two bands to shift dynamically. You must be aware that the preselector adjustment is applied to the correct band (either 4 or 5) based on the current settings of the analyzer.

When the preselector adjustment is being changed, the active function area of the display shows a third line (mm-wave bands preselector, or MW bands preselector) dependent on the preselector applied. The preselector applied is determined by the analyzer settings of the start, stop, and marker frequency settings as shown below. Note that applied preselector will be notated in the active function block of the display.

PSA Frequency Setting	Preselector Applied
Start: >26.8 GHz	Millimeter
Stop: <26.8 GHz	Microwave
Start: >26.4 GHz	Millimeter
Start: <26.4 GHz Marker: <26.8 GHz	Microwave
Start: <26.4 GHz Marker: >26.8 GHz	Millimeter

Key Path: **AMPLITUDE / Y Scale**

State Saved: Saved in Instrument State

Factory Preset: 0 Hz

Range: -250 MHz to 250 MHz

Remote Command:

```
[ :SENSe ] : POWER [ :RF ] : MW : PADJust <freq>
```

```
[ :SENSe ] : POWER [ :RF ] : MW : PADJust?
```

```
[ :SENSe ] : POWER [ :RF ] : MMW : PADJust <freq>
```

[:SENSe] :POWer [:RF] :MMW:PADJust?

Example: POW:MW:PADJ 100
 POW:MW:PADJ?

2.0.7 Y Axis Units

Displays the menu keys that enable you to change the vertical (Y) axis amplitude units. The analyzer retains the entered **Y Axis Units** separately for both Log and Lin amplitude scale types. For example, if **Scale Type** has been set to **Log**, and you set **Y Axis Units** to **dBm**, pressing **Scale Type (Log)** sets the **Y Axis Units** to **dBm**. If **Scale Type** has been set to Lin and you set **Y Axis Units** to **Volts**, pressing **Scale Type (Lin)** sets the **Y Axis Units** to **Volts**. Pressing **Scale Type (Log)** again sets the Y Axis units back to dBm.

This key is unavailable (greyed out) when the FM Demod View is on.

Y Axis Units, in conjunction with the **Scale Type**, affect how the data is read off the display, markers, and over the remote interface. When using the remote interface no units are returned, so you must know what the Y-Axis units are to interpret the results:

Key Path: **AMPLITUDE / Y Scale**
State Saved: Saved in Instrument State
Factory Preset: For **Scale Type (Log)** = dBm
 For **Scale Type (Lin)** = Volts

Remote Command:

:UNIT:POWer DBM|DBMV|DBUV|V|W
:UNIT:POWer?

Remote Command Notes: The settings of Y Axis Units and Scale Type, affect how the data is read over the remote interface. When using the remote interface no units are returned, so you must know what the Y-Axis units are to interpret the results:

Example 1, set the following:

Scale Type (Log)
Y Axis Units, dBm
Scale/Div, 1 dB
Ref Level, 10 dBm

This sets the top line to 10 dBm with each vertical division representing 1 dB. Thus, if a point on trace 1 is on the fifth graticule line from the top, it represents 5 dBm and will read out remotely as 5.

Example 2, set the following:

Scale Type (Lin)
Y Axis Units, Volts
Ref Level, 100 mV (10 mV/div)

This sets the top line to 100 mV and the bottom line to 0 V, so each vertical division represents 10 mV. Thus, if a point on trace 1 is on the fifth graticule line from the top, it represents 50 mV and will read out remotely as 50.

Example: UNIT:POW dBmV
 UNIT:POW?

2.0.7.1 dBm

Sets the amplitude units to dBm.

Key Path: AMPLITUDE / Y Scale, More, Y Axis Units

Remote Command:

See [“Y Axis Units” on page 56](#).

Example: UNIT:POW DBM

2.0.7.2 dBmV

Sets the amplitude units to dBmV.

Key Path: AMPLITUDE / Y Scale, More, Y Axis Units

Remote Command:

See [“Y Axis Units” on page 56](#).

Example: UNIT:POW DBMV

2.0.7.3 dB μ V

Sets the amplitude units to dB μ V.

Key Path: AMPLITUDE / Y Scale, More, Y Axis Units

Remote Command:

See [“Y Axis Units” on page 56](#).

Example: UNIT:POW DBUV

2.0.7.4 Volts

Sets the amplitude units to volts.

Key Path: AMPLITUDE / Y Scale, More, Y Axis Units

Remote Command:

See “Y Axis Units” on page 56.

Example: UNIT:POW V

2.0.7.5 Watts

Sets the amplitude units to watts.

Key Path: AMPLITUDE / Y Scale, More, Y Axis Units

Remote Command:

See “Y Axis Units” on page 56.

Example: UNIT:POW W

2.0.8 Ref Lvl Offset

Allows you to add an offset value to the displayed reference level. The reference level is the absolute amplitude represented by the top graticule line on the display. Reference-level offsets are entered by using the numeric keypad or programming commands. The knob and step keys are not active.

Offsets are used when gain or loss occurs between a device under test and the analyzer input. Thus, the signal level measured by the analyzer may be thought of as the level at the input of an external amplitude conversion device. Entering an offset does not affect the trace position or attenuation value, just the displayed value readouts such as reference level and marker amplitudes.

The maximum reference level available is dependent on the reference level offset. That is, Ref Level – Ref Level Offset must be in the range –170 to +30 dBm.

For example, the reference level value range can be initially set to values from –170 dBm to 30 dBm with no reference level offset. If the reference level is first set to –20 dBm, then the reference level offset can be set to values of –50 to +150 dB.

If the reference level offset is first set to –30 dB, then the reference level can be set to values of –200 dBm to 0 dBm. In this case, the reference level is “clamped” at 0 dBm because the maximum limit of +30 dBm is reached with a reference level setting of 0 dBm with an offset of –30 dB. If instead, the reference level offset is first set to 30 dB, then the reference level can be set to values of –140 to +60 dBm.

When a reference level offset is entered, the offset value appears on the left side of the display under *Offset* (as opposed to frequency offsets which appear at the bottom of the display.) To eliminate an offset, press **Ref Lvl Offset, 0, and dB**.

Key Path: **AMPLITUDE / Y Scale**

Key Notes: Only numeric entries are valid, the knob and step keys are not applicable to this function.

Annunciation/

Annotation: The offset is displayed to left of Trace window; third from the top, just below the scale type.

State Saved: Saved in Instrument State

Factory Preset: 0.0 dB

Range: -327.6 dB to 327.6 dB

Remote Command:

`:DISPlay:WINDow [1] :TRACe:Y: [SCALe] :RLEVel:OFFSet <rel_power> (in dB)`

`:DISPlay:WINDow [1] :TRACe:Y: [SCALe] :RLEVel:OFFSet?`

Example: `DISP:WIND:TRAC:Y:RLEV:OFFS 12.7` Sets the Ref Level Offset to 12.7 dB. The only valid suffix is dB. If no suffix is sent, dB will be assumed.

2.0.9 Int Preamp

(Option 1DS only.) Turns the internal preamp on and off. The preamp functions over a frequency range of 100 kHz to 3 GHz. When the preamp is on, an automatic adjustment compensates for the gain of the preamp so that displayed amplitude readings still accurately reflect the value at the analyzer input connector. The preamp is switched off for frequencies above 3 GHz, and the correction is not applied, even though the PA annotation remains on screen. For signal frequencies below 100 kHz, the preamp is not automatically switched out, but signal amplitude roll-off occurs even in the “DC” setting of the RF Coupling control.

The gain of the preamp is nominally 30 dB (PSA) or 20 dB (ESA).

Key Path: **AMPLITUDE / Y Scale**

Dependencies/

Couplings: Reference level, Attenuation

State Saved: Saved in Instrument State

Factory Preset: Off

Remote Command:

`[:SENSe] :POWer [:RF] :GAIN [:STATe] OFF | ON | 0 | 1`

`[:SENSe] :POWer [:RF] :GAIN [:STATe] ?`

Example: `POW:GAIN 1`

`POW:GAIN?`

2.0.10 Corrections

Accesses the **Corrections** menu keys that allow you to enable the corrections function and to

select which set of correction factors you wish to modify. These frequency/amplitude corrections will be applied to the displayed data to correct for system losses/gains outside the analyzer. Four different sets of correction data can be stored.

Key Path: **AMPLITUDE / Y Scale, More**

Remote Command:

There is no equivalent remote command for this key.

2.0.10.1 Apply Corrections

Pressing **Apply Corrections** (Yes) turns on the amplitude-correction factors. Corrections will only be applied for the sets of correction factors whose correction state is set to On. To turn a set of correction factors on, use the **Correction On Off** key in the Antenna, Cable, Other, or User menus.

Key Path: **AMPLITUDE / Y Scale, More, Corrections**

Annunciation/

Annotation: When **Apply Corrections** (Yes) is selected, an A will appear in the screen annotation on the left edge of the display, whether or not a correction set has been turned on using the **Correction** (On) key in the Antenna, Cable, Other, or User menus.

State Saved: Saved in Instrument State

Factory Preset: No

Remote Command:

```
[ :SENSe] :CORRection:CSET:ALL [:STATe] OFF|ON|0|1
```

```
[ :SENSe] :CORRection:CSET:ALL [:STATe] ?
```

Remote Command Notes: To turn On or Off an individual correction set, use:

```
[ :SENSe] :CORRection:CSET [1] | 2 | 3 | 4 [:STATe]
```

Example: CORR:CSET:ALL ON

```
CORR:CSET:ALL?
```

2.0.10.2 Antenna, Cable, Other, and User Keys

Pressing **Antenna**, **Cable**, **Other**, or **User** accesses the Correction menu for that type of correction data. These 4 keys display the status of correction sets. If the key indicates **On**, then amplitude corrections for this type have been enabled. To perform the corrections, both this key and **Apply Corrections** must indicate **Yes**. The status is toggled in the correction set menu located under **Correction**.

Key Path: **AMPLITUDE / Y Scale, More, Corrections**

Remote Command:

There is no remote command for this key.

2.0.10.2.1 Correction

Turns the amplitude correction function on or off for the specific set of correction data. The corrections state must be set to **On** for the correction to be applied.

NOTE **Antenna, Cable, and Other** correction factors are generally entered as positive values. This indicates a loss in the external device. **User** correction factors are typically entered as negative values which indicate a gain in the external device.

Key Path: **AMPLITUDE / Y Scale, More, Corrections, Antenna (Cable, Other, or User)**

State Saved: Saved in Instrument State

Factory Preset: No

Remote Command:

```
[ :SENSE ] :CORRection:CSET [ 1 ] | 2 | 3 | 4 [ :STATe ] OFF | ON | 0 | 1
```

```
[ :SENSE ] :CORRection:CSET [ 1 ] | 2 | 3 | 4 [ :STATe ] ?
```

Remote Command Notes: [:SENSE] :CORRection:CSET:ALL [:STATe] must be set to on for this command to function.

CSET number equivalents to front-panel access definitions are as follows:

CSET or CSET1 is Antenna
CSET2 is Cable
CSET3 is Other
CSET4 is User

Example: CORR:CSET2 ON

 CORR:CSET2?

2.0.10.2.2 Edit

Accesses menu keys that allow you to create and edit an amplitude-correction factor set. It puts the analyzer into a split-screen mode where the correction data is displayed in a table under the trace data. Pressing **ESC** while in this menu will exit the menu and remove the table from the screen. New points will be applied only after the editor is closed.

Key Path: **AMPLITUDE / Y Scale, More, Corrections, Antenna (Cable, Other, or User)**

Remote Command:

```
[ :SENSE ] :CORRection:CSET [ 1 ] | 2 | 3 | 4 :DATA  
<freq>, <rel_amp1> { , <freq>, <rel_amp1> } Creates an amplitude-correction factor set
```

```
[ :SENSE ] :CORRection:CSET [ 1 ] | 2 | 3 | 4 :DATA:MERGe  
<freq>, <rel_amp1> { , <freq>, <rel_amp1> } Adds the points with the specified values to  
the current amplitude correction data, allowing you to merge correction data. If too much
```

data is merged, as many points as possible are merged into the existing data and then an error is reported.

```
[ :SENSe] :CORRection:CSET [1] | 2 | 3 | 4:DATA?
```

Remote Command Notes: [:SENSE]:CORREction:CSET:ALL[:STATE] must be set to on for this command to function.

CSET number equivalents to front-panel access definitions are as follows:

CSET or CSET1 is Antenna
CSET2 is Cable
CSET3 is Other
CSET4 is User

- <freq> is the frequency (in Hz) where the correction should be applied; no unit is allowed in this parameter
- <rel_amp1> is the amount of relative amplitude correction (in dB) needed; no unit is allowed in this parameter

Example: :CORR:CSET2:DATA 900E6,0.3,1.0E9,0.35,1.3E9,0.2

2.0.10.2.2.1 Point

Allows you to create or edit an amplitude-correction factor data point. Up to 200 points may be defined for each set. Enter the point number to be created or edited by using the numeric keypad, then press **Enter**, or use the knob or step keys to move to an existing point. After selecting a point, **Frequency** becomes active.

Key Path: **AMPLITUDE / Y Scale, More, Corrections, Antenna (Cable, Other, or User), Edit**

State Saved: Not part of instrument state, saved in a corrections file.

Remote Command:

See [“Edit” on page 62](#)

2.0.10.2.2.2 Frequency

Allows you to enter the frequency value for an amplitude-correction point. Enter the frequency value by using the numeric keypad. Change the frequency value by using the step keys or the knob. After entering a frequency, **Amplitude** becomes active.

A frequency coordinate must always be specified for amplitude-correction factors. Amplitude-correction data is sorted in the table by frequency. The sorting occurs immediately after you have entered the frequency value via the front-panel.

NOTE The amplitude correction entered for the lowest frequency will be applied to all frequencies less than the lowest frequency entered. Similarly, the amplitude correction for the highest frequency entered will be applied to all frequencies greater than the highest frequency entered.

Key Path: **AMPLITUDE / Y Scale, More, Corrections, Antenna (Cable, Other, or User), Edit**

State Saved: Not part of instrument state, saved in a corrections file.

Remote Command:

See [“Edit” on page 62](#)

2.0.10.2.2.3 Amplitude

Allows you to enter the amplitude value for the current amplitude-correction point. After entering an amplitude, the point number automatically increments and **Frequency** becomes active to allow entry of the frequency of the next point.

Key Path: **AMPLITUDE / Y Scale, More, Corrections, Antenna (Cable, Other, or User), Edit**

State Saved: Not part of instrument state, saved in a corrections file.

Remote Command:

See [“Edit” on page 62](#)

2.0.10.2.2.4 Delete Point

Allows you to delete the amplitude-correction data for the currently selected point. The prompt “If you are sure, press key again to delete” will appear on the display. Pressing **Delete Point** again will delete the point and adjust all of the point numbers as appropriate.

Key Path: **AMPLITUDE / Y Scale, More, Corrections, Antenna (Cable, Other, or User), Edit**

Remote Command:

See [“Edit” on page 62](#)

2.0.10.2.3 Delete Corrections

Allows you to clear all data from the selected amplitude-correction set. The prompt If you are sure, press key again to delete will appear on the display. Pressing **Delete** again will delete the correction set.

Key Path: **AMPLITUDE / Y Scale, More, Corrections, Antenna (Cable, Other, or User)**

Remote Command:

```
[ :SENSE ] :CORRection:CSET [ 1 | 2 | 3 | 4 :DELete
```

Remote Command Notes: CSET number equivalents to front-panel access definitions are as follows:

CSET or CSET1 is Antenna
CSET2 is Cable
CSET3 is Other
CSET4 is User

Example: CORR:CSET4:DEL

2.0.10.3 Freq Interp

Allows you to determine how trace values are computed between points in a correction table. If the linear mode is selected, a straight line is used between points in the correction table (for a linear frequency scale and for a decibel amplitude scale). If the logarithmic mode is selected, frequency values between points are computed by first taking the logarithm of both table values and the intermediate value, while using decibel amplitude values.

Key Path: **AMPLITUDE / Y Scale, More, Corrections**

State Saved: Not saved in instrument state

Factory Preset: Not affected by Factory Preset. Will be set to linear by Restore Factory Defaults.

Remote Command:

```
[ :SENSe ] :CORRection:CSET [ 1 ] | 2 | 3 | 4 :X:SPACing LINear | LOGarithmic
```

Example: CORR:CSET4:X:SPAC LOG

2.0.10.4 Delete All Corrections

Allows you to delete all amplitude-correction sets.

Key Path: **AMPLITUDE / Y Scale, More, Corrections**

Dependencies/

Couplings: If corrections are on, corrections are turned off.

Remote Command:

```
[ :SENSe ] :CORRection:CSET:ALL:DELeTe
```

Example: CORR:CSET:ALL:DEL

2.0.11 Ext Amp Gain

Compensates for external gain/loss. The function is similar to the Ref Lvl Offset function, however the value is considered, along with the maximum mixer level setting, to determine the attenuation required (10 dB of Attenuation is added for every 10 dB of External Amp Gain). The gain is subtracted from the amplitude readout so that the displayed signal level represents the signal level at the input of the external device.

Gains may only be entered with the numeric keypad or programming commands, not the knob or step keys.

Key Path: **AMPLITUDE / Y Scale**

State Saved: Saved in Instrument State, and survives Preset and power cycle

Factory
Default: 0 dB

NOTE Ext Amp Gain is not affected by Factory Preset or power cycle. It can be reset to the factory default by pressing **System, Restore Sys Defaults**.

Range: -81.90 dB to 81.90 dB

Remote Command:

```
[ :SENSE ] :CORRection:OFFSet [ :MAGNitude ] <relative_power> (in dB)
```

```
[ :SENSE ] :CORRection:OFFSet [ :MAGNitude ] ?
```

Example: CORR:OFFS:MAGN 7.3 DB

Sets the Ext Amp Gain to 7.3 dB. The only valid suffix is dB. If no suffix is sent, dB is assumed.

2.0.12 Atten Step

Permits the selection of 2 dB (for PSA), 5 dB (for ESA), or 10 dB (for PSA/ESA) step resolution for input attenuation.

Key Path: **AMPLITUDE / Y Scale**

Saved State: Saved in instrument state

Factory Preset: 2 dB, for PSA; 5 dB, for ESA

Remote Command:

```
[ :SENSE ] :POWEr [ :RF ] :ATTenuation:STEP [ :INCRement ] <integer> (in dB)
```

```
[ :SENSE ] :POWEr [ :RF ] :ATTenuation:STEP [ :INCRement ] ?
```

Example: POW:ATT:STEP 10

Sets the Attenuation to 10 dB. The only valid suffix is dB. If no suffix is sent, dB is assumed.

If a value >5 is entered, 10 is used.

If a value ≤5 is entered, 2 is used for PSA, or 5 is used for ESA.

2.0.13 Max Mixer Lvl

Enables you to set the relationship between the highest signal that can be displayed (the reference level) and the input attenuation. The relationship applies whenever the **Attenuation** is set to **Auto**. The relationship is that the attenuation is given by reference level minus the max mixer level. For example, as the reference level changes, the input attenuator changes to ensure that a signal at the reference level does not exceed the **Max Mixer Lvl** setting.

Key Path: **AMPLITUDE / Y Scale**

State Saved: Saved in Instrument State

Factory Preset: -10 dBm

Range: -50 dBm to -10 dBm

Remote Command:

```
[ :SENSe ] : POWER [ :RF ] : MIXer : RANGe [ :UPPer ] <power>
```

```
[ :SENSe ] : POWER [ :RF ] : MIXer : RANGe [ :UPPer ] ?
```

Example: POW:MIX:RANG -15 dBm

2.1 Auto Couple

Coupled functions are functions that are linked/dependent on other functions. Pressing **Auto Couple** displays some of the most important coupled analyzer functions.

An example of a coupled function is Res BW (resolution bandwidth). When Res BW is set to auto, the Res BW is automatically set based on the span setting.

Coupled functions are affected depending on how they are coupled. For example, Video BW is *coupled to* Res BW, so changing Res BW affects Video BW, but changing Video BW does not affect Res BW. Changing Video BW puts it in manual (instead of auto-coupled). When Video BW is set to **Man** it is unaffected by Res BW changes.

When a function is in the **Man** state, a # will appear next to its annotation on the display. If one or more functions are manually set so that the amplitude or frequency measurement becomes uncalibrated, “Meas Uncal” appears on the top right side of the graticule.

2.1.1 Auto All

Auto-couples all coupled functions. If **Auto All** is pressed all coupled functions are set to **Auto**. Setting any auto coupled function to **Man** (manual), uncouples that function without changing the coupling of other functions.

Coupled functions are functions that are linked. When **Auto All** is pressed, the analyzer automatically couples all instrument settings that have auto/man choices. In most cases, these auto settings give the most accurate measurements and optimum dynamic range. When a function is coupled, it is in the **Auto** state. When it is uncoupled it is in the **Man** state.

Key Path: **Auto Couple**

Dependencies/

Couplings: When segmented sweep is on, this key is not available (greyed out).

When **Auto All** is selected:

- **Resolution BW** couples to: **Span** and **Span/RBW**
- **Video BW** couples to: **Res BW** and **VBW/RBW**
- **Sweep Time** couples to: **Res BW**; **Video BW**; **Detector**; **Span** and **Center Frequency**
- **CF Step** couples to: **Span** in swept spans, to **Res BW** in zero span
- **Attenuation** couples to: **Ref Level**; **Ext Amp Gain**; **Atten Step**; **Max Mixer Lvl**; and **Int Preamp**
- **FFT & Sweep** couples to: **Res BW** and **Span**
- **PhNoise Opt** (phase noise optimization) couples to: **Res BW**; **Span** and **FFT & Sweep** sweep type
- **Detector** couples to: marker functions; **Avg/VBW Type**; **Average On Off**; **Max Hold** and **Min Hold**
- **Average Type** couples to: the marker functions; **Detector** and **Scale Type**
- **ADC Dither** couples to: **Sweep Type**; **Span**; **Res BW**; **ADC Ranging** and **FFTs/Span**

- **VBW/RBW** ratio is set to 1.0
- **Span/RBW** ratio is set to Auto
- **Auto Sweep Time** is set to Normal
- **FFT & Sweep** is set to Auto: Best Dynamic Range
- **ADC Ranging** is set to Autorange
- **Marker Count, Gate Time** is set to Auto

NOTE Marker Trace and Printer have an **Auto** setting, but are not affected by **Auto All**.

Remote Command:

:COUPlE ALL|NONE

:COUPlE?

Remote Command Notes: sets all the functions to the manual (not coupled) mode. There is no front-panel key equivalent to the COUPlE NONE command.

ALL puts all the functions into the auto coupled mode.

Example: COUP ALL

2.1.2 FFT & Sweep

Selects the FFT vs. Sweep key functions.

Key Path: Auto Couple

Remote Command:

[:SENSE] :SWEep:TYPE AUTO|FFT|SWEep changes the sweep type to FFT or swept, or it lets the analyzer automatically choose the type of analysis to use based on current instrument settings.

[:SENSE] :SWEep:TYPE?

Example: SWE:TYPE FFT

2.1.2.1 Auto: Best Dynamic Range

This function is automatically activated when **Auto All** is selected. Selecting **Auto: Best Dynamic Range** tells the analyzer to choose between swept and FFT analysis, with a primary goal of optimizing dynamic range. If the dynamic range is very close between swept and FFT, then it chooses the faster one.

While **Zero Span** is selected, this key is greyed out. The status of the FFT & Swept selection is saved when entering zero span and is restored when leaving zero span.

Key Path: Auto Couple, FFT & Sweep

Saved State: Saved in instrument state

Remote Command:

[:SENSE] :SWEep:TYPE:AUTO:RULEs SPEed|DRANge selects the rules to use when SWE:TYPE AUTO is selected. This setting, combined with your current analyzer setup, is used to select either FFT or swept mode.

[:SENSE] :SWEep:TYPE:AUTO:RULEs?

Example: SWEep:TYPE AUTO selects the automatic mode.

SWE:TYPE:AUTO:RUL DRAN sets the rules for the auto mode to dynamic range.

2.1.2.2 Auto: Best Speed

Selecting **Auto: Best Speed** tells the analyzer to choose between FFT or swept analysis based on the fastest analyzer speed. While **Zero Span** is selected, this key is greyed out. The auto-couple settings are kept in memory and are restored whenever leaving **Zero Span**.

Key Path: **Auto Couple, FFT & Sweep**

Saved State: Saved in instrument state

Remote Command:

[:SENSe] :SWEep:TYPE:AUTO:RULEs SPEed|DRANge selects the rules to use when SWE:TYPE AUTO is selected. This setting, combined with your current analyzer setup, is used to select either FFT or swept mode.

See “Auto: Best Dynamic Range” on page 72.

Example: SWEep:TYPE AUTO selects the automatic mode.

SWE:TYPE:AUTO:RUL SPE sets the rules for the auto mode to speed

2.1.2.3 Manual: Swept

Manually selects swept analysis, so it cannot change automatically to FFT.

While **Zero Span** is selected, this key is greyed out. The status of the FFT & Swept selection is saved when entering zero span and is restored when leaving zero span.

Key Path: **Auto Couple, FFT & Sweep**

Saved State: Saved in instrument state

Remote Command:

Use [:SENSe] :SWEep:TYPE AUTO|FFT|SWEep

See “FFT & Sweep” on page 72.

Example: SWE:TYPE SWE

2.1.2.4 Manual: FFT

Manually selects FFT analysis, so it cannot change automatically to swept.

While **Zero Span** is selected, this key is greyed out. The status of the FFT & Swept selection is saved when entering zero span and is restored when leaving zero span.

TIP Making Gated FFT Measurements With Your PSA

The process of making a spectrum measurement with FFTs is inherently a “gated” process, in that the spectrum is computed from a time record of short duration, much like a gate signal in swept-gated analysis.

The duration of the time record is 1.83 divided by the RBW, within a tolerance of about 3% for bandwidths up through 1 MHz. Therefore, unlike swept gated analysis, the duration of the analysis is fixed by the RBW, not by the gate signal. Because FFT analysis is inherently faster than swept analysis, the gated FFT measurements can have better frequency resolution (a narrower RBW) than would swept analysis for a given duration of the signal to be analyzed.

FFT analysis in the PSA usually involves making auto ranged measurements, and the time required to autorange the FFT can be both long and inconsistent. The PSA hardware automatically sets the **ADC Ranging to Bypass** when any trigger, except **Free Run** is selected.

The width of a single FFT measurement can be up to 10 MHz, so gated FFT measurements can only be made for spans of 10 MHz or less.

To make a gated FFT measurement, set the analyzer as follows.

1. Press **Auto Couple, FFT & Sweep** to select **Manual: FFT**.
2. Set the resolution bandwidth to 1.83 divided by the required analysis time, or higher, by pressing **BW/Avg, Res BW**.
3. Set the trigger source to the desired trigger, by pressing **Trig**.
4. Set the trigger delay to observe the signal starting at the required time relative to the trigger. Negative delays are possible, by pressing **Trig, Trig Delay**.

Key Path: **Auto Couple, FFT & Sweep**

Remote Command:

Use [:SENSe]:SWEep:TYPE AUTO|FFT|SWEep

See “FFT & Sweep” on page 72.

Example: SWE:TYPE FFT

2.1.2.5 FFTs/Span

Displays and controls the number of FFT segments used to measure the entire Span. This key is inactive (greyed out) unless **Sweep Type** has been set to FFT. If **Sweep Type** is set to Auto and FFTs are selected, FFTs/Span is still greyed out, and the number of FFTs automatically selected is shown. If **Sweep Type** is set to **Manual:FFT**, **FFTs/Span** becomes available. Press **FFTs/Span** and an integer can be entered. The analyzer will try to use the number entered, but it may need to use more due to hardware or software limitations.

An FFT can only be performed over a limited span or segment (also known as the FFT width). Several FFT widths may need to be combined to measure the entire span. The "FFT Width" is $(\text{Span})/(\text{FFTs/Span})$, and affects the ADC Dither function. (See **Auto Couple**).

FFT measurements require that the signal level driving the A/D converter in the IF be small enough to avoid overloading, and that the gain that controls that signal level remain fixed during the measurement of an entire FFT segment. This constraint can allow higher dynamic ranges in swept mode in some cases, but increasing FFTs/Span can restore that dynamic range to FFT measurements, at the expense of losing some of the speed advantages of the FFT.

For example, in pulsed-RF measurements such as radar, it is often possible to make high dynamic range measurements with signal levels approaching the compression threshold of the analyzer in swept spans (well over 0 dBm), while resolving the spectral components to levels below the maximum IF drive level (about -8 dBm at the input mixer). But FFT processing experiences overloads at the maximum IF drive level even if the RBW is small enough that no single spectral component exceeds the maximum IF drive level. If the user reduces the width of an FFT using the FFTs/Span function, an analog filter is placed before the ADC that is about 1.3 times as wide as the FFT segment width. This spreads out the pulsed RF in time and reduces the maximum signal level seen by the ADC. Therefore, the input attenuation can be reduced and the dynamic range increased without overloading the ADC.

Further improvement in dynamic range is possible by changing the ADC gain. In swept analysis in PSA, the gain is normally auto ranged such that it can track the signal power as the analyzer sweeps through CW-like signals. Since FFT processing cannot autorange the gain within the measurement of a single FFT segment, the autoranging advantage is lost for single FFT measurements. But if the segments are reduced in width by using more FFTs/Span, then individual FFT segments can use higher gains, improving dynamic range.

Additional information about selecting FFTs/Span can be found in a product note, "PSA Series Swept and FFT Analysis," literature number 5980-3081EN, available online through <http://www.agilent.com>.

Key Path: **Auto Couple, FFT & Sweep**
State Saved: Saved in Instrument State
Factory Preset: 1
Range: 1 to 400000

Remote Command:

```
[ :SENSe ] :SWEp:FFT:SPAN:RATio <integer>
```

```
[ :SENSe ] :SWEp:FFT:SPAN:RATio?
```

Example: SWE:FFT:SPAN:RAT 20

2.1.3 PhNoise Opt

Selects the LO (local oscillator) phase noise behavior for various operating conditions. The selected value is displayed below the ϵ (f) indicator on the left side of the screen. It is preceded by # if **PhNoise Opt Auto** has been selected.

Key Path: **Auto Couple**

State Saved: Saved in instrument state

Factory Preset: Auto

Remote Command:

```
[ :SENSe ] :FREQuency:SYNTHeSis 1|2|3
```

- 1, selects optimization of phase noise for frequencies offset <50 kHz from the carrier.
- 2, selects optimization of phase noise for frequencies offset >50 kHz from the carrier.
- 3, selects optimization of LO for fast tuning

```
[ :SENSe ] :FREQuency:SYNTHeSis?
```

```
[ :SENSe ] :FREQuency:SYNTHeSis:AUTO OFF|ON|0|1
```

```
[ :SENSe ] :FREQuency:SYNTHeSis:AUTO?
```

Example: FREQ:SYNT:AUTO OFF

 FREQ:SYNT 3, selects optimization for fast tuning

2.1.3.1 Auto

Selects the LO phase noise behavior to optimize speed or dynamic range for various instrument operating conditions.

For PSA: the **Auto** rules choose **Fast Tuning** whenever the span ≥ 10.5 MHz or the Res BW >200 kHz. Otherwise, for spans >141.4 kHz, and for Res BWs >9.1 kHz, the **Auto** rules choose **Optimize ϵ (f) for f >50 kHz**. All remaining cases choose **Optimize ϵ (f) for f <50 kHz**.

Key Path: **Auto Couple, PhNoise Opt**

Remote Command:

See “PhNoise Opt” on [page 76](#).

Example: FREQ:SYNT:AUTO ON

2.1.3.2 Optimize $\mathcal{L}(f)$ for frequencies < 50 kHz

The LO phase noise is optimized for offsets less than 50 kHz from the carrier, at the expense of phase noise beyond 50 kHz offset.

Key Path: **Auto Couple, PhNoise Opt**

Remote Command:

See “PhNoise Opt” on [page 76](#).

Example: `FREQ:SYNT 1`

2.1.3.3 Optimize $\mathcal{L}(f)$ for frequencies > 50 kHz

Optimizes phase noise for offsets above 50 kHz from the carrier, especially those from 70 kHz to 300 kHz. Closer offsets are compromised and the throughput of measurements (especially remote measurements where the center frequency is changing rapidly), is reduced. There is a graph of typical phase noise performance in the Specifications Guide.

Key Path: **Auto Couple, PhNoise Opt**

Remote Command:

See “PhNoise Opt” on [page 76](#).

Example: `FREQ:SYNT 2`

2.1.3.4 Optimize LO for Fast Tuning

In this mode, the LO behavior compromises phase noise at all offsets from the carrier below approximately 2 MHz. This allows rapid measurement throughput when changing the center frequency or span.

Key Path: **Auto Couple**

Remote Command:

See “PhNoise Opt” on [page 76](#).

Example: `FREQ:SYNT 3`

2.1.4 Detector

See **Detector** in Det/Demod menu.

Key Path: **Auto Couple**

2.1.5 Avg/VBW Type

See **Avg/VBW Type** in the BW/Avg menu.

Key Path: **Auto Couple**

2.1.6 ADC Dither

Access the menu to set **ADC Dither** to **On**, **Off**, or **Auto**.

Key Path: **Auto Couple**

Remote Command:

```
[ :SENSe] :ADC:DITHer [:STATe] OFF|ON|AUTO
```

```
[ :SENSe] :ADC:DITHer [:STATe] ?
```

Example: `:ADC:DITH OFF`

2.1.6.1 Auto

Turns the ADC dither to automatic. It then chooses on or off according to which is most likely to be the best selection, based on the other analyzer settings such as span, resolution BW and sweep type (FFT or swept).

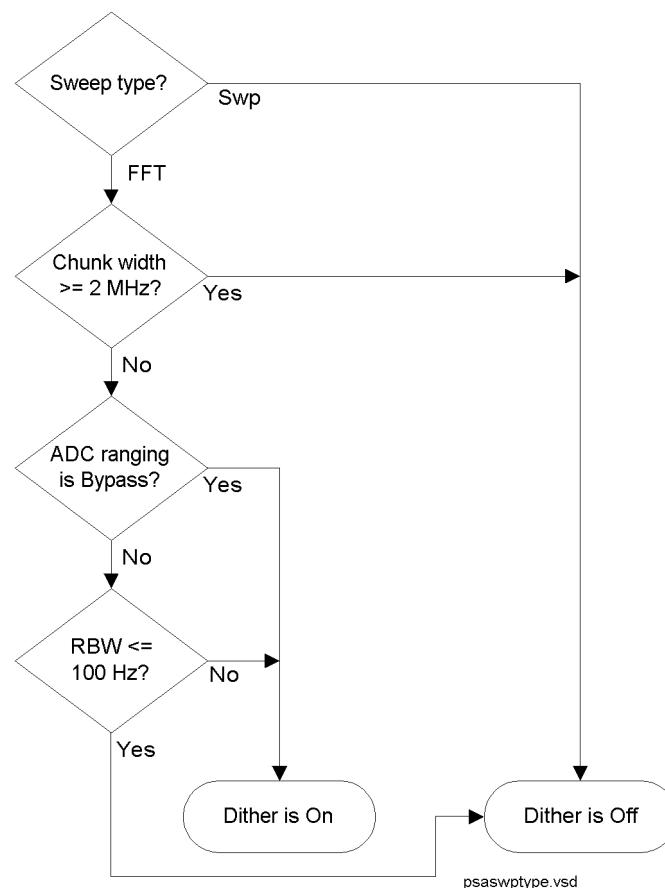

Key Path: **Auto Couple**

State Saved: **Saved in instrument state**

Factory Preset: **Auto**

Remote Command:

Use [:SENSe] :ADC:DITHer [:STATe] AUTO

Example: ADC:DITH AUTO

2.1.6.2 On

When **ADC Dither** is **On**, the linearity of low-level signals is improved. However, the ADC dynamic range is reduced to make room for the dither. As a result, the noise floor of the analyzer is somewhat compromised. So making measurements with ADC dither on gives you better amplitude linearity, but turning ADC dither off gives you a lower noise floor (better sensitivity).

Key Path: **Auto Couple**

State Saved: Saved in instrument state

Remote Command:

[:SENSe] :ADC:DITHer [:STATe] ON

Example: ADC:DITH ON

2.1.6.3 Off

When **ADC Dither** is **Off**, the instrument noise floor is improved. If ADC dither is on the ADC dynamic range is reduced to make room for the dither. As a result, the noise floor of the analyzer is somewhat compromised. So making measurements with ADC dither on gives you improved amplitude linearity. but turning ADC dither off gives you a lower noise floor (better sensitivity).

Key Path: **Auto Couple**

State Saved: Saved in instrument state

Remote Command:

Use [:SENSe] :ADC:DITHer [:STATe] OFF

Example: :ADC:DITH OFF

2.1.7 ADC Ranging

Accesses the keys to set the ADC ranging to provide for the best signal to noise ratio (**Bypass**), or for the best FFT speed (**Autorange**).

Key Path: **Auto Couple**

State Saved: Saved in Instrument State

Factory Preset: Autorange

Remote Command:

```
[ :SENSe] :ADC:RANGe AUTO|NONE
```

```
[ :SENSe] :ADC:RANGe?
```

Example:

```
ADC:RANG NONE
```

2.1.7.1 Autorange

Turns the ADC ranging to automatic which provides the best signal to noise ratio. Auto Couple All sets the ADC ranging to Autorange. Autorange is usually preferred over Bypass.

Key Path: **Auto Couple**

State Saved: Saved in Instrument State

Remote Command:

Example: ADC:RANG AUTO

2.1.7.2 Bypass

Turning the ADC ranging to bypass mode allows higher throughput for FFT measurements. (It can improve FFT measurement speed by 10% to 50%.) Bypass also provides better phase noise, though the effect is negligible when using swept analysis or for offsets below 300 kHz. The $\mathcal{E}(f)$ improvement is a few dB in FFT mode at 800 kHz offset.

Bypass allows triggered FFT measurements to occur at the trigger time instead of following an autoranging time. Therefore, whenever the trigger selected is anything other than **Free Run**, and the **Manual:FFT** sweep selection is made, the ADC hardware is set to Bypass regardless of the setting of ADC Ranging. See [“Making Gated FFT Measurements With Your PSA” on page 74](#). Another advantage of Bypass is lower IF harmonic distortion, which may be visible with very high signal levels at the input mixer.

Key Path: **Auto Couple**

State Saved: Saved in Instrument State

Remote Command:

Example: ADC:RANG NONE

2.2 BW/Avg

Activates the resolution bandwidth function, and displays the menu keys that control both the bandwidth and averaging functions.

2.2.1 Res BW

Enables you to select the 3.01 dB resolution bandwidth (RBW) of the analyzer in 10% steps from 1 Hz to 3 MHz, plus bandwidths of 4, 5, 6, or 8 MHz.

If an unavailable bandwidth is entered with the numeric keypad, the closest available bandwidth is selected.

Sweep time is coupled to RBW. As the RBW changes, the sweep time (if set to **Auto**) is changed to maintain amplitude calibration.

Video bandwidth (VBW) is coupled to RBW. As the resolution bandwidth changes, the video bandwidth (if set to **Auto**) changes to maintain the ratio set by **VBW/RBW**.

When Res BW is set to **Auto**, resolution bandwidth is autocoupled to span. The ratio of span to RBW is set by **Span/RBW** (described on [page 93](#)). The factory default for this ratio is approximately 106:1 when auto coupled. When Res BW is set to **Man**, bandwidths are entered by the user, and these bandwidths are used regardless of other analyzer settings.

NOTE In zero span, the auto/manual function of this key is not applicable. When **Res BW (Auto)** is selected in non-zero span, any changes to Res BW while in zero span will revert to the Auto value when you return to non-zero span. When **Res BW (Man)** is selected in non-zero span, any changes to Res BW while in zero span will be maintained when you return to non-zero span.

A # mark appears next to Res BW on the bottom of the analyzer display when it is not coupled. To couple the resolution bandwidth, press **Res BW (Auto)** or **Auto All**.

NOTE For applications that require 6 dB resolution bandwidths, it is possible to use an equivalent 3 dB resolution bandwidth. Because the analyzer has Gaussian RBW, the equivalent 6 dB bandwidth of any RBW filter can be determined using the following formula: $6 \text{ dB RBW} = 3 \text{ dB RBW} \times 1.414$. For example, if a 6 dB RBW of 100 kHz is required, the equivalent 3 dB RBW Filter would be $100 \text{ kHz} / 1.414 = 70.7 \text{ kHz}$. The closest RBW filter for the analyzer that would be used is 68 kHz.

Key Path: **BW/Avg**

Saved State: Saved in Instrument State

Factory Preset: Auto (3 MHz)

Range: 1 Hz to 8 MHz

Remote Command:

```
[[:SENSE]:BANDwidth|BWIDth[:RESolution] <freq>
```

```
[[:SENSE]:BANDwidth|BWIDth[:RESolution] ?
```

```
[[:SENSE]:BANDwidth|BWIDth[:RESolution]:AUTO OFF|ON|0|1
```

```
[[:SENSE]:BANDwidth|BWIDth[:RESolution]:AUTO?
```

Example: BAND 1 kHz
BAND?
BWID:AUTO On
BWID:AUTO?

2.2.2 Video BW

Enables you to change the analyzer post-detection filter from 1 Hz to 8 MHz in approximately 10% steps. In addition, a wide-open video filter bandwidth (VBW) may be chosen by selecting 50 MHz. **Video BW (Auto)** selects automatic coupling of the Video BW filter to the resolution bandwidth filter using the VBW/RBW ratio set by the **VBW/RBW** key.

NOTE Sweep Time is coupled to Video Bandwidth (VBW). As the VBW is changed, the sweep time (when set to **Auto**) is changed to maintain amplitude calibration. This occurs because of common hardware between the two circuits, even though the Video BW filter is not actually “in-circuit” when the detector is set to Average. Because the purpose of the average detector and the VBW filter are the same, either can be used to reduce the variance of the result.

Although the VBW filter is not “in-circuit” when using the average detector, the Video BW key can have an effect on (**Auto**) sweep time, and is not disabled. In this case, reducing the VBW setting increases the sweep time, which increases the averaging time, producing a lower-variance trace.

When using the average detector with either **Sweep Time** set to **Man**, or in zero span, the VBW setting has *no* effect and is disabled (greyed out).

A “#” mark appears next to VBW on the bottom of the analyzer display when it is not coupled. To couple the video bandwidth, press **Video BW (Auto)** (or press **Auto All**).

Key Path: **BW/Avg**

Saved State: Saved in Instrument State

Factory Preset: Auto (3 MHz)

Range: 1 Hz to 50 MHz

Remote Command:

```
[ :SENSE ] :BANDwidth|BWIDth:VIDeo <freq>
[ :SENSE ] :BANDwidth|BWIDth:VIDeo?
[ :SENSE ] :BANDwidth|BWIDth:VIDeo:AUTO OFF|ON|0|1
[ :SENSE ] :BANDwidth|BWIDth:VIDeo:AUTO?
```

Example: BAND:VID 1 kHz
 BAND:VID?
 BWID:VID:AUTO ON
 BWID:VID:AUTO?

2.2.3 VBW/RBW

Selects the ratio between the video and resolution bandwidths. Video bandwidth wider than resolution bandwidth (VBW/RBW ratio > 1.000), provides the best peak measurements of signals such as wideband radar pulses. VBW narrower than RBW (VBW/RBW ratio < 1.000) reduces the variance of noise-like signals and makes spectral components close to the noise floor easier to view. The knob and step keys change the ratio in a 1, 3, 10 sequence. With **Preset Type** set to **Factory**, pressing **Preset** or selecting **Auto Couple**, **Auto All** sets the ratio to 1.000 X. When **VBW/RBW (Auto)** is selected, the ratio is determined as indicated below.

Table 2-1 VBW/RBW Ratio Auto Rules

Detector Mode	Noise Marker	Ratio	Notes
Peak	On	10	Noise response is estimated for wide VBW case
Negative Peak	On	10	Don't care
Average	On	0.1	Narrow VBW for low-sigma marker readout
Normal	On	0.1	Don't care (noise marker makes is not valid with normal detection.)
Sample	On	0.1	Narrow VBW for low-sigma marker readout
Peak	Off	10	Wide VBW for good impulse BW (pulsed RF)
Negative peak	Off	10	Don't care
Average	Off	0.1	Narrow VBW for low-sigma trace results
Normal	Off	1.0	Swept analysis CW signal setting
Sample	Off	1.0	Wide VBW for good impulse BW (pulsed RF)

Key Path: **BW/Avg**
 Saved State: Saved in Instrument State
 Factory Preset: Auto (1.0)
 Range: 0.00001 to 3.0e6 (3,000,000)

Remote Command:

```
[ :SENSe] :BANDwidth|BWIDth:VIDeo:RATio <number>
[ :SENSe] :BANDwidth|BWIDth:VIDeo:RATio?
[ :SENSe] :BANDwidth|BWIDth:VIDeo:RATio:AUTO OFF|ON|0|1
[ :SENSe] :BANDwidth|BWIDth:VIDeo:RATio:AUTO?
```

Example: BAND:VID:RAT 2
 BAND:VID:RAT?
 BAND:VID:RAT:AUTO 0
 BAND:VID:RAT:AUTO?

2.2.4 Average

Initiates a digital averaging routine that averages the trace points in a number of successive sweeps, resulting in trace “smoothing.” You can select the number of sweeps (average number) with the numeric keypad (*not* the knob or step keys). Increasing the average number further smooths the trace. To select the type of averaging used, press **BW/Avg, Avg/VBW Type**.

Averaging restarts when any of the following occurs:

- a new average number is entered.
- any measurement related parameter (e.g., center frequency) is changed.
- **Restart** is pressed.
- **Single Sweep** is pressed.

In single sweep, the specified number of averages is taken, then the sweep stops. In continuous sweep, the specified number of averages is taken, then the averaging continues, with each new sweep averaged in with a weight of $\frac{1}{\text{Average Number}}$ and the old average reduced by multiplying it by $\frac{\text{Average Number} - 1}{\text{Average Number}}$.

To turn off averaging, press **Average (Off)**.

Key Path: **BW/Avg**
 Saved State: Saved in Instrument State
 Factory Preset: Off, 100 averages

Range: Count: 1 to 8192

Remote Commands:

[:SENSe]:AVERAge[:STATe] OFF|ON|0|1

[:SENSe]:AVERAge[:STATe]?

[:SENSe]:AVERAge:COUNT <integer>

[:SENSe]:AVERAge:COUNT?

[:SENSe]:AVERAge:CLEAr

Remote Command Notes: For valid average data, you must re-start the trace at the beginning of a sweep. To do this remotely, first abort (:ABORT) the sweep and then initiate a single sweep (:INIT:CONT OFF).

Example: AVER ON
 AVER:COUN 100
 AVER:CLE clears the current average and restarts the averaging process.

2.2.5 Avg/VBW Type

Displays the functions that enable you to automatically or manually choose one of the following averaging scales: log-power (video), power (RMS), or voltage averaging.

NOTE When you select log-power averaging, the measurement results are the average of the signal level in logarithmic units (decibels). When you select power average (RMS), all measured results are converted into power units before averaging and filtering operations, and converted back to decibels for displaying. *Remember:* there can be significant differences between the average of the log of power and the log of the average power.

The following are the averaging processes within a spectrum analyzer, all of which are affected by this setting:

- Trace averaging (see **BW/Avg**) averages signal amplitudes on a trace-to-trace basis.
- Average detector (see **Detector, Average**) averages signal amplitudes during the time or frequency interval represented by a particular measurement point.
- Noise Marker (see **Marker Noise**) averages signal amplitudes across measurement points to reduce variations for noisy signals.
- VBW filtering adds video filtering which is a form of averaging of the video signal.

When manual is selected, the type is shown on the left side of the display with a #. When auto is selected, the analyzer chooses the type of averaging. When one of the average types is selected manually, the analyzer uses that type regardless of other analyzer settings, and sets **Avg/VBW Type** to **Man**.

Key Path: **BW/Avg** or **Auto Couple**

Saved State: Saved in Instrument State

Factory Preset: Auto (Log-power)

Remote Command:

[:SENSe] :AVERAge :TYPE RMS | LOG | SCALar

[:SENSe] :AVERAge :TYPE?

[:SENSe] :AVERAge :TYPE :AUTO OFF | ON | 0 | 1

[:SENSe] :AVERAge :TYPE :AUTO?

Example: AVER:TYPE:RMS Sets Power (RMS) averaging
 AVER:TYPE:SCAL Sets Voltage averaging
 AVER:TYPE:LOG Sets Log-Power (video) averaging

2.2.5.1 Auto

Chooses the optimum type of averaging for the current instrument measurement settings.

Auto selects Power (RMS) Averaging if **Marker Noise** is on, **Band/Intvl Power** is on, or **Detector** is set to **Man** and **Average**. It selects Voltage Averaging if **Amplitude**, **Scale Type** is set to **Lin**. For other conditions, **Auto** selects Log-Power Average.

Key Path: **BW/Avg, Avg/VBW Type**

Remote Command:

See “Avg/VBW Type” on page 89

Example: AVER:TYPE:AUTO ON

2.2.5.2 Log-Pwr Avg (Video)

Selects the logarithmic (decibel) scale for all filtering and averaging processes. This scale is sometimes call “Video” because it is the most common display and analysis scale for the video signal within a spectrum analyzer. This scale is excellent for finding CW signals near noise, but its response to noise-like signals is 2.506 dB lower than the average power of those noise signals. This is compensated for in the Marker Noise function. When this type of averaging is selected, **LgAv** appears on the left side of the display.

The equation for trace averaging on the log-pwr scale is shown below, where N is the number of averages accumulated. (In continuous sweep mode, once N has reached the Average Number, N stays at that value, providing a running average.)

$$\text{New avg} = \frac{(N - 1)\text{Oldavg} + \text{Newdata}}{N}$$

Assumes all values in decibel scale.

Key Path: **BW/Avg, Avg/VBW Type**
or **Auto Couple, Avg/VBW Type**

Remote Command:

See [“Avg/VBW Type” on page 89](#)

Example: `AVER:TYPE LOG`

2.2.5.3 Pwr Avg (RMS)

In this average type, all filtering and averaging processes work on the power (the square of the magnitude) of the signal, instead of its log or envelope voltage. This scale is best for measuring the true time power of complex signals. This scale is sometimes called RMS because the resulting voltage is proportional to the square root of the mean of the square of the voltage. When this type of averaging is selected, PAvg appears on the left side of the display.

In the equation for averaging on this scale (below), N is the number of averages accumulated. (In continuous sweep mode, once N has reached the Average Number, N stays at that value.)

$$\text{New Avg} = 10 \times \log \left(\frac{(N-1) \times 10^{\frac{\text{Old Avg}}{10}} + 10^{\frac{\text{New data}}{10}}}{N} \right)$$

Assumes all values in dB.

Key Path: **BW/Avg, Avg/VBW Type**
or **Auto Couple, Avg/VBW Type**

Remote Command:

See [“Avg/VBW Type” on page 89](#).

Example: `AVER:TYPE RMS`

2.2.5.4 Voltage Avg

In this Average type, all filtering and averaging processes work on the voltage of the envelope of the signal. This scale is good for observing rise and fall behavior of AM or pulse-modulated signals such as radar and TDMA transmitters, but its response to noise-like signals is 1.049 dB lower than the average power of those noise signals. This is compensated for in the Marker Noise function. When this type of averaging is selected, VAvg appears on the left side of the display.

In the equation for averaging on this scale (below), N is the number of averages accumulated. (In continuous sweep mode, once N has reached the Average Number, N stays at that value.)

$$\text{New Avg} = 20 \times \log \left(\frac{(N-1) \times 10^{\frac{\text{Old Avg}}{20}} + 10^{\frac{\text{New data}}{20}}}{N} \right)$$

Assumes all values in dB.

Key Path: **BW/Avg, Avg/VBW Type**
or **Auto Couple, Avg/VBW Type**

Remote Command:

See “Avg/VBW Type” on page 89.

Example: `AVER:TYPE SCAL`

2.2.6 Span/RBW

Selects the ratio between span and resolution bandwidth. A factory preset sets the ratio to 106:1. The ratio can be changed using the front-panel step keys, knob, or numeric keypad.

Key Path: **BW/Avg**

Saved State: Saved in Instrument State

Factory Preset: 106:1

Range: 2 to 10,000

History: Added with firmware revision A.02.00

Remote Command:

```
[ :SENSe ] :FREQuency:SPAN:BANDwidth[:RESolution]:RATio <value>
```

```
[ :SENSe ] :FREQuency:SPAN:BANDwidth[:RESolution]:RATio?
```

```
[ :SENSe ] :FREQuency:SPAN:BANDwidth[:RESolution]:RATio:AUTO OFF|ON|0|1
```

```
[ :SENSe ] :FREQuency:SPAN:BANDwidth[:RESolution]:RATio:AUTO?
```

Example: `FREQ:SPAN:BAND:RAT 200` sets a ratio of 200:1, and turns off the auto coupling.

```
FREQ:SPAN:BAND:RAT:AUTO ON
```

```
FREQ:SPAN:BAND:RAT?
```

2.3 Det/Demod

Displays the menu keys that control parameters associated with the detector modes.

2.3.1 Detector

Select a specific type of detector, or choose Auto to let the instrument select the appropriate detector for a particular measurement.

When discussing detectors, it is important to understand the concept of a trace “bucket.” For every trace point displayed in swept and zero-span analysis, there is a finite time during which the data for that point is collected. The analyzer has the ability to look at all of the data collected during that time and present a single point of trace data based on the detector mode. We call the interval during which the data for that trace point is being collected, the “bucket.” Thus, a trace is more than a series of single points. It is actually a series of trace “buckets.” The data may be sampled many times within each bucket.

In swept analysis, the time interval of data collection for a display bucket also represents a frequency interval. In FFT analysis, the bucket represents just a frequency interval. The detector determines the relationship between the spectrum computed by the FFT and the single data point displayed for the bucket.

When the **Detector** choice is **Auto**, the detector selected depends on marker functions, trace functions, and the trace averaging function.

See “[Auto Rules For Detector Selection](#)” on page 97 for information on the **Auto** detector selection.

When you manually selected a detector (instead of selecting **Auto**), that detector is used regardless of other analyzer settings.

The detector choices are:

- The **Sample** detector displays the instantaneous level of the signal at the center of the bucket represented by each display point.
- The **Normal** detector displays the peak of CW-like signals and maximums and minimums of noise-like signals.
- The **Average** detector displays the average of the signal within the bucket. The averaging method depends upon **Avg Type** selection (voltage, power or log scales).
- The **Peak** detector displays the maximum of the signal within the bucket.
- The **Negative Peak** detector displays the minimum of the signal within the bucket.

Because they may not find a spectral component's true peak, neither average nor sample detectors measure amplitudes of CW signals as accurately as peak or normal, but they do measure noise without the biases of peak detection.

The detector in use is indicated on the left side of the display. If the detector has been manually selected, a # appears next to it.

TIP RMS Detection

To measure the average power (RMS voltage) in each display point, set **Detector** to **Average**, and verify that **Avg/VBW Type** is set to **Pwr Avg (RMS)**.

Key Path: **Det/Demod**

State Saved: Saved in Instrument State

Factory Preset: Normal, Auto Coupled

Remote Command:

```
[ :SENSe ] :DETECTOR [ :FUNCTION ] AVERAge | NEGAtive | NORMAl | POSitive | SAMPlE | RMS
```

```
[ :SENSe ] :DETECTOR [ :FUNCTION ] ?
```

The query returns a name that corresponds to the detector mode as shown by the following terms:

NORM	Normal
AVER	Average
POS	Positive peak
SAMP	Sample
NEG	Negative peak

Example: DET POS

2.3.1.1 Auto

The system selects normal detection as the default, but if a condition arises where a different type of detection scheme would be better utilized, the system uses the alternate scheme. For example, when in Auto mode, the Marker Noise function uses Average detection because the system determines that the average detector has a better speed/variance trade-off for noise-type signals.

Refer to [Figure 2-1](#), which shows a decision tree of how detection type is determined.

Figure 2-1 Auto Rules For Detector Selection

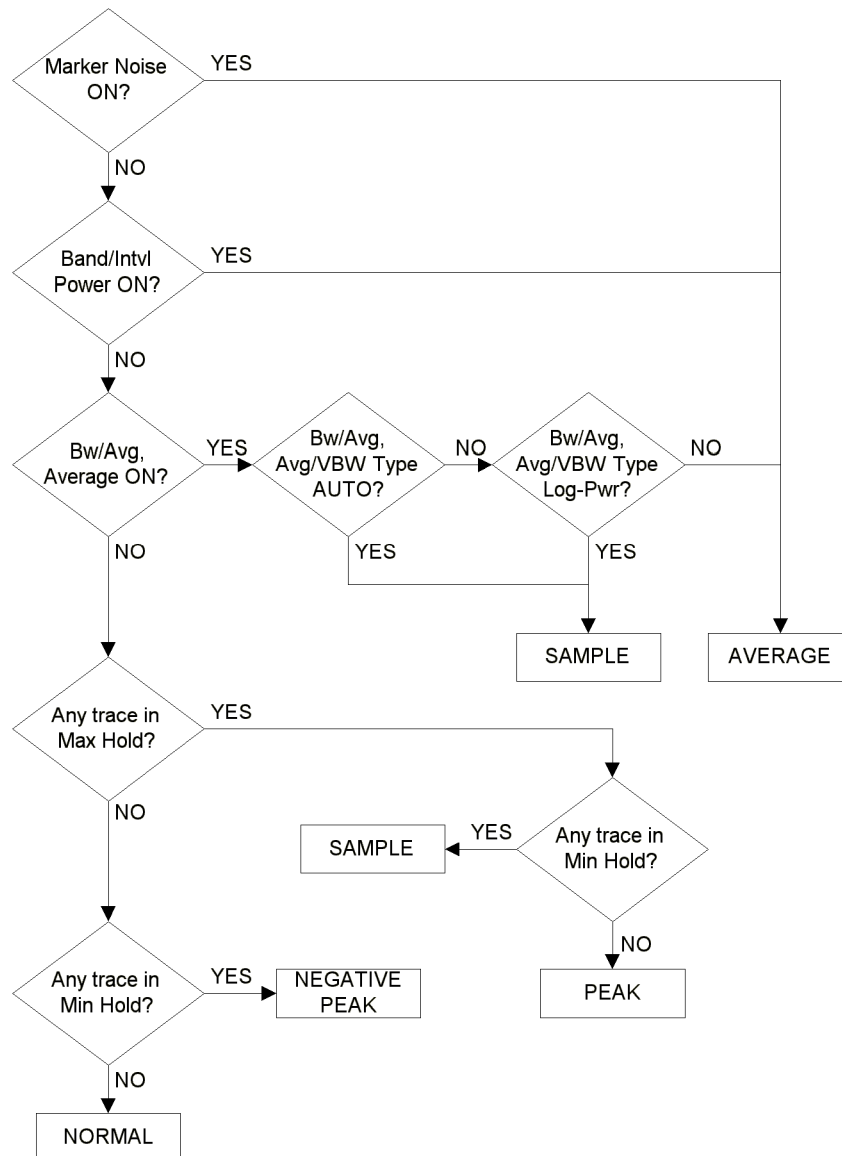

Key Path: **Det/Demod, Detector**

Factory Preset: On, Normal

Remote Command:

```
[[:SENSe]:DETECTOR:AUTO OFF|ON|0|1
```

```
[[:SENSe]:DETECTOR:AUTO?
```

Example: DET:AUTO ON

2.3.1.2 Normal

Displays the peak-detected level in the interval (bucket) being displayed when the signal is CW-like. If the signal is noise-like (within a bucket the signal both rose and fell), the even bucket shows the peak (maximum) within a two-bucket interval, and the odd bucket shows the negative peak (minimum). Gain is increased to compensate for the effects of faster sweep rates, to keep the displayed value accurate.

When **Normal** is selected, **Norm** appears on the left side of the display.

Key Path: **Det/Demod**

Remote Command:

See “[Detector](#)” on page 95

Example: DET NORM

2.3.1.3 Average

For each interval (bucket) in the trace, Average detection displays the average of all samples within the interval using one of the following averaging methods:

- log (also known as video)
- power (also known as RMS)
- voltage envelope

To explicitly set the averaging method, use the **BW/Avg, Avg/VBW Type** key. The combination of the average detector and the power method is equivalent to what is sometimes referred to as “RMS detection.” When the method (**Avg/VBW Type**) is set to **Pwr Avg**, and **Detector** is set to **Average**, the RMS method is selected.

When **Average** is selected, **Avg** appears on the left side of the display.

Key Path: **Det/Demod, Detector**

Dependencies/

Couplings: Use of Average affects the VBW setting. See **BW/Avg, VBW**.
When in Average detection, video trigger is not available.

Remote Command:

See “[Detector](#)” on page 95.

Example: DET AVER

2.3.1.4 Peak

For each interval (bucket) in the trace, Peak detection displays the highest amplitude within the interval. Peak detection is used for CW measurements and some pulsed-RF measurements. For swept analysis, peak detection basically obtains the maximum video signal between the end of the last bucket and the start of the next one. Gain is increased to compensate for the effects of faster sweep rates, to keep the displayed value accurate. For FFT analysis, the highest spectral amplitude is displayed, even if that peak amplitude falls between samples of the spectrum computed in the FFT process.

When **Peak** is selected, Peak appears on the left side of the display.

Key Path: **Det/Demod, Detector**

Remote Command:

See [“Detector” on page 95](#)

Example: DET POS

2.3.1.5 RMS (Remote Command Only)

Selects the Average Detector. If **BW/Avg, Avg/VBW Type** is set to **Auto** (or **Pwr Avg**) this will yield the RMS voltage (average power) for each trace point. (See 3.4.1.3, Average)

Key Path: There is no key selection for this setting, but you can access it by using **Average Detector** (see [“Average” on page 98](#)).

Remote Command:

See [“Detector” on page 95](#).

Example: DET RMS

2.3.1.6 Sample

The sample detector displays the instantaneous level of the signal at the center of the interval (bucket) represented by each trace point.

Sample detection is primarily used to display noise or noise-like signals.

Sample detection is not best for amplitude measurements of CW-like signals for two reasons. First, the peak response to a signal can occur between samples, so unless the Span to RBW ratio is lower than usual, the highest sample can be well below the peak signal amplitude. Second, for the high sweep rates normally used, the peak response of the RBW filters is up to -0.5 dB. This sweeping error is compensated when using the peak and normal detectors by changing the overall gain. But the gain is not changed when in the sample detector, because to do so would cause errors in the response to noise.

When **Sample** is selected, Samp appears on the left side of the display.

Key Path: **Det/Demod, Detector**

Remote Command:

See [“Detector” on page 95](#)

Example: DET SAMP

2.3.1.7 Negative Peak

For each interval (bucket) in the trace, **Negative Peak** detection displays the lowest sample within the interval. Negative peak detection is similar to peak detection, but selects the minimum video signal.

When **Negative Peak** is selected, NPk appears on the left side of the display.

Key Path: **Det/Demod, Detector**

Remote Command:

See [“Detector” on page 95](#)

Example: DET NEG

2.4 Display

Displays menu keys that enable you to control certain items on the display of the analyzer.

NOTE CCDF and SEM measurements have measurement specific **Display** menus. For the Display description for a CCDF measurement, see “[Display \(Complementary Cumulative Distribution Function—CCDF\)](#)” on page 385; for the SEM measurement, see “[Display \(Spectrum Emissions Mask—SEM\)](#)” on page 479.

Key Path: Front-panel key

2.4.1 Full Screen

When **Full Screen** is pressed the measurement window expands horizontally over the entire instrument display. It turns on/off the display of the softkey labels. Pressing any other key that results in a new menu will cancel the full screen function.

Key Path: **Display**

State Saved: Not saved in state.

Factory Preset: Off

Factory
Default: Off

History: Added with firmware revision A.02.00

Remote Command:

```
:DISPlay:FSCReen[:STATe] OFF|ON|0|1
```

```
:DISPlay:FSCReen[:STATe]?
```

Example: DISP:FSCR ON

2.4.2 Display Line

Activates an adjustable horizontal line that is used as a visual reference line. The line has an amplitude value that corresponds to its vertical position relative to the reference level. The value of the display line appears on the left side of the display below the label **D1**. The display line can be adjusted using the step keys, knob, or numeric keypad. The units of Display Line are determined by the **Y-Axis Units** setting under **Amplitude**.

Key Path: **Display**

State Saved: Saved in instrument state.

Factory Preset: -25 dBm, Off

Factory

Default: -25 dBm, Off

Terminators: dBm, mV, uV

Range: -370 dBm to 30 dBm

Remote Command:

```
:DISPlay:WINDow:TRACe:Y:DLINe <ampl>
```

```
:DISPlay:WINDow:TRACe:Y:DLINe?
```

```
:DISPlay:WINDow:TRACe:Y:DLINe:STATe OFF|ON|0|1
```

```
:DISPlay:WINDow:TRACe:Y:DLINe:STATe?
```

Example: :DISP:WIND:TRAC:Y:DLIN -32 dBm

:DISP:WIND:TRAC:Y:DLIN:STAT OFF

2.4.3 Display Line

Activates an adjustable horizontal line that is used as a visual reference line. The line has an amplitude value that corresponds to its vertical position relative to the reference level. The value of the display line appears on the left side of the display below the label **D1**. The display line can be adjusted using the step keys, knob, or numeric keypad. The units of Display Line are determined by the **Y-Axis Units** setting under **Amplitude**.

Key Path: **Display**

State Saved: Saved in instrument state.

Factory Preset: -25 dBm, Off

Factory

Default: -25 dBm, Off

Terminators: dBm, mV, uV

Range: -370 dBm to 30 dBm

Remote Command:

```
:DISPlay:WINDow:TRACe:Y:DLINe <ampl>
```

```
:DISPlay:WINDow:TRACe:Y:DLINe?
```

```
:DISPlay:WINDow:TRACe:Y:DLINe:STATe OFF|ON|0|1
```

```
:DISPlay:WINDow:TRACe:Y:DLINe:STATe?
```

Example: :DISP:WIND:TRAC:Y:DLIN -32 dBm

:DISP:WIND:TRAC:Y:DLIN:STAT OFF

2.4.4 Active Fctn Position

Selects the screen position for the Active Function Display. Depending on the type of trace data being viewed, you can move the Active Function Display position for less visual interference with your screen data.

Key Path: **Display**

Readback: The selection of the position to display the active function (Top, Center, Bottom) reads back to line 3 of this key.

State Saved: Not saved in instrument state, survives power cycle and preset.

Factory Preset: No effect, persistent variable, survives power cycle and preset.

Factory Default: Center. Pressing **System**, **Restore Sys Defaults** will reset to factory defaults.

History: Added with firmware revision A.04.00

Remote Command:

```
:DISPlay:AFUNction:POSition BOTtom|CENTer|TOP
```

```
:DISPlay:AFUNction:POSition?
```

Example: :DISP:AFUN:POS BOT

2.4.4.1 Top

Displays the active function in the top-left corner of the display.

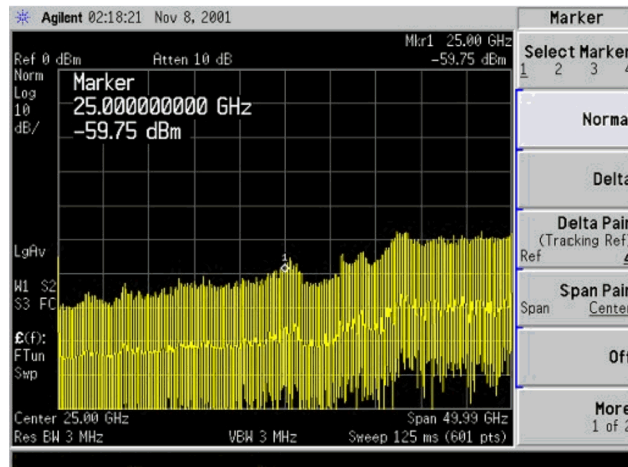

Key Path: **Display**, **Active Fctn Position**

Readback: Top reads back to line 3 of this key.

State Saved: Not saved in instrument state, survives power cycle and preset.

Factory Preset: No effect, persistent variable, survives power cycle and preset.

Factory
 Default: Center
 History: Added with firmware revision A.04.00

Remote Command:

:DISPlay:AFUNction:POSition TOP

Example: :DISP:AFUN:POS TOP

2.4.4.2 Center

Displays the active function in the center-left side of the display.

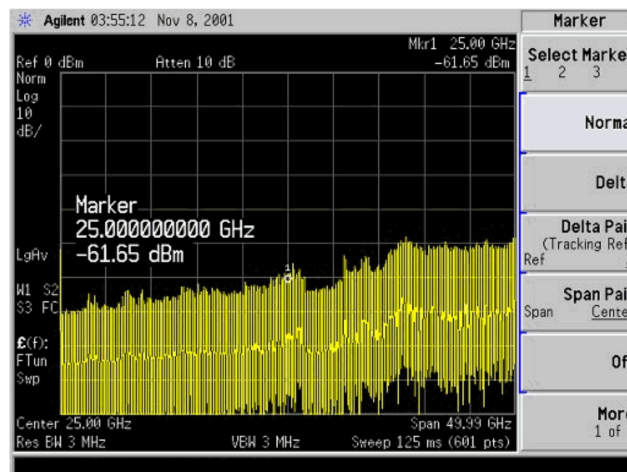

Key Path: **Display, Active Fctn Position**
 Readback: Center reads back to line 3 of this key.
 State Saved: Not saved in instrument state, survives power cycle and preset.
 Factory Preset: No effect, persistent variable, survives power cycle and preset.

Factory
 Default: Center
 History: Added with firmware revision A.04.00

Remote Command:

:DISPlay:AFUNction:POSition CENTer

Example: :DISP:AFUN:POS CENT

2.4.4.3 Bottom

Displays the active function in the bottom-left corner of the display.

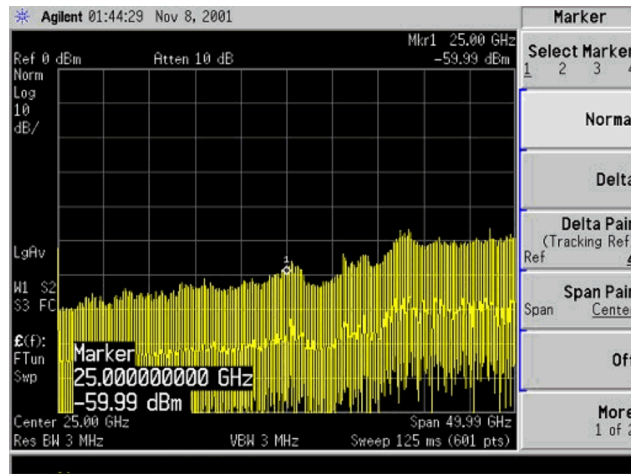

Key Path: **Display, Active Fctn Position**

Readback: **Bottom** reads back to line 3 of this key.

State Saved: Not saved in instrument state, survives power cycle and preset.

Factory Preset: No effect, persistent variable, survives power cycle and preset.

Factory

Default: **Center**

History: Added with firmware revision A.04.00

Remote Command:

:DISPlay:AFUNction:POSition BOTtom

Example: :DISP:AFUN:POS BOT

2.4.5 Limits

Limit lines can be defined to compare the data to your defined limits and indicate a pass or fail condition. **Limits** accesses menus that allow you to create, modify, and change the properties of limit lines. There are two limit lines in the instrument.

Key Path: **Display**

State Saved: Not saved in instrument state.

SCPI Status Bits/

OPC Dependencies: No OPC dependencies.

Factory

Default: Unaffected by system defaults.

History: Added with firmware revision A.03.00

Remote Command:

```
:CALCulate:LLINE[1]|2:DATA
<x-axis>, <ampl>, <connected>{,<x-axis>,<ampl>,<connected>}
:CALCulate:LLINE[1]|2:DATA?
```

Defines the limit line values, and destroys all existing data. Up to 200 points may be defined for each limit using the following parameters.

- <x-axis>** can be frequency or time values as specified by the following command:
:Calculate:LLINE:CONTROL:DOMAIN.
Frequencies are always in Hz. Time is always in seconds. No unit is allowed in this parameter.
Range: -30 Gs to +30 Gs for time limits, -3 kHz to +350 GHz for frequency limits.
- <ampl>** amplitude values are always in units of dBm. Up to two amplitude values can be provided for each x-axis value, by repeating <x-axis> in the data list. No unit is allowed in this parameter.
Range: -140 dBm to +100 dBm
- <connected>** connected values are either "0" or "1." A "1" means this point should be connected to the previously defined point to define the limit line. A "0" means that it is a point of discontinuity and is not connected to the preceding point. The *connected* value is ignored for the first point.

```
:CALCulate:LLINE[1]|2:DATA:MERGe
<x-axis>, <ampl>, <connected>{,<x-axis>,<ampl>,<connected>}
```

Adds the points with the specified values to the current limit line, allowing you to merge limit line data. Up to two amplitude values are allowed for each x value. If more than 200 points are entered to be merged, the first 200 points are merged into the existing limit, then an error 'too many DATA entries' is reported.

Remote Command Notes: Up to 200 points total may be defined for each limit.

Example: CALC:LLIN1:DATA 1000000000, -20,0,2000000000, -30,1

2.4.5.1 Limit 1 or Limit 2

Selects Limit 1 or Limit 2 for modification.

Key Path: **Display, Limits**

State Saved: Not saved in instrument state.

History: Added with firmware revision A.03.00

2.4.5.1.1 Type (Upper Lower)

Allows you to define the limit you are editing as either an upper or lower limit. An **Upper** limit fails if the trace exceeds the limit. A **Lower** limit fails if the trace falls below the limit.

Key Path: **Display, Limits, Limit 1**

Display, Limits, Limit 2

Dependencies/

Couplings: If a margin has already been set for this limit line, and this key is used to change the limit type, then the margin value is reset to 0 dB.

State Saved: Not saved in instrument state. Survives power cycle and preset. The limit-line data is saved in files.

Factory Preset
and *RST: Not affected by preset.

Factory
Default: Limits are off by default. Upper for **Limit 1**, then a limit line is created.
Lower for **Limit 2**, then a limit line is created.

History: Added with firmware revision A.03.00

Remote Command:

```
:CALCulate:LLINE [1] | 2:TYPE UPPER|LOWer
```

```
:CALCulate:LLINE [1] | 2:TYPE?
```

Example: :CALC:LLIN2:TYPE LOW sets limit line 2 as a lower limit.
:CALC:LLIN1:TYPE? responds with the limit line 1 limit type.

2.4.5.1.2 Limit Display

Turns limit-line display **On** or **Off**. Either **Limit** or **Margin**, as well as **Test**, must be turned on to turn on a limit test.

Key Path: **Display, Limits, Limit 1**

Display, Limits, Limit 2

State Saved: Not saved in instrument state.

SCPI Status Bits/

OPC Dependencies: No OPC dependencies.

Factory Preset
and *RST: Off

Factory
Default: Off (when a limit line is created)

History: Added with firmware revision A.03.00

Remote Command:

```
:CALCulate:LLINe [1] | 2:DISPlay OFF|ON|0|1
```

```
:CALCulate:LLINe [1] | 2:DISPlay? queries the current limit line.
```

Example: :CALC:LLIN2:DISP OFF turns off the display of the limit lines.

 :CALC:LLIN1:DISP? tells you whether the limit lines are being displayed.

2.4.5.1.3 Limit Test

Turns the testing of the limit line **On** or **Off**. If the trace is at or within the bounds of the set limit or margin, PASS LIMIT# or PASS MARGIN# is displayed in green in the upper-left corner of the measurement area where # is the number of the selected limit line.

Only positive margins are allowed for lower limits and only negative margins are allowed for upper limits. If the trace is out of the limit or margin boundaries, FAIL LIMIT# or FAIL MARGIN# is displayed in red. The results for Limit 2 are displayed below those for Limit 1. Either **Limit** or **Margin** must be turned on for **Test** to be turned on.

NOTE The color of your screen annotation is dependent on your analyzer settings and may not correspond to the colors described above.

Key Path: **Display, Limits, Limit 1**

Display, Limits, Limit 2

Dependencies/

Couplings: If either of the limits or margins are turned off, the test cannot be turned on. That is, if both **Limit** and **Margin** are set to **Off**, then the test is turned off automatically.

State Saved: Not saved in instrument state.

**Factory Preset
and *RST:** Off

**Factory
Default:** Off (when a limit line is created)

History: Added with firmware revision A.03.00

Remote Command:

```
:CALCulate:LLINe [1] | 2:STATe OFF|ON|0|1 to turn limit lines on or off.
```

```
:CALCulate:LLINe [1] | 2:STATe?
```

```
:CALCulate:LLINe [1] | 2:FAIL?
```

Example: :CALC:LLIN:STATE 1 sets limit line 1 test on.

 :CALC:LLIN:STATE? responds with the limit line test status.

:CALC:LLIN:FAIL? Queries the status of the limit-line testing. Returns a "0" if the data passes, and returns a "1" if there is a failure. This query value is valid only if **Margin** or **Test** is **On**.

2.4.5.1.4 Margin (On Off)

Turns margin **On** or **Off**. Selecting **On** allows you to set a limit-line offset for the selected limit line. Only positive margins are allowed for lower limits and only negative margins are allowed for upper limits. The margin lines are displayed in a light grey color. If the limit lines are off and margin is on, the trace is checked against the margin, then a pass or fail margin is displayed. Either **Limit** or **Margin**, as well as **Test**, must be turned on to turn on a limit test.

Key Path: **Display, Limits, Limit 1**

Display, Limits, Limit 2

Dependencies/

Couplings: If neither of the limits or margins are turned on, the test cannot be turned on. That is, if both **Limit** and **Margin** are set to **Off**, then the test is turned off automatically. If a margin has been set for this limit line, and this key is used to change the limit type, then the margin values is reset to 0 dB.

State Saved: Not saved in instrument state. Survives preset and power cycle.

Factory Preset
and *RST: Off

Factory
Default: Off (when a limit line is created). Default value is not affected by a preset.

Fundamental
Units: dB

Terminators: dB, -dB

Default Terminator: dB

Resolution: 0.1 dB

Knob Increment: -0.1 dB (Upper); 0.1 dB (Lower)

Step Key
Increment: -1 dB (Upper); 1 dB (Lower)

Range: 0 to -40 dB (Upper); 0 to 40 dB (Lower)

History: Added with firmware revision A.03.00

Remote Command:

:CALCulate:LLINe [1] | 2:MARGin:STATe OFF|ON|0|1 turns on margins on or off. If the margin and limit display are both turned off, limit test is automatically turned off.

:CALCulate:LLINe [1] | 2:MARGin:STATe?

Responds with the margin state; 0 = off 1 = on.

```
:CALCulate:LLINE[1] | 2:MARGIN <ampl_rel>
```

Defines the amount of measurement margin that is added to the designated limit line.

```
:CALCulate:LLINE[1] | 2:MARGIN?
```

Responds with the margin offset value.

2.4.5.1.5 Edit

Pressing **Edit** accesses menus for editing limit lines and for accessing the limit-line table editor. Navigation through the limit-line table is achieved by using the front-panel arrow and tab keys. Entering data in each field navigates to the next field. New limit segments will only be applied after the editor is closed.

Pressing **Return**, or any key that is not associated with the editor, will close the limit-line table editor.

NOTE Refer to your Getting Started guide for more information about navigation within tables using your front-panel arrow and tab keys.

Key Path: **Display, Limits, Limit 1**

Display, Limits, Limit 2

Factory Preset
and *RST: Exits the edit mode.

History: Added with firmware revision A.03.00

2.4.5.1.5.1 Point

Up to 200 points may be defined for each limit line using **Point**. Enter the point number to be created or edited using the numeric keypad, then press **Enter**, or use the front-panel knob, or step keys to move to an existing point. The step-up key takes you to the next point, while the step-down key takes you to the previous point. After selecting a point, **Frequency** (or **Time**, depending on x-axis selection) becomes active.

Key Path: **Display, Limits, Limit 1, Edit**

Display, Limits, Limit 2, Edit

State Saved: Not affected by state.

Factory Preset
and *RST: 1

Factory
Default: 1

Terminators: Enter

Default Terminator: Enter

Resolution: 1

Knob Increment: 1

Step Key
Increment: 1

History: Added with firmware revision A.03.00

Range: 1 to 200

2.4.5.1.5.2 Frequency (or Time)

Note that this key label changes to **Time** if **X Axis Units** has been selected. Pressing this key allows you to enter a value for a limit point in frequency (or time). After entering a value, the limit table is sorted to place the value in the correct order. For a new point, **Amplitude** defaults to 0 dBm and **Connected** defaults to **Yes**. **Amplitude** then becomes active.

Key Path: **Display, Limits, Limit 1, Edit**
 Display, Limits, Limit 2, Edit

Dependencies/
Couplings: Limit-line points are selected according to the X-axis units selected, for example if frequency is selected as your X-axis units, then the limit points are frequency values. Also, if both upper and lower limit lines are selected for the trace then both need to be defined using the same X-axis units.

Fundamental
Units: Hz, s

Factory Preset
and *RST: 300 MHz; 120 Ms

Terminators: Hz, s

Default Terminator: Hz (frequency), s (time)

Knob Increment: 0.2 MHz, 30 Ms

Step Key
Increment: 20 MHz, 12 Ms

Range: -3 kHz to 350 GHz; -30 Gs to 30 Gs

History: Added with firmware revision A.03.00

2.4.5.1.5.3 Amplitude

Pressing **Amplitude** allows you to enter the amplitude value for the current limit point. After entering a value, **Connected** becomes active. If a front-panel arrow key is pressed without entering a value, the current **Amplitude** and **Connected** values of the point are selected. If the up arrow is pressed, the point number automatically increments to allow entry of the amplitude of the next point. If it is a new point, the **Frequency** may also be entered for the new point.

Key Path: **Display, Limits, Limit 1, Edit**
 Display, Limits, Limit 2, Edit

Factory Preset
and *RST: 0 dBm

Fundamental
Units: dBm

Terminators: dBm

Default Terminator: dBm

Resolution: 0.1 dBm

Knob Increment: 0.1 dBm

Step Key
Increment: 10 dBm

Range: -140 dBm to 100 dBm

History: Added with firmware revision A.03.00

2.4.5.1.5.4 Connected To Previous Pt

A current point may be connected to the previous point by pressing **Yes**. No limit testing is performed between disconnected points. Pressing this key when the Connected field is selected toggles the connected value of the current point and increments the Point number to allow entry or editing of the Frequency of the next point. If an arrow key is pressed without entering a value, the current Connected value of the point is selected. If an arrow key is pressed, the Point number automatically increments to allow entry of the Connected value of the next point. If it is a new point, the **Frequency** may be entered for the new point

Key Path: **Display, Limits, Limit 1, Edit**

Display, Limits, Limit 2, Edit

Factory Preset
and *RST: Yes

Factory
Default: Yes

Knob Increment: Toggles to other selection.

Step Key
Increment: Toggles to other selection

History: Added with firmware revision A.03.00

2.4.5.1.5.5 Delete Point

Deleting the current limit point can be achieved by pressing **Delete Point**. You will be prompted with the message *If you are sure, press key again to delete.* Pressing **Delete Point** again will delete the limit point.

Key Path: **Display, Limits, Limit 1, Edit**

Display, Limits, Limit 2, Edit

History: Added with firmware revision A.03.00

2.4.5.1.6 Delete Limit

Deleting the current limit set can be achieved by pressing **Delete**. You will be prompted with the message *If you are sure, press key again to delete.* Pressing **Delete** again will delete the limit set.

Key Path: **Display, Limits, Limit 1**

Display, Limits, Limit 2

Factory Preset
and *RST: Off

History: Added with firmware revision A.03.00

Remote Command:

:CALCulate:LLINE [1] |2:DElete

Example: :CALC:LLIN:DEL deletes limit line/margin 1 (LLIN defaults to Limit Line 1)

2.4.5.1.7 Freq Interp

This key is greyed out if **Time** is the selected **X Axis Units**. Sets the interpolation to linear or logarithmic for the specified limiting points set, allowing you to determine how limit trace values are computed between points in a limit table. The available interpolation modes are linear and logarithmic. If the linear (**Lin**) mode is used for both frequency and amplitude, a straight line is used when interpolating between points in a limit table. If frequency interpolation is logarithmic (**Log**), frequency values between limit points are computed by first taking the logarithm of both the table values and the intermediate value. A linear interpolation is then performed in this logarithmic frequency space. An exactly analogous manipulation is done for logarithmic amplitude interpolation.

NOTE If two amplitude values are entered for the same frequency, a single vertical line is the result. In this case, if an upper line is chosen, the amplitude of lesser frequency (amplitude 1) is tested. If a lower line is chosen, the amplitude of greater frequency (amplitude 2) is tested.

For linear amplitude interpolation and linear frequency interpolation, the interpolation is computed as:

$$y = \frac{y_{i+1} - y_i}{f_{i+1} - f_i}(f - f_i) + y_i$$

For linear amplitude interpolation and log frequency interpolation, the interpolation is computed as:

$$y = \frac{y_{i+1} - y_i}{\log f_{i+1} - \log f_i}(\log f - \log f_i) + y_i$$

For log amplitude interpolation and linear frequency interpolation, the interpolation is computed as:

$$\log y = \frac{\log y_{i+1} - \log y_i}{f_{i+1} - f_i}(f - f_i) + \log y_i$$

For log amplitude interpolation and log frequency interpolation, the interpolation is computed as:

$$\log y = \frac{\log y_{i+1} - \log y_i}{\log f_{i+1} - \log f_i}(\log f - \log f_i) + \log y_i$$

Key Path: **Display, Limits, Limit 1**

Display, Limits, Limit 2

State Saved: Persistent; retains settings, even through a power cycle.

Factory Preset
 and *RST: Log

History: Added with firmware revision A.03.00

Remote Command:

```
:CALCulate:LLINe [1] | 2:CONTRol:INTerpolate:TYPE LOGarithmic|LINear
:CALCulate:LLINe [1] | 2:CONTRol:INTerpolate:TYPE?
```

Example: :CALC:LLIN2:CONT:INT:TYPE LIN sets limit line 2 frequency interpolation to linear.

2.4.5.1.8 Amptd Interp

Allows you to determine how limit trace values are computed between points in a limit table. The available interpolation modes are linear (**Lin**) and logarithmic (**Log**). If the linear mode is used for both frequency and amplitude, a straight line is used when interpolating between points in a limit table. This function does not work in zero span (when the analyzer is in time domain). Refer to the "Note" in [“Freq Interp” on page 118](#) for more information.

NOTE Interpolation modes determine how limit values are computed between points in the limit table. The appearance of a limit trace is also affected by the amplitude scale, which may be linear or logarithmic.

Key Path: **Display, Limits, Limit 1**

Display, Limits, Limit 2

State Saved: Persistent; retains settings, even through a power cycle.

Factory Preset and *RST: Not affected by preset

Factory Default: Log for a new limit.

History: Added with firmware revision A.03.00

Remote Command:

```
:CALCulate:LLINe [1] | 2:AMPLitude:INTerpolate:TYPE LOGarithmic|LINear
:CALCulate:LLINe [1] | 2:AMPLitude:INTerpolate:TYPE?
```

Example: :CALC:LLIN:AMPLLINT:TYPE LOG sets limit lines 1 amplitude interpolation to LOG.

 :CALC:LLIN:AMPLLINT:TYPE? responds with the limit line interpolation type.

2.4.5.2 X Axis Units

Selects how the limit-line segments are defined. Pressing **X Axis Units** selects whether the limit lines will be entered using frequency (**Freq**) or sweep time (**Time**) to define the segments. They can be specified as a table of limit-line segments of amplitude versus frequency, or of amplitude versus time. A time value of zero corresponds to the start of the sweep, which is at the left edge of the graticule. Switching the limit-line definition between **Freq** and **Time** will erase both of the current limit lines. The following message will appear on screen.

Changing X axis units will delete all limits. If you are sure, press key again to change units.

CAUTION Changing this setting deletes all existing limit data from the analyzer. In other words, if a limit line has already been defined, changing the units clears the existing limit line.

Press **X Axis Units** again to purge both limit lines and to switch between frequency and time.

Key Path: **Display, Limits**

Factory

Default: Frequency for a new limit.

History: Added with firmware revision A.03.00

Remote Command:

```
:CALCulate:LLIN:CONTrol:DOMain FREQ|TIME
```

```
:CALCulate:LLIN:CONTrol:DOMain?
```

Remote Command Notes: For **TIME**, the limit line segments are placed on the spectrum analyze display with respect to the sweep time setting of the analyzer, with 0 at the left edge of the display.

For **FREQ**, segments are placed according to the frequency that is specified for each segment.

Example: `:CALC:LLIN:CONT:DOM FREQ` sets limit lines 1 and 2 x-axis units to frequency.

`:CALC:LLIN:CONT:DOM TIME` sets limit lines 1 and 2 x-axis units to time.

`:CALC:LLIN:CONT:DOM?` responds with limit lines 1 and 2 x-axis unit type.

2.4.5.3 Limits (Fixed Rel)

Specifies whether the current limit lines are fixed or relative.

Pressing **Limits** to choose fixed (**Fixed**) or relative (**Rel**) limit lines. The fixed (**Fixed**) type uses the current limit lines as a reference with fixed frequency and amplitude values. The relative (**Rel**) setting results in the current limit-line value to be relative to the displayed center frequency and reference level amplitude values. When limit lines are specified with time, rather than frequency, the **Rel** setting only affects the amplitude values. The current amplitude values will be relative to the displayed reference level amplitude, but the time values will always start at the left edge of the graticule.

For example, assume you have a frequency limit line. If the limit line is specified as fixed (**Fixed**) entering a limit line segment with a frequency coordinate of 300 MHz displays the limit line segment at 300 MHz. If the same limit line table is specified as relative (**Rel**), it is displayed relative to the analyzer center frequency and reference level. If the center frequency is at 1.0 GHz, a relative limit line segment with a frequency coordinate of 300 MHz will display the limit line segment at 1.3 GHz. If the amplitude component of the relative limit line segment is -10 dB, the - 10 dB is added to the reference level value to obtain the amplitude of the given segment (reference level offset included).

A limit line entered as **Fixed** may be changed to **Rel**, and one entered as **Rel** may be changed to **Fixed**. When changing between fixed and relative limit lines, the frequency and amplitude values in the limit line table change so that the limit line remains in the same position for the current frequency and amplitude settings of the analyzer. If a time and amplitude limit line is used, the amplitude values change but the time values remain the same.

Key Path: **Display, Limits**

Factory

Default: Fixed for a new limit.

History: Added with firmware revision A.03.00

Remote Command:

NOTE If you need to change the domain with:CALCulate:LLINe:CONTRol:DOMain, do it before this command. Changing the domain deletes all the existing limit line values.

```
:CALCulate:LLINe:CMODE FIXed|RELative
```

```
:CALCulate:LLINe:CMODE?
```

Example: :CALC:LLIN:CMOD FIX sets limit lines 1 and 2 limits to fixed.

2.4.5.4 Delete All Limits

Deletes the selected limit line. Pressing **Delete Limits** purges the data from the limit-line tables. Pressing **Delete Limits** after the prompt, If you are sure, press key again to delete, will delete the limits.

Key Path: **Display, Limits**

Factory Preset
and *RST: Not affected by preset.

History: Added with firmware revision A.03.00

Remote Command:

:CALCulate:LLINe:ALL:DELeTe

Example: :CALC:LLIN:ALL:DEL deletes all of the data points for limits lines 1 and 2.

2.4.6 Title

Displays menu keys that enable you to change or clear a title on your display.

Key Path: **Display**

2.4.6.1 Change Title

Allows you to write a title across the top of the display. Press **Change Title** to access the Alpha Editor Menus that contain available characters and symbols. You may also use the numeric keypad to enter numbers. Press **Enter** or **Return** to complete the entry. Press **ESC** to cancel the entry and preserve your existing title.

The display title will remain until you press **Change Title** again, or you recall a trace or state, or a

Factory Preset is performed. A title can also be cleared by pressing **Title, Clear Title**.

Pressing this key cancels any active function.

Key Path: **Display, Title**

State Saved: Saved in instrument state.

Remote Command:

:DISPlay:ANNotation:TITLe:DATA <string>

:DISPlay:ANNotation:TITLe:DATA?

Example: DISP:ANN:TITL:DATA "This Is My Title"

2.4.6.2 Clear Title

Allows you to clear a title from the front-panel display. Once cleared, the title cannot be retrieved.

Key Path: **Display, Title**

Factory Preset: No title

Remote Command:

There is no equivalent command, but the example below shows how to enter an empty title.

Example: `DISP:ANN:TITL:DATA "TEST 3"`

2.4.7 Preferences

Accesses menu keys which allow you to turn the graticule and annotation on or off.

Key Path: **Display**

State Saved: Saved in instrument state.

Factory Preset
and *RST: No title

Factory
Default: n/a

History: Added with firmware revision A.03.00

2.4.7.1 Graticule (On Off)

Pressing Graticule turns the display graticules **On** or **Off**.

Key Path: **Display**

Factory Preset
and *RST: On

Factory
Default: On

Terminators: Enter

History: Added with firmware revision A.03.00

Remote Command:

`:DISPlay:WINDow:TRACe:GRATicule:GRID[:STATe] OFF | ON | 0 | 1`

`:DISPlay:WINDow:TRACe:GRATicule:GRID[:STATe]?`

Example: `DISP:WIND:TRAC:GRAT:GRID OFF`

2.4.7.2 Annotation

Turns the screen annotation on or off for all windows, however, menu key annotation will remain on the display. The screen annotation may not be required for prints or during remote operation.

Key Path: **Display**

Factory Preset
and *RST: **On**

Remote Command:

:DISPlay:WINDow:ANNotation[:ALL] OFF | ON | 0 | 1

:DISPlay:WINDow:ANNotation[:ALL]?

Example: DISP:WIND:ANN OFF

2.4.8 Display Enable (Remote Command Only)

Turns the display on/off. If enable is set to off, the display will appear to blank. This can make the measurement run faster since the instrument does not have to update the display after every data acquisition. There is often no need to update the display information when using remote operation.

- Sending SYSTem:PRESet or *TST commands will turn it on. *RST will not.

Key Path: None, no front-panel control.

State Saved: Not saved in instrument state.

Factory Preset: **On**

Factory
Default: **On**

Remote Command:

:DISPlay:ENABle OFF | ON | 0 | 1

:DISPlay:ENABle?

Example: DISP:ENAB OFF

2.5 File

Displays a menu of functions that enable you to load, save, and manage data on either a floppy disk (A:) or the analyzer's internal drive (C:); you can recall, save, copy, delete, or rename files of instrument states, trace data, and screen captures. The menu keys display dialog boxes appropriate for the selected function.

Agilent analyzers use different types of mass storage devices:

- 3.5 inch disk drive (high density, 1.44 MBytes formatted) designated "A:" (Saving directly to drive A:\ can be slow. Try saving first to internal drive C:\ and then transferring the file.)
- Part of flash memory and treated as a device designated "C:"
- Part of flash memory and treated as a device for internal use only to store personality option firmware, designated "I:"

The MMEMOry command syntax term <'file_name'> is a specifier having the form: `\DRIVE:\DIRECTORY\NAME.EXT'`, where the following rules apply:

- "DRIVE" is "A:" or "C:"
- "\DIRECTORY\" is the path name.
- "NAME" is a DOS file name of up to eight characters, letters (A-Z, a-z) and numbers (0-9) only.
- "EXT" is an optional file extension using the same rules as "name," but consists of up to three characters total

File Types

You can save the following types of files:

- **State** - A file that contains a copy of the state of the analyzer at the time the file is saved. The settings of most analyzer functions are saved in the state files but not traces, limits, and corrections. When a **State** file is loaded into the analyzer, the analyzer is restored to the same state as when the file was saved. Some settings are not saved in the **State** files, for example the GPIB address; these settings are called "persistent." In this manual, each function describes whether that function is saved in "Instrument State" or is persistent.
- **Trace** - A file that contains a copy of the trace data for one or more traces. There are two formats for trace files, **Trace + State** and **CSV** files.

Trace + State: A file that contains the trace data and a copy of the current analyzer state. The trace and state are stored in an internal data format (TRC), which cannot be loaded into a PC, but can be loaded back into the analyzer. Traces can be loaded individually or as a group. When a Trace + State file is loaded into the analyzer the trace data that was on the screen, when saved, is loaded into the analyzer. This enables you to view the trace as it looked when it was saved. Because the state data is also saved, the analyzer settings, including all the annotation on the screen, is restored as well. To preserve the trace data, the traces contained in the saved files

are placed in View mode (see Trace/View, [page 283](#)) so that they are not immediately overwritten by new trace data. This means that you can save traces while making a measurement, and later load them back into the analyzer, where you can print them or transfer them to a computer, in CSV format, for analysis. If you wish to compare two saved traces, place traces in view mode before saving them. This prevents the trace from being rewritten based on a state change from subsequent loads.

CSV: A file that contains trace data in comma-separated values format (CSV, standard PC spreadsheet format), to be read into a spreadsheet for analysis. Most spreadsheet programs support CSV format. They cannot be loaded back into the analyzer.

- **Limits** - A file that contains a copy of the analyzer limit sets at the time the file is saved. Limits provide data sets to determine whether a trace has exceeded preset specifications. Limit sets can hold up to 200 points and can only be saved individually. Refer to the **File, Save, Source** key description, [page 142](#). When you load a **Limits** file into the analyzer, you restore all of the limit sets that were in the instrument at the time of the save.

NOTE When loading Limits files, be sure you have selected the appropriate X Axis Units: frequency or time (**Display, Limits, Properties, X Axis Units**). If you are in time X-Axis Units, and you load frequency limits, all current limit line data will be erased and the analyzer will switch to frequency units. The reverse of the this situation also holds true.

- **Screen** - A file that contains an exact representation of the analyzer display at the time it was saved. You cannot extract data from **Screen** files as you can with **Trace** files, but you can print them or include them in other documents; **Screen** files look exactly as the display looked when the file was saved. They cannot be loaded into the analyzer. There are four formats for screen files, **Bitmap, Metafile, Reverse Bitmap, and Reverse Metafile**.

Bitmap: A file that contains an exact bit representation of the screen. Stored in Graphics Interchange Format (GIF) format.

Metafile: A file that contains information about the objects on the screen. Stored in Windows Metafile Format (WMF) format, a format that can be read with Microsoft™ Word and Microsoft™ Excel, among others.

Reverse Bitmap: Same as **Bitmap**, but the black display backgrounds are changed to white and the yellow traces are turned to green to preserve printer black ink.

Reverse Metafile: Same as **Metafile**, but the black display backgrounds are changed to white and the yellow traces are turned to green to preserve printer black ink.

- **Corrections** - A file that contains a copy of the analyzer correction tables at the time the file is saved (CBL, ANT, OTH, AMP). Corrections provide a way to adjust the trace display for preset gain factors (such as for cable loss). A correction set can hold up to 200 points. Pressing **Corrections** activates the **Source** key. Refer to the **File, Save, Source** key description, [page 142](#). When you load a **Corrections** file into the analyzer, you restore all of the corrections values that were in the instrument at the time of the save.
- **Measurement Results**- A file that contains a copy of the analyzer measurement data that was current at the time the file is saved. Measurement results files are saved in.CSV format (for importing into spreadsheets). When you load a **Measurement Results** file into the analyzer, you restore all of the measurement data that was in the instrument at the time of the save.

2.5.1 Catalog

Displays directories and files located on the selected drive, depending upon the preferences set under the **Type** (page 131) and **Sort** (page 133) keys. **Catalog** displays menus to navigate the drives and to sort and select the files you wish to view.

NOTE The internal analyzer “drive” (C:\) is not an actual disk drive, but an area of nonvolatile (flash) memory which is presented as though it were a disk drive.

The internal analyzer “drive” (I:\) is used for instrument firmware and optional measurement personalities. It is not available for data/file storage.

Key Path: File

Remote Command:

```
:MMEMory:CATalog? <dir_name>
```

Remote Command Notes: Query returns all files in the specified drive \path name.

The return data will be in the format: <mem_used>, <mem_free>
{, <file_listing>}

Each <file_listing> indicates the name and size in bytes of one file in the directory list in the form: “<file_name>, <file_size>” for example, a file called “SCREN000.GIF” which is 21286 bytes in size, would list as “SCREN000.GIF, , 21286.” Directories are indicated by square brackets, for example “[MYDIR] , , .”

All files are listed, without regard to the preferences selected for the file catalog on the analyzer screen.

If you use lowercase characters, they are converted to uppercase in interpreting catalog commands.

Example: :MMEM:CAT? `C:\MYDIR\MYMEAS`

2.5.1.1 Type

Allows you to select the desired type of instrument-data files to be displayed. Common types of instrument data files include trace data, limit line data, and amplitude correction data. See “File Types” on page 127 for more information. The catalog displays all files (if **Type** is set to **All**) or files of the currently selected file type. All directories are always displayed.

Type	Format	Destination	Extension
State	State		STA
Trace	Trace + state	Trace 1, 2, 3, or all traces	TRC
	Comma separated trace values	Trace 1, 2, 3, or all traces	CSV
Limit	Internal data format		LIM
Screen	Bitmap		GIF
	Reverse bitmap		GIF
	Metafile		WMF
	Reverse metafile		WMF
Corrections	Internal data format		ANT, CBL, OTH, and AMP
Measurement Results	Comma separated values		CSV

Key Path: **File, Catalog**

State Saved: Type is not saved in the instrument state

Factory Preset: Type survives **Factory Preset** and *RST, but is set to **State** at power on.

Remote Command:

There is no remote command for this key.

2.5.1.1.1 All

Displays all files located in the selected directory. If selected, it applies to **Catalog**, **Delete**, **Copy**, and **Rename**.

Key Path: **File, Catalog, Type**

2.5.1.1.2 State

Displays all state files (STA) in the selected directory. State files contain most instrument settings. If selected, it applies to all **File** functions.

Key Path: **File, Catalog, Type**

2.5.1.1.3 Trace

Displays all trace files (TRC and CSV) in the selected directory. If selected, it applies to all File functions.

Key Path: File, Catalog, Type

2.5.1.1.4 Limits

Displays all limits files (LIM) in the selected directory.

Key Path: File, Catalog, Type

2.5.1.1.5 Screen

Displays all screen files (GIF and WMF) in the selected directory.

Key Path: File, Catalog, Type

2.5.1.1.6 Corrections

Displays all correction files (ANT, CBL, OTH, and AMP) in the selected directory.

2.5.1.2 Sort

Displays the **Sort** menu keys that enable you to view your saved files according to a selected file attribute. The selections include, **By Date**, **By Name**, **By Extension**, **By Size**, and **Order**. **Order (Up)** sorts files in ascending order (for example, A,B,C). **Order (Down)** sorts files in descending order (for example, C,B,A).

The **Sort** setting applies to all of the **File** functions, except **Save**.

Key Path: File, Catalog

State Saved: The Sort order survives Preset, but is not saved in the instrument state.

Remote Command:

There is no remote command for this key.

2.5.1.2.1 By Date

Sorts and displays the current file catalog by the date of the files.

Key Path: File, Catalog, Sort

2.5.1.2.2 By Name

Sorts and displays the current file catalog in alphabetical order of the name of the files.

Key Path: **File, Catalog, Sort**

2.5.1.2.3 By Extension

Sorts and displays the current file catalog, in alphabetical order, by the file extension of the file names (for example: .TRC, .STA).

Key Path: **File, Catalog, Sort**

2.5.1.2.4 By Size

Sorts and displays the current file catalog by the size of the files.

Key Path: **File, Catalog, Sort**

2.5.1.2.5 Order

Changes the order of the display of the current file catalog. **Up** sorts the files in ascending order (A to Z, 1 to 9), while **Down** sorts in descending order (Z to A, 9 to 1).

Key Path: **File, Catalog, Sort**

2.5.1.3 Dir Up

Moves up one subdirectory level within a directory. If your position is in the top level of the drive already, it moves up to the drive level and the current drive is highlighted (A: or C:).

Key Path: **File, Catalog**

2.5.1.4 Dir Select

Selects the drive or directory that is highlighted on the display. You can use the up and down arrows to select and highlight the desired drive or directory. If the top entry in the catalog has a “.” indication, you are in a subdirectory, and this key acts the same as the **Dir Up** key. When you are at the top directory level, this key moves up to the drive level.

Key Path: **File, Catalog**

2.5.2 Save

Displays menu keys that enable you to save files to the floppy (A:) or internal (C:) drive.

The menus allow you to fill in data-entry fields for file name, type, format, source, and path (directory). Some fields may be blank depending on file type.

The catalog list box is active and can be used for selecting the directory in which to save the file. Saved files that match the current **Type** and **Format** are shown. The **Sort Order** is always **Down, By Date**.

NOTE Never remove the floppy disk during a save operation. To do so could corrupt *all* data on the floppy disk.

Saving directly to floppy drive A:\ can be slow. Try saving first to internal drive C:\ and then transfer the file to the floppy drive.

NOTE Many errors can be generated by a bad **Save** operation. For this reason, if an 'Unable to Save file' message is seen, you should check the error queue (**System, Show Errors**) for the source of the error.

NOTE You can press the front-panel **Save** key to immediately save a file using an automatically generated file name. The current **Save** parameters will be used, as though **Save Now** had been pressed.

NOTE If saving a **Screen**, the screen saved is the screen that was displayed before pressing **File**. For this reason, the screens seen while in the **File** menus cannot be saved.

Key Path: **File**

Factory Preset: State is the default file type at power on.

2.5.2.1 Save Now

Executes the save function. While the file is being saved the popup message “Saving file” followed by “Reading directory” is displayed. After a successful save, the text message “xxxxxx file saved” (where xxxxxx is the file name) appears in the status line. Once you have used the **File, Save, Save Now** keys to setup and save a file, the **Save** hardkey will perform an immediate **Save Now** of your file in the same format and to the same location.

The analyzer will pick a filename for you based on the table below. The ### in the auto-generated file name represents a three-digit number which the analyzer has chosen to be the lowest number in the current sequence that does not conflict with an existing file name. The number starts at 000 with a new analyzer or after the installation of new firmware and counts up with each attempted **Save**. After a **Restore Sys Defaults**, the number will start at a number that may be lower than the lowest number of the file the currently saved files. The number counts up with each attempted **Save**, but will skip the numbers already in use and not over write existing files. If you want to enter your own file name, refer to **Name** (page 143) for additional information.

Type	Auto-Generated File Name	Extension
State	STATE###	.STA
Trace	TRACE###	.TRC or .CSV
Screen	SCREN###	.GIF or .WMF

NOTE Never remove the floppy disk during a save operation. To do so could corrupt *all* data on the floppy disk.

NOTE Many errors can be generated by a bad **Save** operation. For this reason, if an ‘Unable to Save file’ message is seen, you should check the error queue (**System, Show Errors**) for the source of the error.

NOTE You are always safe pressing **Save Now** without entering a file name, because the auto-generated file name never conflicts with an existing file.

If the Path: field above the directory box is empty when pressing **Save Now**, the status line will display the error message: Unable to save file, invalid path. In this case, please select a drive.

Key Path: File, Save

Remote Command:

```
:MMEMory:STORe:SCReen <'file_name'>  
:MMEMory:STORe:STATe 1,<'file_name'>  
:MMEMory:STORe:TRACe <label>,<'file_name'>
```

This command is not available when you are outside the Spectrum Analysis mode and working in optional measurement modes.

```
:MMEMory:STORe:LIMit LLINE1|LLINE2,<'file_name'>  
:MMEMory:STORe:CORRection ANTenna|CABLe|OTHer|USER,<'file_name'>  
:MMEMory:STORe:RESults <'file_name'>  
*SAV <register#>
```

Remote Command Notes: For the MMEM:STOR:TRAC <label>,<“file_name”> command:

Trace labels are: TRACE1|TRACE2|TRACE3|ALL
The file name must have a file extension of .TRC or .CSV. The file extension determines whether a trace is stored (.CSV), or a trace with its state (.TRC), are stored.

The <'file_name'> must include the complete path, for example 'C:\MYTRACE.TRC'. Lowercase characters are interpreted as uppercase.

These commands will fail if the <'file_name'> already exists.

For the MMEM:STOR:LIM LLINE2,“C:mylimit.lim” command, there is no short form for parameters LLINE1|LLINE2.

Example: MMEM:STOR:STAT 1, 'C:\mystate.sta' saves the current instrument state to the specified file name. The .sta extension is required.

*SAV saves the current instrument state to a file name REGxxx, where xxx = the register number. The available register numbers are 0 to 127.

MMEM:STOR:SCR 'C:\myscreen.gif' The file must have a .gif or .wmf file extension. The specified file extension determines which file format the instrument will use to save the image. Only **Bitmap** and **Metafile** are available (not **Reverse Bitmap** and **Reverse Metafile**).

MMEM:STOR:TRAC TRACE3, 'C:\mytrace.trc' Saves trace 3 to the trace + state file C:\MYTRACE.TRC

MMEM:STOR:CORR ANT, 'A:TEST1.AMP' saves the current antenna correction to the specified file name. The .amp extension is required.

MMEM:STOR:LIM LLINE2, 'C:mylimit.lim' saves the current limit line two data set to the specified file name. The .lim extension is required.

MMEM:STOR:RES 'A:ACP.CSV' saves the current ACP measurement results to the specified file name. The .csv extension is required.

2.5.2.2 Type

Allows you to select the type of data you want to save. The file types available for saving are described below. See “File Types” on page 127 and “Type” on page 131 for more information.

Type	Format	Source	Extension
State	State		STA
Trace	Trace + state	Trace 1, 2, 3, or all traces	TRC
	Comma separated trace values	Trace 1, 2, 3, or all traces	CSV
Limit	Internal data format		LIM
Screen	Bitmap		GIF
	Reverse bitmap		GIF
	Metafile		WMF
	Reverse metafile		WMF
Corrections	Internal data format		ANT, CBL, OTH, and AMP
Measurement Results	Comma separated values		CSV

NOTE All is not an option in **Save**, you have to specify the desired file type.

Key Path: **File, Save**

State Saved: Type is not saved in the instrument state

Factory Preset: Type survives **Factory Preset** and *RST, but is set to **State** at power on.

2.5.2.3 Format

When **Type** is set to **Trace**, **Format** allows you to choose between **Trace + State** and **CSV** formats. For more information on file types, refer to “File Types” on page 127.

When **Type** is set to **Screen**, **Format** allows you to choose between **Bitmap**, **Metafile**, **Reverse Bitmap**, and **Reverse Metafile** formats. For more information on file types, refer to “File Types” on page 127.

Key Path: **File, Save**

State Saved: **Format** is not saved in Instrument State.

Factory Preset: **Format** survives **Factory Preset** and *RST, but:

Trace file format is **Trace + State** at power on

Screen file format is **Bitmap** at power on

2.5.2.3.1 Trace + State

When the file type is **Trace**, this key selects the **Trace + State**, instrument-readable file (TRC) format for your file. For more information on file types, refer to [“File Types” on page 127](#).

Key Path: **File, Save, Format**

2.5.2.3.2 CSV

When the file type is **Trace**, this key selects the trace data as comma-separated values (CSV). The **CSV** format is readable by a spreadsheet on your computer, but the trace cannot be restored to the analyzer display. For more information on file types, refer to [“File Types” on page 127](#).

Key Path: **File, Save, Format**

2.5.2.3.3 Bitmap

When the file type is **Screen**, this key selects the bitmap Graphics Interchange Format (GIF) file format for your saved data. For more information on file types, refer to [“File Types” on page 127](#).

Key Path: **File, Save, Format**

2.5.2.3.4 Metafile

When the file type is **Screen**, this key selects the metafile Windows Metafile Format (WMF) file format for your saved data. For more information on file types, refer to [“File Types” on page 127](#).

Key Path: **File, Save, Format**

2.5.2.3.5 Reverse Bitmap

When the file type is **Screen**, this key selects the inverse bitmap file format (GIF) for your saved data. For more information on file types, refer to [“File Types” on page 127](#).

Key Path: **File, Save, Format**

2.5.2.3.6 Reverse Metafile

When the file type is **Screen**, this key selects the inverse metafile file format (WMF) for your saved data. For more information on file types, refer to [“File Types” on page 127](#).

Key Path: **File, Save, Format**

2.5.2.4 Source

When the file type is set to **Trace**, this key allows you to save trace **1, 2, 3** or **All**. Saving trace **All** saves all traces in a single .TRC file.

When the file type is set to **Corrections**, **Source** accesses the **Antenna, Cable, Other** and **User** menu keys, which allow you to select the type of correction to be saved.

When the file type is set to **Limits**, **Source** accesses the **Limit 1** and **Limit 2** menu keys. **Limit 1** and **Limit 2** provide data sets to determine whether a trace has exceeded preset specifications. Limit sets can hold up to 200 points and can only be saved individually.

For any other Save type, **Source** is disabled (greyed out).

Key Path: **File, Save**

State Saved: **Source** is not saved in Instrument State.

Factory Preset: **Source** survives **Factory Preset** and *RST, but is set to **All Traces** at power up.

2.5.2.4.1 Trace 1

Selects trace 1 to be saved.

Key Path: **File, Save, Source**

2.5.2.4.2 Trace 2

Selects trace 2 to be saved.

Key Path: **File, Save, Source**

2.5.2.4.3 Trace 3

Selects trace 3 to be saved.

Key Path: **File, Save, Source**

2.5.2.4.4 All Traces

Selects all the traces to be saved.

Key Path: **File, Save, Source**

2.5.2.5 Name

Displays the Alpha Editor and enables you to enter a filename. The numeric keypad can also be used while entering file names. Press **Enter** or **Return** to complete the name entry.

NOTE Only capital letters (A-Z) and digits (0-9) may appear in file names (8 characters, maximum). Additionally, file names include a 3 digit extension which is automatically set by the instrument depending on the file type and format.

Key Path: File, Save

Remote Command:

The file name is entered as part of the directory/path name that is sent with the SCPI command. See [“Save Now” on page 137](#).

2.5.2.6 Dir Up

Moves up one subdirectory level within a directory. If your position is in the top level of the drive already, it moves up to the drive level and the current drive is highlighted (A: or C:).

Key Path: File, Save

Remote Command:

The directory is entered as part of the directory/path name that is sent with the SCPI command. See [“Save Now” on page 137](#).

2.5.2.7 Dir Select

Displays the highlighted directory. See [“Dir Select” on page 135](#) for more information.

Key Path: File, Save

Remote Command:

The directory is entered as part of the directory/path name that is sent with the SCPI command. See [“Save Now” on page 137](#).

2.5.3 Load

Displays the menu key that enables you to load instrument-data files from the selected drive and directory back into the instrument. This function displays the file list box, which shows the data-entry fields for the file name, type, destination, and path.

The catalog list box is active and can be used for selecting the file information in the data-entry fields. Only loadable files that match the current type are shown. Placing the

cursor on a file name causes it to be loaded into the file name field.

Key Path: **File**

2.5.3.1 Load Now

Loads the currently selected file. Displayed settings include name, type, destination, and path. While the file is being loaded a popup message is displayed “Loading file.” After a successful load, the text message “xxxxxxx file loaded” (where xxxxxx is the file name) appears in the status line. When traces are loaded they always load in **View** mode.

Traces save in TRC format can be loaded individually or as a group. When a trace is loaded, the state that existed when that trace was saved is loaded along with the trace. Also, the loaded trace(s) is/are placed in view mode.

NOTE To compare two saved traces from different saves, place traces in view mode before saving them. This prevents the trace from being rewritten based on a state change from subsequent loads.

Key Path: File, Load

Remote Command:

:MMEMory:LOAD:STATE 1,<'file_name'> loads the specified state file into the current active state of the instrument.

*RCL <register#> loads the state from the specified internal register into the current active state of the instrument. The available register numbers are 0 to 127.

:MMEMory:LOAD:TRACe <label>,<'file_name'>

:MMEMory:LOAD:CORRection ANTenna|CABLe|OTHer|USER,<'file_name'>

:MMEMory:LOAD:LIMit LLINE1|LLINE2,<'file_name'>

Remote Command Notes: For the MMEM:LOAD:TRAC <'file_name'> command, <'file_name'> must include the following:

- Complete path
- A file extension of TRC
- Use all uppercase letters.
- Trace labels are: TRACE1 | TRACE2 | TRACE3

For the MMEM:LOAD:STAT 1 command:

- If the firmware revision of the state being loaded is newer than the firmware revision of the instrument, no state is recalled and an error is reported.
- If the firmware revision of the state being loaded is the same as the firmware revision of the instrument, all settings of the state will be loaded.

- If the firmware revision of the state being loaded is older than the firmware revision of the instrument, the instrument will only load the older settings of the state.

Example:

```
MMEM:LOAD:STAT 1, 'C:MYSTATE.STA' loads the state file  
C:\MYSTATE.STA.
```

```
MMEM:LOAD:TRAC TRACE3, 'C:MYTRACE.TRC' loads the trace in file  
C:\MYTRACE.TRC into trace 3.
```

2.5.3.2 Type

Enables you to select the type of file you want to load. See “File Types” on page 127 and “Type” on page 131 for more information.

The file types available for loading are described in the following table:

Type	Format	Destination	Extension
State	State		STA
Trace	Trace + state	Trace 1, 2, 3, or all traces	TRC
	Comma separated trace values	Trace 1, 2, 3, or all traces	CSV
Limit	Internal data format		LIM
Corrections	Internal data format		ANT, CBL, OTH, and AMP

NOTE All is not a file type option in **Load**, you have to specify the desired file type.

Key Path: **File, Load**

2.5.3.3 Sort

Allows you to view saved files according to a selected file attribute. See “Sort” on page 133 for more information.

Key Path: **File, Load**

2.5.3.4 Destination

When **Type** is set to **Trace**, **Destination** allows you to direct your data to **Trace 1**, **Trace 2**, or **Trace 3** for a single-trace file. If the data is for all three traces (**Source** was **All** when they were saved), the data will be returned to the original trace registers, regardless of the **Destination** setting.

When **Type** is set to **Limits**, **Destination** allows you to direct your data to **Limit 1** or **Limit 2**.

Key Path: **File, Load**

State Saved: Not saved in Instrument State.

Factory Preset: Trace file format, is All Traces at power on.

2.5.3.4.1 Trace 1

Selects trace 1 for the trace data to be loaded into.

Key Path: **File, Load, Destination**

State Saved: Not saved in Instrument State.

Factory Preset: Not affected by **Preset**. Power up and **Restore Sys Defaults** sets **Trace 1**.

2.5.3.4.2 Trace 2

Selects trace 2 for the trace data to be loaded into.

Key Path: **File, Load, Destination**

State Saved: Not saved in Instrument State.

Factory Preset: Not affected by **Preset**. Power up and **Restore Sys Defaults** sets **Trace 1**.

2.5.3.4.3 Trace 3

Selects trace 3 for the trace data to be loaded into.

Key Path: **File, Load, Destination**

State Saved: Not saved in Instrument State.

Factory Preset: Not affected by **Preset**. Power up and **Restore Sys Defaults** sets **Trace 1**.

2.5.3.5 Dir Up

Moves up one subdirectory level within a directory. If your position is in the top level of the drive already, it moves up to the drive level and the current drive is highlighted (A: or C:).

Key Path: **File, Load**

State Saved: Not saved in Instrument State.

Factory Preset: Trace file format, is All Traces at power on.

2.5.3.6 Dir Select

Displays the highlighted directory. See [“Dir Select” on page 135](#) for more information.

Key Path: **File, Load**

State Saved: Not saved in Instrument State.

Factory Preset: Trace file format, is All Traces at power on.

2.5.4 Delete

Displays the **Delete** menu keys that enable you to delete instrument data files from the selected directory. The catalog list box is active and can be used for selecting file information for the data-entry fields. Only files that match the current type are shown.

Placing the cursor on a file name causes it to be loaded into the file name field.

Key Path: **File**

2.5.4.1 Delete Now

Executes the delete function. After you select the file or directory you want to delete, press **Delete Now** to perform the delete. While the file is being deleted, the popup message “Deleting file” followed by “Reading directory” are displayed. After a successful deletion, the text message “xxxxxx file deleted” (where xxxxxx is the file name) appears in the status line.

If you select a directory or subdirectory to delete, the following popup message is displayed “WARNING: You are about to delete all of the contents of directory xxxxxx. Press Delete Now again to proceed or any other key to abort.” (xxxxxx is the full path and directory name).

To quickly delete all of the file in a directory, select the file at the top of the list and press **Delete Now** repeatedly until all the files are deleted.

Key Path: File, Delete

Remote Command:

:MMEMory:DELeTe <'file_name'> deletes a file.

:MMEMory:RDIRectory <'directory_name'> deletes a directory.

Remote Command Notes: If <'file_name'> does not exist, a “File Name Error” occurs.

<'file_name'> and <'directory_name'> must include the complete path. Lowercase characters are read as uppercase.

Example: MMEM:DEL 'C:\destinat.trc' removes the file C:\DESTINAT.TRC.

MMEM:RDIR 'C:\myDir' removes directory C:\MYDIR and all files and subdirectories within that directory.

2.5.4.2 Type

Allows you to select the type of file you want to delete. See “File Types” on page 127 and “Type” on page 131 for more information.

Allows you to select the type of files to be displayed for you to delete. Common types of instrument data files include trace data, limit line data, and amplitude correction data. The catalog displays all files, if **Type** is set to **All** or files of the currently selected file type. All directories are always displayed.

Key Path: File, Delete

2.5.4.3 Sort

Allows you to view your saved files according to a selected file attribute. See “Sort” on page 133 for more information.

Key Path: File, Delete

2.5.4.4 Dir Up

Moves up one subdirectory level within a directory. If your position is in the top level of the drive already, it moves up to the drive level and the current drive is highlighted (A: or C:).

Key Path: **File, Delete**

2.5.4.5 Dir Select

Displays the highlighted directory. See “Dir Select” on page 135 for more information.

Key Path: **File, Delete**

2.5.5 Copy

Displays the functions to copy instrument data files in the selected directory to the directory and file name that you choose. This key also displays a catalog of the files that are currently saved in the selected directory and data-entry fields for the following: file name, type, and path location.

Key Path: **File**

2.5.5.1 Copy Now

Executes the copy function, copying data files from one directory to another on one or more mass storage devices, using the currently displayed file settings. While the file is being copied, the “Copying file” followed by “Reading directory” popup message is displayed. After a successful copy, the green text message “xxxxxxx file copied” (where xxxxxx is the file name) appears in the status line. If a copy is being done for a file that already exists in the “To” directory, the text message “File already exists” appears in the status line.

Key Path: File, Copy

Remote Command:

```
:MMEMory:COPY <'file_name1'>,<'file_name2'>
```

Remote Command Notes: The file names must include the complete file paths. Lowercase characters are read as uppercase.

The original file is <“file_name1”>, and the new copy of the file is <“file_name2”>.

Example: :MMEM:COPY 'C:\oldname.sta', 'A:\newname.sta' copies
 C:\OLDNAME.STA to A:\NEWNAME.STA.

2.5.5.2 Type

Enables you to select the type of file you want to copy. See “File Types” on page 127 and “Type” on page 131 for more information. If **Type** is set to **All**, the catalog displays all files, otherwise the files of the currently selected file type are displayed. All directories are always displayed.

Type	Format	Extension
State	State	STA
Trace	Trace + state	TRC
	Comma separated trace values	CSV
Limit	Internal data format	LIM
Screen	Bitmap	GIF
	Reverse bitmap	GIF
	Metafile	WMF
	Reverse metafile	WMF
Corrections	Internal data format	ANT, CBL, OTH, and AMP
Measurement Results	Comma separated values	CSV

Key Path: **File, Copy**

2.5.5.3 Sort

Allows you to view your saved files according to a selected file attribute. See “Sort” on page 133 for more information.

Key Path: **File, Copy**

2.5.5.4 Dir From/To

Allows you to select the source and destination directories for your copy on one or more drives. When you press **Dir From/To**, it toggles between the two displayed directory list windows. Allowing you to define the “From” and “To” locations for copying.

Key Path: **File, Copy**

State Saved: Powers up with C:\ as both the “From” and “To” drives. Not save in state. Survives **Factory Preset**.

2.5.5.5 Dir Up

Moves up one subdirectory level within a directory. If your position is in the top level of the drive already, it moves up to the drive level and the current drive is highlighted (A: or C:).

Key Path: **File, Copy**

2.5.5.6 Dir Select

Displays the highlighted directory. See “Dir Select” on page 135 for more information.

Key Path: **File, Copy**

2.5.6 Rename

Allows you to rename a file. The catalog list box is active and can be used for selecting both the path and a file name. Only loadable files that match the current type are shown. Placing the cursor on a file name causes it to be loaded into the file name field.

Key Path: **File**

2.5.6.1 Rename Now

Executes the rename function. When the rename is complete, the message `XXXXXX file renamed to YYYYYY` (where `XXXXXX` and `YYYYYY` are the filenames) will appear in the status line on your display. If you try to rename a file with a name that already exists, the text message (`File already exists`) appears in the status line. Placing the cursor on a file name causes it to be loaded into the file name field.

Key Path: File, Rename

Remote Command:

```
:MMEMory:MOVE <'file_name1'>,<'file_name2'>
```

Remote Command Notes: `<'file_name1'>` must include the complete path, and the case *must* match that of the file to be renamed. `<'file_name2'>` must contain the complete path of the destination, and the case of any directories in the path *must* match those of the directories in the destination path. The case of the destination file name is always interpreted as uppercase.

You can use this command to move files between directories and drives, even though there is no way to do this from the front panel.

Example: MMEM:MOVE 'C:\STATE001.STA' , 'C:\FREQ.STA'

2.5.6.2 Type

Enables you to select the type of file you want to rename. See “File Types” on page 127 and “Type” on page 131 for more information.

If **Type** is set to **All**, the catalog displays all files, otherwise the files of the currently selected file type are displayed. All directories are always displayed.

Type	Format	Extension
State	State	STA
Trace	Trace + state	TRC
	Comma separated trace values	CSV
Limit	Internal data format	LIM
Screen	Bitmap	GIF
	Reverse bitmap	GIF
	Metafile	WMF
	Reverse metafile	WMF
Corrections	Internal data format	ANT, CBL, OTH, and AMP
Measurement Results	Comma separated values	CSV

Key Path: **File, Rename**

2.5.6.3 Sort

Allows you to view your saved files according to a selected file attribute. See “Sort” on page 133 for more information.

Key Path: **File, Rename**

2.5.6.4 Name

Displays the Alpha Editor and enables you to enter the file name you want to rename the file to. The numeric keypad can also be used to enter a filename while the alpha editor is accessed. Complete your entry by pressing **Return** or **Enter**. See “Name” on page 143 for more information.

NOTE Only capital letters (A-Z) and digits (0-9) may appear in file names (8 characters, maximum). Additionally, file names include a 3 digit extension which is automatically set by the instrument.

Key Path: **File, Rename**

2.5.6.5 Dir Up

Moves up one subdirectory level within a directory. If your position is in the top level of the drive already, it moves up to the drive level and the current drive is highlighted (A: or C:).

Key Path: **File, Rename**

2.5.6.6 Dir Select

Displays the highlighted directory. See “Dir Select” on page 135 for more information.

Key Path: **File, Rename**

2.5.7 Create Dir

Displays the functions to create a new subdirectory in the currently selected directory.

Key Path: File

2.5.7.1 Create Dir Now

Executes the create a new directory function. While the directory is being created a popup message is displayed “Creating directory” followed by “Reading directory.” After the successful creation of a directory, the text message “Directory xxxxxx created” (where xxxxxx is the new directory name) appears in the status line. If the creation of a new directory is being performed for a directory name that already exists, the text message “Directory already exists” appears in the status line.

Key Path: File, Create Dir

Remote Command:

```
:MMEMory:MDIRectory <'dir_name'>
```

Remote Command Notes: <'dir_name'> must contain the complete path for the new directory. Lowercase characters are interpreted as uppercase.

Example: MMEM:MDIR 'C:\myDir' creates directory MYDIR on the C:\ drive.

2.5.7.2 Name

Displays the Alpha Editor and enables you to enter a directory name. The numeric keypad can also be used to enter a directory name while the alpha editor is accessed. To complete the entry, press **Return** or **Enter**.

NOTE Only capital letters (A-Z) and digits (0-9) may appear in directory names (8 characters, maximum).

Key Path: **File, Create Dir**

2.5.7.3 Dir Up

Moves up one subdirectory level within a directory. If your position is in the top level of the drive already, it moves up to the drive level and the current drive is highlighted (A: or C:).

Key Path: **File, Create Dir**

2.5.7.4 Dir Select

Displays the highlighted directory. See “Dir Select” on page 135 for more information.

Key Path: **File, Create Dir**

2.5.8 Delete All

Deletes all the files on a floppy disk; any information on the disk will be destroyed.

Key Type: Branch

Key Notes: This key displays the file manager display form which includes data entry fields for the new drive name and path.

There is another definition of Format key that defines the format (file type) of you data that you want to save.

Remote Command:

There is no remote command for this key.

2.5.8.1 Delete All Now

Executes the **Delete All** function. After pressing **Delete All**, the following message will appear on the display: `WARNING: You are about to destroy ALL data on volume A: Press Delete All again to proceed or any other key to abort.` While deleting, a popup message is displayed “Deleting All.” After a successful floppy disk file deletion, the green text message “Volume A: delete complete”, appears in the status line.

Key Path: **File, Delete All**

Remote Command:

There is no remote command for this key.

2.5.9 Query Trace Data (Remote Command Only)

This command queries trace data from the specified trace. The data format is set by the command `:FORMat [:TRACe] [:DATA]`. When ASCII format is selected, the data is comma-separated ASCII values. Real or Integer format uses a definite length block of data.

The number of trace points returned is set by `[:SENSE] :SWE:POIN` (from 101 to 8192).

Remote Command:

```
:TRACe [:DATA] ? TRACE1 | TRACE2 | TRACE3 | LLINE1 | LLINE2
```

Remote Command Notes: Commands `:MMEM:STOR:TRAC` and `:MMEM:LOAD:TRAC` are used to transfer trace data to, or from, the internal hard drive or floppy drive of the instrument.

The query returns the current values of the designated trace. The data is terminated with `<NL><END>` (for GPIB that is newline, or linefeed, followed by EOI set true; for RS-232 this is newline only.)

Example: `:TRAC:DATA? TRACE1`

2.5.10 Move Data to a File (Remote Command Only)

This command loads a block of data in the format `<definite_length_block>` into the instrument memory location `<'file_name'>`. The query form of the command returns the contents of the file identified by `<'file_name'>`, in the format of a definite length block of data. The query can be used for copying files out of the analyzer over the remote bus.

A definite length block of data starts with an ASCII header that begins with # and indicates how many additional data points are following in the block. Suppose the header is #512320.

- The first digit in the header (5) tells you how many additional digits/bytes there are in the header.
- The 12320 means 12,320 data bytes follow the header.
- Divide this number of bytes by your selected data format bytes/point, either 8 (for real 64), or 4 (for real 32). In this example, if you are using real 64 then there are 1540 points in the block.

Remote Command:

```
:MMEMory:DATA <'file_name'>, <definite_length_block>
```

```
:MMEMory:DATA? <'file_name'>
```

Example: `MMEM:DATA 'C:\DEST.TXT', '#14abcd'` Loads the data “abcd” into `C:\DEST.TXT`.

`MMEM:DATA? 'C:\SCREEN001.GIF'` Initiates a transfer of data from file `C:\SCREEN001.GIF`.

2.5.11 Set Data Byte Order (Remote Command Only)

This command selects the binary data byte order for data transfer. It controls whether binary data is transferred in normal or swapped mode. Normal mode is when the byte sequence begins with the most significant byte (MSB) first, and ends with the least significant byte (LSB) last in the sequence: 1 | 2 | 3 | 4. Swapped mode is when the byte sequence begins with the LSB first, and ends with the MSB last in the sequence: 4 | 3 | 2 | 1.

State Saved: Survives **Preset** but not power cycle. Not saved in Instrument State.

Factory Preset: Normal

Remote Command:

:FORMat:BORDER Normal|SWAPped

:FORMat:BORDER?

Example: FORM:BORD SWAP

2.5.12 Format Numeric Data (Remote Command Only)

This command changes the format of the data. It specifies the format used for trace data during data transfer across any remote port. REAL and ASCII formats will format trace data in the current amplitude units. The format of state data cannot be changed. It is always in a machine readable format only.

NOTE One-button measurement functions only support Binary Real 32, Binary Real 64, and ASCII data formats.

When in Spectrum Analysis mode using older instrument firmware, you were only allowed to change the format of trace type data that was returned using TRACe[:DATA]. With this old firmware, other types of measurement data was only available in the ASCII format. (That is, data returned using FETCh, MEASure and READ commands while in Signal Analysis mode.)

For corrected trace data (:TRACe[:DATA] with parameter <trace_name>), REAL and ASCII formats will provide trace data in the current amplitude units. INTEger format will provide trace data in mdBm. The fastest mode is INTEger,32. However, some measurement data will not fit in 32-bit integers.

ASCII - Amplitude values are in amplitude units separated by commas. ASCII format requires more memory than the binary formats. Handling large amounts of this type of data, takes more time and storage space.

Integer,32 - Binary 32-bit integer values in internal units (dBm), in a definite length block.

Real,32 (or 64) - Binary 32-bit (or 64-bit) real values in amplitude units, in a finite length block. Transfers of real data are done in a binary block format.

A definite length block of data starts with an ASCII header that begins with # and indicates how many additional data points are following in the block. Suppose the header is #512320:

- The first digit in the header (5) tells you how many additional digits/bytes there are in the header.
- The 12320 means that 12,320 data bytes follow the header.
- Divide this number of bytes by your selected data format bytes/point, either 8 (for real 64), or 4 (for real 32). In this example, if you are using real 64 then there are 1540 data points in the block.

State Saved: Saved in Instrument State.

Factory Preset: Survives Preset but not power cycle. Powers up in ASCII format.

Remote Command:

```
:FORMat [:TRACe] [:DATA] ASCii | INTeger, 32 | REAL, 32 | REAL, 64 | UINTegeR, 16
```

```
:FORMat [:TRACe] [:DATA] ?
```

Remote Command Notes:

Corrected Trace Data Types for :TRACe:DATA?<trace_name>	
Data Type	Result
ASCii	Amplitude Units
UINTegeR,32 (fastest)	Internal Units
REAL,32	Amplitude Units
REAL,64	Amplitude Units

Example: FORM REAL, 32

2.6 FREQUENCY / Channel

Displays the menu of frequency functions. Depending on the **Frequency** entry mode, either the center frequency or the start and stop frequency values appear below the graticule on the display. In Center/Span mode, the **Center Frequency** and **Span** appear, and the **Center Freq** function is automatically activated. In Start/Stop mode, the **Start** and **Stop** frequencies appear, and the **Start Freq** function is automatically activated.

NOTE Although the analyzer allows entry of frequencies greater than its specified range, analyzer performance will be degraded if it is used beyond the specified frequency range.

2.6.1 Center Freq

Activates the function that sets the center of the displayed frequency range to the specified frequency.

Key Path: **FREQUENCY**

Annunciation/

Annotation: Center <value> appears in the lower left corner of the display.

Dependencies/

Couplings: Center frequency and span are coupled to each other.

State Saved: Saved in instrument state.

Factory Preset:

Model	Center Frequency
E4440A	13.255 GHz
E4443A	3.355 GHz
E4445A	6.605 GHz
E4446A	22.005 GHz
E4448A	25.005 GHz

Range:

Model	Frequency Range (with Frequency Offset = 0 Hz)		
E4440A	-100.0 MHz	to	26.0 GHz
E4443A	-100.0 MHz	to	7.2 GHz
E4445A	-100.0 MHz	to	13.7 GHz
E4446A	-100.0 MHz	to	44.5 GHz
E4448A	-100.0 MHz	to	51.0 GHz

Remote Command:

[:SENSe] :FREQuency:CENTer <frequency> | UP | DOWN

[:SENSe] :FREQuency:CENTer?

Example: `FREQ:CENT 5 GHz` sets the center frequency to 5 GHz
 `FREQ:CENT UP` changes the center frequency to 5.1 GHz if you use
 `FREQ:CENT:STEP 100 MHz` to set the center frequency step size to 100 MHz
 `FREQ:CENT?`

2.6.2 Start Freq

Sets the frequency at the left side of the graticule and sets the frequency entry mode to Start/Stop. When the Start/Stop Frequency entry mode is activate, the start and stop frequency values are displayed below the graticule in place of center frequency and span. The left and right sides of the graticule correspond to the start and stop frequencies.

When **Start Freq** reaches the upper frequency limit, the stop frequency is set to the highest available frequency and the start frequency is changed to be less then the stop frequency by the minimum span (10 Hz). **Center Freq** will be updated to the stop frequency minus one-half of the span, or to the stop frequency minus 5 Hz, and **Res BW** and **VBW** will be set to 1 Hz.

Key Path: **FREQUENCY**

Dependencies/

Couplings: Start Freq is unavailable when Segmented sweep is on.

State Saved: Saved in Instrument State

Factory Preset: 10 MHz

Range:

Model	Frequency Range		
E4440A	-100.0000000 MHz	to	26.99999999 GHz
E4443A	-100.0000000 MHz	to	7.19999999 GHz
E4445A	-100.0000000 MHz	to	13.69999999 GHz
E4446A	-100.0000000 MHz	to	44.49999999 GHz
E4448A	-100.0000000 MHz	to	50.99999999 GHz

Remote Command:

[:SENSe] :FREQuency:STARt <freq>

[:SENSe] :FREQuency:STARt?

Example: FREQ:STAR 200 MHz

 FREQ:STAR?

2.6.3 Stop Freq

Sets the frequency at the right side of the graticule and sets the frequency entry mode to Start/Stop. When the Start/Stop Frequency entry mode is activate, the start and stop frequency values are displayed below the graticule in place of center frequency and span. The left and right sides of the graticule correspond to the start and stop frequencies.

Key Path: **FREQUENCY**

State Saved: Saved in Instrument State

Factory Preset:

Model	Stop Frequency
E4440A	26.50000000 GHz
E4443A	6.70000000 GHz
E4445A	13.20000000 GHz
E4446A	44.00000000 GHz
E4448A	50.00000000 GHz

Range:

Model	Frequency Range		
E4440A	-100.000000 MHz	to	27.0 GHz
E4443A	-100.000000 MHz	to	13.7 GHz
E4445A	-100.000000 MHz	to	7.2 GHz
E4446A	-100.000000 MHz	to	44.5 GHz
E4448A	-100.000000 MHz	to	51.0 GHz

Remote Command:

[:SENSe] :FREQuency:STOP <frequency>

[:SENSe] :FREQuency:STOP?

Example: FREQ:STOP 1600

 FREQ:STOP?

2.6.4 CF Step

Changes the step size for the center frequency and start/stop frequency functions. Once a step size has been selected and the center frequency function is activated, the step keys (and the UP|DOWN parameters for Center Frequency from remote commands) change center frequency by the step-size value. The step size function is useful for finding harmonics and sidebands beyond the current frequency span of the analyzer. When auto-coupled in a non-zero span, the center frequency step size is set to 10% of the span.

Key Path: **FREQUENCY**

State Saved: Saved in Instrument State

Factory Preset: Span/10

Knob

Increment:

if Span = 0 Hz increment = RBW/20
if Span > 0 Hz increment = Span/200

Step Key

Increment:

if CF Step = auto, Span = 0 Hz step = RBW
if CF Step = auto, Span > 0 Hz step = Span/10
if CF Step = manual step = 1, 2, 5 sequence

Range:

Model	Minimum	Maximum
E4440A	1 Hz	27.0 GHz
E4443A	1 Hz	7.2 GHz
E4445A	1 Hz	13.7 GHz
E4446A	1 Hz	44.5 GHz
E4448A	1 Hz	51.0 GHz

Remote Command:

[:SENSe] :FREQUency:CENTer:STEP[:INCRement] <freq>

[:SENSe] :FREQUency:CENTer:STEP[:INCRement] ?

[:SENSe] :FREQUency:CENTer:STEP:AUTO OFF | ON | 0 | 1

[:SENSe] :FREQUency:CENTer:STEP:AUTO?

Example: FREQ:CENT:STEP:AUTO ON
 FREQ:CENT:STEP 500 MHz
 FREQ:CENT UP increases the current center frequency value by 500 MHz
 FREQ:CENT:STEP?
 FREQ:CENT:STEP:AUTO?

2.6.5 Freq Offset

Enables you to input a frequency offset value to account for frequency conversions external to the analyzer. This value is added to the display readout of the marker frequency, center frequency, start frequency, stop frequency and all other absolute frequency settings in the analyzer. When a frequency offset is entered, the value appears below the center of the graticule. Offsets may only be entered using the numeric keypad, not the knob or step keys. To eliminate an offset, perform a Factory Preset or set the frequency offset to 0 Hz.

This command does not affect any bandwidths or the settings of relative frequency parameters such as delta markers or span. It does not affect the current hardware settings of the analyzer, but only the displayed frequency values. Offsets are not added to the frequency count readouts. Entering an offset does not affect the trace display.

Key Path: **FREQUENCY**

Dependencies/

Couplings: Frequency offset is not available when segmented sweep is on or when frequency scale type is set to log (i.e. Log Sweep is on).

State Saved: Saved in Instrument State

Factory Preset: 0 Hz

Range: -500 THz to 500 THz

Remote Command:

[:SENSe] :FREQuency:OFFSet <freq>

[:SENSe] :FREQuency:OFFSet?

Example: FREQ:OFFS 10 MHz

2.6.6 Signal Track

When a marker is placed on a signal and **Signal Track** is pressed, the marker will remain on the signal while the analyzer retunes the center frequency to the marker frequency. The analyzer will keep the signal at the center of the display, as long as the amplitude of the signal does not change by more than 3 dB from one sweep to another. If no marker is active, pressing **Signal Track** to **On** will activate a marker, perform a peak search, and center the marker on the display.

If the signal is lost, an attempt will be made to find it again and continue tracking. If there are other signals on screen near the same amplitude, one of them may be found instead. Signals near 0 Hz cannot be tracked effectively as they cannot be distinguished from the LO feedthrough, which is excluded by intent from the search algorithm.

When **Signal Track** is **On** and the span is reduced, an automatic zoom is performed and the span is reduced in steps so that the signal remains at the center of the display. If the span is zero, signal track cannot be activated.

NOTE This function is intended to track signals with a frequency that is changing (drifting), and an amplitude that is not changing. It keeps tracking if in continuous-sweep mode. If in single-sweep mode, the analyzer only does one center frequency adjustment as necessary.

Signal tracking can also be used with the Δ (delta) pair marker function. This could be used to measure the amplitude at a frequency offset, relative to the fundamental signal amplitude, even if the fundamental is drifting. In this situation, the “tracking” function will be done on the delta marker, not on the reference marker. So you would want to put the ref marker on the frequency+offset, and put the Δ marker on the fundamental signal peak. Then turn on signal tracking. The frequency difference between the two markers will stay fixed. The Δ marker, on the fundamental, will track to the center of the display. The marker readout value will show the amplitude delta between the two markers.

Key Path: **FREQUENCY**

Annunciation/

Annotation: ST appears near the lower-left corner of the display. An (*) may appear in the upper-right corner of the display while the analyzer whenever the analyzer finds that it must retune in order to center the signal on the

display.

Dependencies/

Couplings: Signal Track is turned off when you do any of the following:

1. **Preset** is pressed (with Preset Type set to Factory),
2. **Markers All Off** is pressed.

Signal Track is not available when any of the following is true:

1. Signal ID = on
2. Span = 0 Hz
3. Frequency scale type = Log
4. Segmented sweep = on

The following features are not available when Signal Track is on:

1. Signal ID
2. Segmented sweep
3. Log sweep

State Saved: Saved in instrument state.

Factory Preset: Off

Remote Command:

```
:CALCulate:MARKer[1] | 2 | 3 | 4:TRCKing[:STATe] OFF|ON|0|1
```

```
:CALCulate:MARKer[1] | 2 | 3 | 4:TRCKing[:STATe] ?
```

Example: CALC:MARK1:TRCK ON turns on **Signal Track** using Marker 1.

```
CALC:MARK1:TRCK?.
```

2.7 Input/Output

Displays the keys that control some of the signal inputs and outputs of the analyzer.

2.7.1 Input Port

Brings up a menu of input signal sources, the most common one being the front panel RF Input port.

Key Path: **Input/Output**

State Saved: Saved in Instrument State

Factory Preset: RF

Remote Command:

```
[ :SENSe ] :FEED RF | AREFERENCE | EMIXer
```

```
[ :SENSe ] :FEED?
```

Example: FEED AREF selects the 50 MHz amplitude reference as the signal input.

2.7.1.1 RF

Selects the front panel RF Input port to be the analyzer signal input.

Key Path: **Input/Output, Input Port**

Remote Command:

See [“Input Port” on page 171](#)

Example: FEED AREF selects the 50 MHz amplitude reference as the signal input.

2.7.1.2 Amptd Ref

Selects the 50 MHz, -25 dBm internal amplitude reference as the input signal.

Key Path: **Input/Output, Input Port**

Remote Command:

See [“Input Port” on page 171](#)

Example: FEED AREF selects the 50 MHz amplitude reference as the signal input.

2.7.2 RF Coupling

Specifies alternating current (AC) or direct current (DC) coupling at the analyzer RF input port. Selecting AC coupling switches in a blocking capacitor that blocks any DC voltage present at the analyzer input. This decreases the input frequency range of the analyzer, but prevents damage to the input circuitry of the analyzer if there is a DC voltage present at the RF input.

In AC coupling mode, signals less than 20 MHz are not calibrated. You must switch to DC coupling to see calibrated frequencies of less than 20 MHz. Note that the message DC Coupled will be displayed on the analyzer when DC is selected.

Some amplitude specifications apply only when coupling is set to DC. Refer to the appropriate amplitude specifications and characteristics for your analyzer.

CAUTION When operating in DC coupled mode, ensure protection of the input mixer by limiting the input level to within 200 mV of 0 Vdc. In AC or DC coupling, limit the input RF power to +30 dBm.

Key Path: **Input/Output**

Dependencies/

Couplings: Not available on 40 GHz or 50 GHz analyzers.

State Saved: Saved in Instrument State

Factory Preset: AC

Remote Command:

```
:INPut:COUPling AC|DC
```

```
:INPut:COUPling?
```

Example: INP:COUP DC

2.7.3 Input Z Corr

Sets the input impedance for voltage-to-power conversions. The impedance you select is for computational purposes only, since the actual impedance is set by internal hardware to 50 ohm. The default is 50 ohm. Setting the computational input impedance to 75 ohm is useful when using a 75 ohm to 50 ohm adapter to measure a 75 ohm device on an analyzer having a 50 ohm input impedance.

Key Path: **Input/Output**

State Saved: Saved in Instrument State

Factory Preset: 50 Ω

Remote Command:

```
[ :SENCE ] :CORRection:IMPedance [ :INPut ] [ :MAGNitude ] 50 | 75
```

```
[ :SENCE ] :CORRection:IMPedance [ :INPut ] [ :MAGNitude ] ?
```

Example: CORR:IMP 75 sets the input impedance correction to 75 ohms.

```
CORR:IMP?
```

2.7.4 Trig Input

Sets the external trigger input source to the front panel trigger input connector (EXT TRIGGER INPUT Ext 1) or the rear panel trigger input connector (TRIGGER IN Ext2).

Key Path: **Trig, External**

Annunciation/

Annotation: At the left side of the display outside the graticule, the letter “E” indicates that the External Trigger is active.

Remote Command:

See [“Trig” on page 287](#)

Example: TRIG:SOUR EXT2 to select rear panel external triggering.

3 Instrument Functions: M – O

This chapter provides key descriptions and programming information for the front-panel key functions of your analyzer starting with the letters M through O. The front-panel functions are listed alphabetically and are described with their associated menu keys. The lower-level menu keys are arranged and described as they appear in your analyzer.

NOTE

The front- and rear-panel features, along with the numeric keypad and alpha-numeric softkey fundamentals are illustrated and described, in your Getting Started guide.

3.1 Marker

Accesses the marker control menu. If no markers are active, pressing **Marker** activates the currently selected marker as a normal type marker and places it at the center of the display. (This will be marker 1 if you have not previously selected a different marker.) There are five control modes for the markers:

Normal (POSITION) - A single marker that can be moved to any point on the trace.

Delta (DELTA) - A fixed reference marker and a moveable marker that you can place at any point on the trace

Delta Pair (BAND) - Both a movable delta and a movable reference marker. You can independently adjust the position of each marker.

Span Pair (SPAN) - A moveable reference and a movable delta marker. You can adjust the center point of the markers and the frequency span between the markers.

Off (OFF) - Turns off the active marker or marker pair.

Your instrument stores data to a high degree of resolution and accuracy. It is often difficult to read the trace data directly from the screen to the desired accuracy. Markers are diamond-shaped pointers that can be placed at any point on a trace to accurately read the data at that point. Markers may also be use in pairs to read the difference (or *delta*) between two data points. The marker number is indicated above the marker. Use the data controls to position the marker. The knob and/or Up/Down keys move the marker left or right. If a value is entered from the numeric keypad, the marker is moved to the trace point nearest to that value.

The data for the *active* marker (the one currently be controlled) appears in the upper-right corner of the display. In addition, when a marker is being actively controlled, the marker data appears in the active function area of the display. There are four markers in your instrument; each can be controlled as a single marker or as a reference/delta pair.

A *trace* is a connected series of points displayed on the instrument screen. The left-most point is point 0 and the right-most point (default) is 600. You control markers by moving them from trace point to trace point. *Markers* are shaped like diamonds. The lowest point of the diamond shape represents the trace point that is being read. The marker number is indicated above the active marker. The same marker number is indicated with an R (for example, 1R) above the reference marker when in a delta mode (delta, delta pair, and span pair).

Marker Units

- **Normal** markers - the display shows the value of the Y-axis position of the marker in the current Y-axis units. (See **Amplitude, Y Axis Units**.)
- **Delta, Delta Pair, or Span Pair** markers - the display shows the ratio (difference when expressed in dB) between two markers. If the Y-axis units are logarithmic (dBm, dBmV, dBuV) the ratio is express in dB. If the Y-axis units are linear (volts, watts) the ratio is expressed in percent (where 100% is the same as 0 dB difference). Note that the value when the Y-axis units are watts is the square of the value when the Y-axis units are

volts. For example, when the percent ratio with Y-axis units in volts is 20% (0.2), the percent ratio with Y-axis units in watts will be 4% ($0.2^2 = 0.04$). When you read the value out remotely you have to know whether you are in log (dB) or linear (percent).

- Marker functions (**Marker Noise** and **Band/Intvl Power**) - the display shows the values with units that are dependent on the function and the Y-axis units. Refer to the individual function descriptions for more details about the units used. When you read the value out remotely you have to know what the expected units are.

Remote Command:

```
:CALCulate:MARKer [1] | 2 | 3 | 4:MODE POSition|DELTA|BAND|SPAN|OFF
```

```
:CALCulate:MARKer [1] | 2 | 3 | 4:MODE?
```

Sets or queries the marker control mode (see parameter list above).

```
:CALCulate:MARKer [1] | 2 | 3 | 4:X <param>
```

Sets the marker X position to a specified point on the X axis in the current X-axis units (frequency or time). If the frequency or time chosen would place the marker off screen, the marker will be placed at the left or right side of the display, on the trace. This command will have no effect if the marker is **OFF**.

```
:CALCulate:MARKer [1] | 2 | 3 | 4:X?
```

Queries the marker X position in the current x-axis units. The marker must be **ON** for the response to be valid.

```
[ :SENSe ] :MARKer [1] | 2 | 3 | 4:X:POSition <param>
```

Sets the marker X position to a specified point on the X axis in display points (values of 0 to 600, or the current number of points in the sweep). The marker must already be on.

```
[ :SENSe ] :MARKer [1] | 2 | 3 | 4:X:POSition?
```

Returns the current marker X position in display points.

```
:CALCulate:MARKer [1] | 2 | 3 | 4:Y?
```

Queries the marker Y value or delta in the current y axis units. Can also be used to read the results of marker functions such as **Marker Noise**. The marker must be **ON** for the response to be valid.

Remote Command Notes: The `:CALC:MARK:PEAK:SEARC:MODE MAX|PAR` command specifies how a peak is identified for use with the marker commands. See [“Peak Search” on page 218](#).

Example: `CALC:MARK:MODE POS` selects marker 1 and sets it to **Normal**.

`CALC:MARK2:X 20 GHZ` selects marker 2 and moves it to 20 GHz. (Marker 2 must first be turned on.)

3.1.1 Select Marker

Selects one of the four possible marker or marker pairs. Once a marker is selected, it can be set to any of the control modes, **Normal**, **Delta**, **Delta Pair**, **Span Pair**, or **Off**.

Key Path: **Marker**

State Saved: The number of the selected marker is saved in instrument state.

Factory Preset: Marker 1

Remote Command:

```
:CALCulate:MARKer[1] | 2 | 3 | 4:STATe OFF|ON|0|1
```

```
:CALCulate:MARKer[1] | 2 | 3 | 4:STATe?
```

Sets or queries the state of a marker. Setting a marker to state ON or 1 selects that marker. Setting a marker which is OFF to state ON or 1 puts it in **Normal** mode and places it at the center of the display. Setting a marker to state OFF or 0 selects that marker and turns it off. The response to the query will be 0 if OFF, 1 if ON.

Example: `CALC:MARK2:STAT ON` selects marker 2.

`CALC:MARK:STAT ON` will not modify a marker that is already on.

3.1.2 Normal

Sets the control mode for the selected marker to **Normal** (see [“Marker” on page 177](#)). If the marker is off, a single marker is activated at the center of the display. The marker stays on the trace at the horizontal screen position where it was placed unless **Signal Track**, or a “marker to” key function (such as **Mkr** → **CF**, **Mkr** → **RL**, **Mkr** → **CF STEP**, **Mkr** Δ **Span**, or **Min Search**) is selected. If you are in a marker pair mode, for example **Delta Marker**, the reference marker is turned off. You can then adjust the trace point of the marker.

Key Path: Marker

Remote Command:

See [“Marker” on page 177](#) for the mode command.

Example: `:CALC:MARK:MODE POS` selects marker 1 and sets it to **Normal**.

3.1.3 Delta

Sets the control mode for the selected marker to **Delta** (see “[Marker](#)” on page 177). In **Delta** mode the display shows the difference between the active (**Delta**) marker and a reference marker. When **Delta** mode is selected the reference marker is placed at the current marker position. If the marker is **OFF** both the active marker and the reference marker are placed at the center of the display. The amplitude and frequency (or time) of the first marker is fixed. The marker number is indicated above the delta marker, and the same number is indicated with an R (for example, 1R) above the reference marker. You can adjust the trace point of the active delta marker. Annotation in the active function block and in the upper-right corner of the display indicates the frequency or time difference and amplitude difference of the two markers. If marker noise is set to On while using Delta and the noise marker is placed on the noise floor, the marker readout displays signal to noise.

Selecting **Delta** while already in **Delta** mode causes the reference marker to be reset to the current active (Δ) marker position, enabling you to make delta measurements from differing reference points without having to turn off the markers and begin again. Pressing Marker Normal moves the Reference Marker to the Delta Marker position and turns off Delta Marker.

The amplitude of the reference marker is fixed. In non-zero spans the frequency of the reference marker is fixed. If the center frequency of the analyzer is changed such that the reference marker is off the screen, an arrow will appear with the marker number at the left or the right side of the display. This indicates where the trace point is for the reference marker.

In **Zero Span** the reference marker remains fixed at the trace point on which it was placed. Also, changing **Center Frequency** does not move the reference marker while in **Zero Span**.

The markers will be turned off if the scale type is changed between log and linear.

Key Path: Marker

Remote Command:

See “[Marker](#)” on page 177 for the mode command.

Example: CALC:MARK4:MODE DELT selects marker 4 as a delta marker and places a reference marker at the marker 4 position. If marker 4 is OFF it places both the active and the reference markers at the center of the display.

3.1.4 Delta Pair

Sets the control mode for the selected marker to **Delta Pair** (see “[Marker](#)” on page 177). In **Delta Pair** mode the display shows the difference between the delta marker and a reference marker and enables you to adjust both the **Ref** (start) and **Delta** (stop) markers independently. After you turn on the delta Pair function, pressing the key again toggles between the two markers you are controlling. When Ref is underlined you are controlling the reference marker. When Δ is underlined you are controlling the delta marker. The start marker number is indicated with a number and an R above the marker (for example, 1R) and the delta marker is indicated with a marker number.

There are four conditions that can occur when **Delta Pair** mode is selected.

- If marker mode is **Off**, the delta marker and reference marker are placed at the center of the display.
- If marker mode is **Normal**, the delta marker and reference marker are placed at the current marker position on the trace.
- If the marker mode is **Delta**, the current marker position remains unchanged and the reference marker is placed on the trace at the reference marker position.
- If the marker mode is **Span Pair**, the marker positions remain unchanged.

The difference between **Delta Pair** and **Delta** modes is that in **Delta Pair** mode the reference marker stays on the trace and you can adjust its trace point. The note (Tracking Ref) appears on the **Delta Pair** key because, in effect, the reference marker “tracks” the trace. (By comparison, in **Delta** mode the reference marker does not track changes in the trace results, it remains anchored in amplitude and frequency.)

Once positioned, the markers stay on the trace points you have selected. Ref and Delta markers maintain their displayed x-axis location, but not their frequency values when you change a parameter that redefines the x-axis scale. Reset these markers when parameters such as Span or Center Freq are changed. Adjusting the Span changes the difference between the two markers. Changing the Center changes the center point of the two markers. This function is useful in functions such as Band Power. Changing the frequency or sweep time of the analyzer does not change the trace point of the markers. You cannot move the markers off the screen.

Key Path: **Marker**

Factory Preset: Ref is the active parameter. Factory preset marker mode is Off.

Range: Refer to the [:SENSE]:SWEep:POINTs command under “Points” on page 244.

Remote Command:

See “Marker” on page 177 for the command to select the control mode.

```
:CALCulate:MARKer[1]|2|3|4:X:POSition:START <param>
```

```
:CALCulate:MARKer[1]|2|3|4:X:POSition:STOP <param>
```

Sets the reference (Start), or delta (Stop) marker X position to a specified point on the X axis in display points (values of 0 to 600, or the current number of points in the sweep). The marker must already be on.

```
:CALCulate:MARKer[1]|2|3|4:X:POSition:START?
```

```
:CALCulate:MARKer[1]|2|3|4:X:POSition:STOP?
```

Returns the reference (Start), or delta (Stop) marker X position in display points.

Example: CALC:MARK3:MODE BAND activates or selects marker 3 and sets it to **Delta Pair**. Refer to “Marker” on page 177.

```
CALC:MARK3:X:POS:STAR 0 moves the reference marker 3 to the left edge
```

of the display.

3.1.5 Span Pair

Sets the control mode for the selected marker to **Span Pair** (see “[Marker](#)” on page 177). In **Span Pair** mode the display shows the difference between the delta marker and a reference marker and enables you to adjust both the ref and delta markers. The start marker number is indicated with a number and an R above the marker (for example, 1R) and the stop marker is indicated with a marker number. After you turn on the Span Pair function, pressing the key again toggles between the two marker parameters you are controlling, span and center.

Adjusting the Span (Span is underlined) changes the frequency difference between the two markers. Adjusting Center (Center is underlined) maintains the marker spacing and changes the frequency of the midpoint between the markers. Adjusting the span changes the frequency difference between the two markers while maintaining the midpoint between the two markers at a fixed frequency. Changing the center changes the center point between the two markers while maintaining the frequency difference.

There are four conditions that can occur when **Span Pair** mode is selected.

- If marker mode is **Off**, the delta marker and reference marker are placed at the center of the display.
- If marker mode is **Normal**, the delta marker and reference marker are placed at the current marker position on the trace.
- If the marker mode is **Delta**, the current marker position remains unchanged and the reference marker is placed on the trace at the reference marker position.
- If the marker mode is **Delta Pair**, the marker positions remain unchanged.

The difference between **Span Pair** and **Delta** modes is that in **Span Pair** mode the reference marker stays on the trace and you can adjust its trace point.

Once positioned, the markers stay on the trace points on which they have been placed. Changing the frequency or time of the analyzer does not change the trace point of the markers, that is, they stay at the same horizontal position on the display.

You cannot move the markers off the screen. If you adjust either center or span to a value that would cause one of the markers to move off screen, the marker will be placed at the right or left side of the display, on the trace. Changing the Center marker changes the center point of the two markers. This function is useful in functions such as Band Power.

Key Path: **Marker**

Range: Refer to the [:SENSE]:SWEep:POINTs command under “[Points](#)” on page 244.

Remote Command:

See “[Marker](#)” on page 177 for the command to select the control mode.

```
:CALCulate:MARKer[1] | 2 | 3 | 4:X:POSition:CENTer <param>
```

Sets the mid point of the markers to a specific trace point.

```
:CALCulate:MARKer[1] | 2 | 3 | 4:X:POSition:CENTer?
```

Returns the midpoint trace point.

```
:CALCulate:MARKer [1] | 2 | 3 | 4 :X:POSition:SPAN <param>
```

Sets the spacing between the markers to a specified number of trace points.

```
:CALCulate:MARKer [1] | 2 | 3 | 4 :X:POSition:SPAN?
```

Returns the spacing of the markers in trace points.

```
:CALCulate:MARKer [1] | 2 | 3 | 4 :X:CENTer <param>
```

Sets the mid point of the markers to a specific frequency with a range that matches the units of the trace on which the markers are positioned.

```
:CALCulate:MARKer [1] | 2 | 3 | 4 :X:CENTer?
```

Returns the midpoint frequency.

```
:CALCulate:MARKer [1] | 2 | 3 | 4 :X:SPAN <param>
```

Sets the spacing between the markers to a specified frequency with a range that matches the units of the trace on which the markers are positioned.

```
:CALCulate:MARKer [1] | 2 | 3 | 4 :X:SPAN?
```

Returns the spacing of the markers in frequency.

Example: `CALC:MARK3:MODE SPAN` selects marker 3 and sets it to **Span Pair**.

`CALC:MARK4:X:POS:SPAN 200` sets the spacing between the markers to 200 trace points for marker pair 4.

`CALC:MARK2:X:POS:CEN 300` sets the midpoint between the markers to the 300th trace point from the left of the display. For a 601 point trace this will be the middle of the display.

3.1.6 Off

Turns off the selected marker. In addition, **Off** turns off functions related to the selected marker such as **Signal Track**, **Band/Intvl Power**, and **Marker Noise** and removes marker annotation from the display.

Key Path: Marker

Remote Command:

See [“Select Marker” on page 180](#) for the command to select the control mode.

Example: `CALC:MARK3:STAT OFF` selects marker 3 and sets it to **Off**.

3.1.7 Marker Trace

Selects the trace that you want your marker or marker pair to be placed on. You can pick

Instrument Functions: M - O

Marker

Marker Trace 1, 2, or 3, or Auto. In **Auto** mode, the analyzer places markers on the lowest-numbered trace that is in **Clear Write** mode. If no trace is in **Clear Write** mode, it places the marker on the lowest-numbered trace in **Max Hold** mode. If there are none, then it uses the lowest-number trace in **Min Hold** mode, then in **View** mode. For example, if trace 1 is in view, and trace 2 is in clear write, any new marker is assigned to trace 2.

Key Path: **Marker**

State Saved: The **Marker Trace** for each marker is saved in instrument state.

Factory Preset: Auto on, Trace 1

Range: 1 to 3

Remote Command:

```
:CALCulate:MARKer [1] | 2 | 3 | 4:TRACe 1 | 2 | 3
```

Puts the marker on the specified trace and turns **Auto** OFF for that marker.

```
:CALCulate:MARKer [1] | 2 | 3 | 4:TRACe?
```

The query returns the number of the trace on which the marker currently resides, even if that marker is in **Auto** mode.

```
:CALCulate:MARKer [1] | 2 | 3 | 4:TRACe:AUTO OFF | ON | 0 | 1
```

Turning **Auto** off sets the **Marker Trace** value to the number of the trace on which the marker currently resides.

```
:CALCulate:MARKer [1] | 2 | 3 | 4:TRACe:AUTO?
```

The response to the query will be 0 if OFF, 1 if ON.

Example: `CALC:MARK1:TRAC 2` places marker 1 on trace 2.

3.1.8 Readout

This access a menu that enables you to affect how the x-axis information for the selected marker is displayed in the marker area (top-right of display) and the active function area of the display. It only affects the readout on the display of the horizontal position information (for example, frequency).

NOTE It does not affect the way this information is sent remotely in response to the `CALC:MARK:X?` command.

Key Path: **Marker**

State Saved: In instrument state, for each marker.

Factory Preset: Frequency for non-zero spans and Time for zero spans.

Remote Command:

```
:CALCulate:MARKer [1] | 2 | 3 | 4:X:READout FREQUency | TIME | ITIME | PERiod
```

:CALCulate:MARKer [1] | 2 | 3 | 4 :X:READout?

Example: CALC:MARK3:X:READ TIME sets the marker 3 **Readout** to **Time**.

3.1.8.1 Frequency

Sets the marker readout to **Frequency**, displaying the absolute frequency of a normal marker or the frequency of the delta marker relative to the reference marker. Frequency readout is the default setting in non-zero spans and is not available in zero spans.

Key Path: Marker, Readout

Remote Command:

See [“Readout” on page 186](#) for this command.

Example: CALC:MARK2:X:READ FREQ sets the marker 2 **Readout** to **Frequency**.

3.1.8.2 Period

Sets the marker readout to **Period**, displaying the reciprocal of the frequency at the marker position, or the reciprocal of the frequency separation of the two markers in a delta-marker mode. Period readout is not available in zero spans. If the markers are at the same frequency in a delta marker mode, the result will be the reciprocal of 0, which is infinitely large. The display will show a very large number.

Key Path: Marker, Readout

Remote Command:

See [“Readout” on page 186](#) for this command.

Example: CALC:MARK2:X:READ PER

3.1.8.3 Time

Sets the marker readout to **Time**, displaying the time interval between a normal marker and the start of a sweep or the time of the delta marker relative to the reference marker. Time is the default setting in zero spans. With a span of zero, the time value is the time position relative to the start of the sweep. In a delta-marker mode it is the (sweep) time interval between the two markers.

Key Path: Marker, Readout

Remote Command:

See [“Readout” on page 186](#) for this command.

Example: CALC:MARK2:X:READ TIME

3.1.8.4 Inverse Time

Sets the marker readout to Inverse Time, displaying the reciprocal of (sweep) time between two markers. This function is only available when in both zero span and in a delta-marker modes. If the markers are at the same x position, the time between them is 0, so the reciprocal of sweep time is infinitely large. The display will show a very large number.

Key Path: Marker, Readout

Remote Command:

See [“Readout” on page 186](#) for this command.

Example: :CALC:MARK2:X:READ ITIM

3.1.9 Marker Table

When set to On the display is split into a measurement window and a marker data display window. For each marker pair, information is displayed in the data display window, which includes the marker number, trace number, marker type, X axis value, and the amplitude of the marker or the delta value, if a delta marker, or the function value, if in a marker function such as **Marker Noise** or **Band/Intvl Power**.

NOTE Selecting any measurement (including **Meas Off**) under **Measure**, turns off the marker table.

Key Path: **Marker**

Factory Preset: Off

Remote Command:

:CALCulate:MARKer:TABLE:STATe OFF|ON|0|1

:CALCulate:MARKer:TABLE:STATe? returns 1 if ON or 0 if OFF.

Example: CALC:MARK:TABL:STAT ON turns on the marker table.

3.1.10 Marker All Off

Turns off all markers, including markers used for signal track. This key also turns off marker related functions such as **Signal Track**, **Band Interval Power**, and **Marker Noise**.

Key Path: **Marker**

Remote Command:

:CALCulate:MARKer:AOFF

Example: CALC:MARK:AOFF turns off all markers.

Instrument Functions: M - O
Marker

3.2 Marker Fctn

Access special marker functions such as frequency counting and noise markers.

Factory Preset: Off

Remote Command:

```
:CALCulate:MARKer [1] | 2 | 3 | 4 :FUNction BPOWer | NOISe | OFF
```

```
:CALCulate:MARKer [1] | 2 | 3 | 4 :FUNction?
```

Example: CALC:MARK:FUNC NOIS

3.2.1 Select Marker

See [“Select Marker” on page 180](#)

Remote Command:

Example: CALC:MARK2:STAT ON selects marker 2.

3.2.2 Marker Noise

Activates a noise marker for the selected marker. If the selected marker is off it is turned on and located at the center of the display. Reads out the average noise level, normalized to a 1 Hz noise power bandwidth, around the active marker. The noise marker averages 5% of the trace data values, centered on the location of the marker.

The data displayed (if the marker is in Normal mode) is the noise density around the marker. The value readout is followed by “(1 Hz)” to remind you that display is normalized to a one Hz bandwidth.

To measure carrier to noise ratio, be sure that the **Marker Fctn** is *not* **Marker Noise**. Select a **Marker, Normal** type marker. Place the marker on the signal peak, then select **Delta** marker. Now place the active (Δ) marker on the noise, and select **Marker Noise** to change the marker type. In this case, the reference marker has units of amplitude and the data displayed is the ratio of the noise density at the delta marker to the reference marker power. The value readout is dB/Hz if the Y-axis units are logarithmic, and % if the Y-axis units are linear. It is understood, in this case, that % stands for the units $\%/\sqrt{\text{Hz}}$ for volts units and $\%/\text{Hz}$ for watts units.

To measure the ratio of the noise densities at two locations, be sure that the **Marker Fctn** is **Marker Noise**. (The noise is averaged over a region that is 5% of the span, centered at the marker location.) Select **Marker, Normal** before selecting **Delta** marker. Then move the active (Δ) marker to the second noise location. In this case both markers have units of noise density (for example, dBm/Hz), so the data displayed represents the ratio of the noise density at the delta marker to the noise density at the reference marker. The value readout

Instrument Functions: M - O
Marker Fctn

is displayed as a ratio (dB or %).

To guarantee accurate data for noise-like signals, a correction for equivalent noise bandwidth is made by the analyzer. The **Marker Noise** function accuracy is best when the detector is set to **Average** or **Sample**, because neither of these detectors will peak-bias the noise. The trade off between sweep time and variance of the result is best when **Avg/VBW Type** is set to Power Averaging. **Auto** coupling, therefore, normally chooses the **Average** detector and **Power Averaging**. The Marker Noise function works with all settings of detector and **Avg/VBW Type**, but using the positive or negative peak detectors does not give less accurate measurement results.

Note that the value when the Y-axis units are watts is the square of the value when the Y-axis units are volts. For example, when the percent ratio with Y-axis units in volts is 20% (0.2), the percent ratio with Y-axis units in watts will be 4% ($0.2^2 = 0.04$). When you read the value out remotely you have to know whether you are in log (dB) or linear (percent), and if linear, whether volts or watts.

Key Path: **Marker Fctn**

Dependencies/

Couplings: **Video** triggering is not available when the detector is **Average**, therefore marker functions that would set the detector to **Average**, and thus conflict with video triggering, are not available when the **Video** trigger is **On**.

Remote Command:

See “[Marker Fctn](#)” on page 191 for the command to select a function.

Example: `CALC:MARK:FUNC NOIS` turns on marker 1 as a noise marker.

`CALC:MARK:FUNC?` returns the current setting of marker function for the marker specified. In this case it returns the string: NOIS.

`CALC:MARK:Y?` returns the y-axis value of the **Marker Noise** function for marker 1 (if **Marker Noise** is ON for marker 1).

3.2.3 Band/Intvl Power

Measures the power in a bandwidth (non-zero span) or time interval (zero span) specified by the user. If no marker is on, this key activates the delta pair marker mode. If the detector mode is set to **Auto**, the average detector is selected. If the **Avg/VBW** type is set to **Auto**, **Power Averaging** is selected, other choices of detector and **Avg/VBW** type will usually cause measurement inaccuracy. The active marker pair indicate the edges of the band. Only **Delta Pair** and **Span Pair** marker control modes can be used while in this function, selecting any other mode (for example, **Normal** or **Delta**) turns off this function.

Key Path: **Marker Fctn**

Dependencies/

Couplings: **Video** triggering is not available when the detector is **Average**, therefore, marker functions that would set the detector to **Average**, and thus conflict with video triggering, are not available when the **Video** trigger is **On**.

Selecting **Band/Intvl Power** when the marker control function is off, normal, or delta will set the marker control function to delta pair.

Remote Command:

See “[Marker Fctn](#)” on page 191 for the command to select the function.

Example: `CALC:MARK:FUNC BPOW` turns on marker one as a band power marker.

`CALC:MARK:Y?` returns the value of the **Band/Intvl Power** function for marker 1 (if **Band/Intvl Power** is ON for marker 1).

3.2.4 Function Off

Turns off marker functions (**Band/Intvl Power** and **Marker Noise**).

NOTE Delta markers will remain on screen.

Key Path: **Marker Fctn**

Remote Command:

See “[Marker Fctn](#)” on page 191 for the command to select the function.

Example: `CALC:MARK2:FUNC OFF` turns the marker 2 function off.

3.2.5 Marker Count

Accesses the marker count menu.

Key Path: **Marker Fctn**

3.2.5.1 Marker Count

Turns the marker frequency counter on and off for any active marker. If no marker is active before **Marker Count** is pressed, a marker is activated at the center of the display. An asterisk (*) may appear in the upper-right area of the display along with the message Cntr 1 (the number in the message depends on the active marker). If the marker count function is on and you change the active marker, the new active marker will use marker count. If the frequency counter function is on with only one active marker and that marker is turned off, then the frequency counter function is turned off. If the frequency counter function is on with multiple markers turned on and only one is turned off, the frequency counter function stays on. **Marker Count** frequency readings are not affected by the frequency offset function.

In **Zero Span** the counter continues to function, counting any signal near the center frequency of the analyzer.

NOTE Setting **Marker Fctn** to Off does not turn **Marker Count** off.

Key Path: **Marker Fctn, Marker Count**

State Saved: If **Marker Count** is on, that setting is saved in the instrument state.

Factory Preset: Off

Remote Command:

:CALCulate:MARKer [1] | 2 | 3 | 4 :FCOunt [:STATE] OFF|ON|0|1

:CALCulate:MARKer [1] | 2 | 3 | 4 :FCOunt [:STATE] ?

:CALCulate:MARKer [1] | 2 | 3 | 4 :FCOunt :X?

Remote Command Notes: Using the CALC:MARK[1] | 2 | 3 | 4:FCO command.

If the specified marker number in the command is not the active marker, it becomes the active marker. If the marker number is not turned on, it is first turned on and then it becomes the active marker. Once the marker count function is turned on, it will be on for any active marker, not just the marker number specified when the command was sent.

Using the CALC:MARK[1] | 2 | 3 | 4:FCO:X? query.

The query returns a 1 only if the marker count function is on and the marker number selected is the currently active marker. The query returns 9e15 if the marker count function is off, or if the specified marker is not the active marker.

Example: CALC:MARK2:FCO ON

CALC:MARK2:FCO:X? returns the counted frequency.

3.2.5.2 Gate Time

Controls the length of time during which the frequency counter measures the signal frequency. For 2 ms and longer gate times, the counter resolution is 0.001 Hz. Longer gate times allow for greater averaging of signals whose frequency is “noisy”, at the expense of throughput. If the gate time is an integer multiple of the length of a power-line cycle (20 ms for 50 Hz power, 16.67 ms for 60 Hz power), the counter rejects incidental modulation at the power line rate. The shortest gate time that rejects both 50 and 60 Hz modulation is 100 ms, which is the value chosen when gate time is in **Auto**.

Key Path: **Marker Fctn, Marker Count**

State Saved: Saved in instrument state.

Factory Preset: Auto, 100 ms

Range: 1 μ s to 500 ms

Remote Command:

```
:CALCulate:MARKer:FCOunt:GATetime:AUTO OFF|ON|0|1
```

```
:CALCulate:MARKer:FCOunt:GATetime:AUTO?
```

```
:CALCulate:MARKer:FCOunt:GATetime <time>
```

```
:CALCulate:MARKer:FCOunt:GATetime?
```

Example: CALC:MARK:FCO:GAT:AUTO On

CALC:MARK:FCO:GAT 1e-2 sets the gate time to 10^{-2} s = 10 ms.

3.3 Marker ->

Accesses menu keys that can copy the current marker value into other instrument parameters (for example, **Center Frequency**).

3.3.1 Mkr->CF

Sets the center frequency of the analyzer to the frequency of the selected marker. The marker stays at this frequency, so it moves to the center of the display. This function is not available in **Zero Span**.

Key Path: **Marker ->**

Remote Command:

```
:CALCulate:MARKer [1] | 2 | 3 | 4 [:SET] :CENTer
```

Example: CALC:MARK2:CENT sets the CF of the analyzer to the value of marker 2.

3.3.2 Mkr->CF Step

Sets the center frequency (CF) step size of the analyzer to the marker frequency, or in a delta-marker mode, to the frequency difference between the delta and reference markers. The step size can be verified by pressing **Frequency, Center Freq**. The step size is displayed in the third line of the active function area of the display. This function is not available in **Zero Span**.

Key Path: **Marker ->**

Remote Command:

```
:CALCulate:MARKer [1] | 2 | 3 | 4 [:SET] :STEP
```

Example: CALC:MARK1:STEP sets the CF step to the value (or delta value) of marker 1.

3.3.3 Mkr->Start

Changes the start frequency to the frequency of the active marker. The marker stays at this frequency, so it moves to the left of the display. This function is not available in **Zero Span**.

Key Path: **Marker ->**

Remote Command:

```
:CALCulate:MARKer [1] | 2 | 3 | 4 [:SET] :START
```

Instrument Functions: M - O

Marker ->

Example:

CALC:MARK1:STAR sets the start frequency to the value (or delta value) of marker 1.

3.3.4 Mkr->Stop

Changes the stop frequency to the frequency of the active marker. The marker stays at this frequency, so it moves to the right of the display. This function is not available in **Zero Span**.

Key Path: **Marker ->**

Remote Command:

```
:CALCulate:MARKer [1] | 2 | 3 | 4 [:SET] :STOP
```

Example: `CALC:MARK1:STOP` sets the stop frequency to the value (or delta value) of marker 1.

3.3.5 Mkr Δ ->Span

Sets the start and stop frequencies to the values of the delta markers. The marker is then set to normal at the center frequency. Only available in **Delta**, **Span Pair**, and **Delta Pair** modes, this function is not available if the marker is off, or in **Normal** mode or when the span is **Zero Span**.

Key Path: **Marker ->**

Remote Command:

```
:CALCulate:MARKer [1] | 2 | 3 | 4 [:SET] :DELTA:SPAN
```

Remote Command Notes: Select the delta marker mode with
`:CALCulate:MARKer [1] | 2 | 3 | 4 :MODE DELTA.`

Example: `CALC:MARK2:DELT:SPAN` sets the start and stop frequencies to the values of the delta markers of marker 2.

3.3.6 Mkr Δ ->CF

Sets the delta marker to the center frequency. Only available in **Delta**, **Span Pair**, and **Delta Pair** modes, this function is not available if the marker is off, or in **Normal** mode or when the span is **Zero Span**.

Key Path: **Marker ->**

History: Added with firmware revision A.02.00

Remote Command:

```
:CALCulate:MARKer [1] | 2 | 3 | 4 [:SET] :DELTA:CENTer
```

Remote Command Notes: Select the delta marker mode with
`:CALCulate:MARKer [1] | 2 | 3 | 4 :MODE DELTA.`

Example: `CALC:MARK2:DELT:CENT` sets the center frequency to the value of the delta marker center frequency of marker 2.

3.3.7 Mkr->Ref Lvl

Sets the reference level to the amplitude value of the active marker, moving the marked point to the reference level (top line of the graticule).

Key Path: **Marker ->**

NOTE The reference level range is limited by the input attenuator setting, the maximum mixer level, the preamp setting, etc.

Remote Command:

:CALCulate:MARKer [1] | 2 | 3 | 4 [:SET] :RLEVel

Example: `CALC:MARK2:RLEV` sets the reference level of the analyzer to the amplitude of marker 2.

3.4 Meas Setup (SA with Measurements Off)

3.4.1 Measurement Setup

Displays the setup menu for the currently selected measurement. This menu is empty if no measurement is active. This could be because **Meas Off** is selected in the **Measure** menu.

Key Path: Front-panel key

Dependencies/

Couplings: Menu choices depend on the currently selected Mode and Menu

Remote Command:

There is no equivalent remote command.

Instrument Functions: M - O
Meas Setup (SA with Measurements Off)

3.5 MODE

Selects the measurement mode of your analyzer. Spectrum Analysis mode is for general purpose measurement use. The instrument comes with the Spectrum Analysis mode. Additional measurement modes can be added to your instrument memory. Refer to the individual measurement personality mode manuals for instructions on how to install the software.

Dependencies/

Couplings: Other modes, besides Spectrum Analysis, must be installed/licensed in your instrument before they will appear in the **Mode** menu. Some modes also require the presence of specific hardware.

Saved State: Saved in instrument state.

SCPI Status Bits/

OPC Dependencies: If you are using the status bits and the analyzer mode is changed, the status bits should be read, and any errors resolved, prior to switching modes. Error conditions that exist prior to switching modes cannot be detected using the condition registers after the mode change. This is true unless they recur after the mode change, although transitions of these conditions can be detected using the event registers.

Changing modes resets all SCPI status registers and mask registers to their power-on defaults. Hence, any event or condition register masks must be re-established after a mode change. Also note that the power up status bit is set by any mode change, since that is the default state after power up.

Factory Preset: Spectrum Analysis

If **Preset Type Mode** is selected, then the analyzer settings are preset but it stays in that selected mode.

Remote Command:

```
:INSTRument [:SElect]
BASIC|CDMA|CDMA1XEV|CDMA2K|EDGEgSM|LINK|NADC|NFIGURE|PDC|PNOISE|SA|WCDMA
:INSTRument [:SElect] ?
```

Instrument Functions: M - O

MODE

Remote Command Notes:

Select the measurement mode. The actual available choices depend upon which modes (measurement applications) are installed in the instrument. A list of the valid choices is returned with the INST:CAT? query.

Once an instrument mode is selected, only the commands that are valid for that mode can be executed.

BASIC
 CDMA1XEV (1xEV-DO)
 CDMA2K (cdma2000)
 EDGE GSM (GSM with EDGE)
 LINK (89600 VSA Link software)
 NADC
 NFIGURE (noise figure)
 PDC
 PNOISE (phase noise)
 SA
 TDSCDMA
 WCDMA (3GPP)

Example: INST SA
 INST?

3.5.1 Spectrum Analysis

Selects the spectrum analysis measurement mode for your analyzer.

Key Path: **Mode**

Remote Command:

:INSTrument[:SElect] SA

Example: INST SA
 INST?

3.5.2 Application Mode Number Selection (Remote command only)

Select the measurement mode by its mode number. The actual available choices depend upon which applications are installed in your instrument.

Dependencies/

Couplings: Other modes, besides Spectrum Analysis, must be installed/licensed in your instrument before they will appear in the **Mode** menu. Some modes also require the presence of specific hardware.

SCPI Status Bits/

OPC Dependencies: If you are using the status bits and the analyzer mode is changed, the status bits should be read, and any errors resolved, prior to switching modes. Error conditions that exist prior to switching modes cannot be detected using the condition registers after the mode change. This is true unless they recur after the mode change, although transitions of these conditions can be detected using the event registers.

Changing modes resets all SCPI status registers and mask registers to their power-on defaults. Hence, any event or condition register masks must be re-established after a mode change. Also note that the power up status bit is set by any mode change, since that is the default state after power up.

Factory Preset: 1 (Spectrum Analysis)

If **Preset Type Mode** is selected, then the analyzer settings are preset but it stays in that selected mode.

Remote Command:

```
:INSTRument:NSElect <integer>
```

```
:INSTRument:NSElect?
```

Remote Command Notes: Enter one of the following integers in the command to set the analyzer mode.

Mode	NSElect Number	Mode Keyword
Basic	8	BASIC
cdmaOne	4	CDMA
CDMA1xEV-DO	15	CDMA1XEV
cdma2000	10	CDMA2K
EDGE with GSM	13	EDGE GSM
89600 VSA Link Software	231	LINK
NADC	5	NADC
Noise Figure	219	NFIGURE
PDC	6	PDC
Phase Noise	14	PNOISE
Spectrum Analysis	1	SA
W-CDMA for 3GPP	9	WCDMA

Example: INST:NSEL 4

3.5.3 Application Mode Catalog Query (Remote command only)

Returns a comma separated list of strings that contain the names of all the installed applications/modes. These names can only be used with the **INST:SELECT** command.

Remote Command:

:INSTrument:CATalog?

Example: INST:CAT?

Query response: "SA","CDMA","PNOISE"

4 Instrument Functions: P – Z

This chapter provides key descriptions and programming information for the front-panel key functions of your analyzer starting with the letters P through Z. The front-panel functions are listed alphabetically and are described with their associated menu keys. The lower-level menu keys are arranged and described as they appear in your analyzer.

NOTE

The front- and rear-panel features, along with the numeric keypad and alpha-numeric softkey fundamentals are illustrated and described, in your Getting Started guide.

4.1 Peak Search

Places a marker on the highest peak and displays the search menu. If **Peak Search Type** (Param) is set to **Excursion & Threshold**, the peak found must meet the defined peak excursion and threshold values. (See “[Search Param](#)” on page 215.) Peaks that are less than 1% of the current span away from 0 Hz are ignored. For example, if **Span** is 1 MHz, peaks will not be found between -10 kHz and +10 kHz. If no valid peak is found, an error (No Peak Found) is displayed. To clear this message, press **ESC** before attempting another search.

The peak search parameters are Peak Threshold and Peak Excursion. All searches except Peak Search (Next Peak, Next Left, Next Right, Peak Table, SCPI “PEAKS” command) obey the Search Parameters, which means that only peaks which rise above the Peak Threshold by at least the Peak Excursion are found. Peak Search obeys then when Peak Search is in PARAM mode. When the Peak Search key is in MAX mode, the search parameters are ignored for a Peak Search.

NOTE You can go into the Peak Search menu without actually performing a **Peak Search** by using the front-panel **Return** key (*assuming you have previously accessed the Peak Search menu*). Press **Return** to navigate through the previously accessed menus until you return to the Peak Search menu.

Remote Command:

```
:CALCulate:MARKer [1] | 2 | 3 | 4 :MAXimum
```

Remote Command Notes: The `:CALC:MARK:PEAK:SEARC:MODE MAX|PAR` command specifies how a peak is identified for use with the marker commands. See “[Peak Search](#)” on page 218.

Example: `CALC:MARK2:MAX` performs a peak search using marker 2.

`CALC:MARK2:Y?` queries the marker amplitude (Y-axis) value for marker 2. For more information on this command, see “[Marker](#)” on page 177.

`CALC:MARK2:X?` queries the marker frequency or time (X-axis) value for marker 2. For more information on this command, see “[Marker](#)” on page 177.

4.1.1 Next Peak

Places the marker on the next highest peak with an amplitude less than the current peak. The peak must meet the defined peak excursion and threshold values. Peaks that are less than 1% of the current span away from 0 Hz are ignored. If no valid peak is found, an error (No Peak Found) is displayed. Press **ESC** to clear this message before attempting another search. (Also see the [Peak Excursn](#) and [Pk Threshold](#) key descriptions.)

Key Path: **Peak Search**

State Saved: Not part of saved state.

Remote Command:

:CALCulate:MARKer [1] | 2 | 3 | 4 :MAXimum:NEXT

Example: CALC:MARK2:MAX:NEXT selects marker 2 and moves it to the next highest peak.

4.1.2 Next Pk Right

Moves the marker to the next peak to the right of the current marker. The peak must meet the defined peak excursion and threshold limits. Peaks that are less than 1% of the current span away from 0 Hz are ignored. If no valid peak is found, an error “No Peak Found” is displayed. Press **ESC** to clear this message before attempting another search. (Also see the [Peak Excursn](#) and [Pk Threshold](#) key descriptions.)

Key Path: **Peak Search**

State Saved: Not part of saved state.

Remote Command:

:CALCulate:MARKer [1] | 2 | 3 | 4 :MAXimum:RIGHT

Example: CALC:MARK2:MAX:RIGH selects marker 2 and moves it to the next peak to the right.

4.1.3 Next Pk Left

Moves the marker to the next peak to the left of the current marker. The peak must meet the defined peak excursion and threshold limits. Peaks that are less than 1% of the current span away from 0 Hz are ignored. If no valid peak is found, an error “No Peak Found” is displayed. Press **ESC** to clear this message before attempting another search. (Also see the [Peak Excursn](#) and [Pk Threshold](#) key descriptions.)

Key Path: **Peak Search**

State Saved: Not part of saved state.

Remote Command:

:CALCulate:MARKer [1] | 2 | 3 | 4 :MAXimum:LEFT

Example: CALC:MARK2:MAX:LEFT selects marker 2 and moves it to the next peak to the left.

4.1.4 Min Search

Moves the active marker to the minimum detected amplitude value on the current trace.

Key Path: **Peak Search**

State Saved: Not part of saved state.

Remote Command:

:CALCulate:MARKer [1] | 2 | 3 | 4 :MINimum

Example: CALC:MARK:MIN selects marker 1 and moves it to the minimum amplitude value.

4.1.5 Pk-Pk Search

Finds and displays the amplitude and frequency (or time, if in zero span) differences between the highest and lowest trace points by setting a reference marker on the peak signal and placing a Δ marker on the minimum signal.

Key Path: **Peak Search**

State Saved: Not part of saved state.

Remote Command:

:CALCulate:MARKer [1] | 2 | 3 | 4 :PTPeak

Example: CALC:MARK:PTP

CALC:MARK:Y? queries the delta amplitude value for marker 1. For more information on this command, see “Marker” on page 177.

4.1.6 Mkr->CF

See “Mkr->CF” on page 197 for the command to select this function.

Key Path: **Peak Search**

4.1.7 Continuous Pk

When a marker is placed on a signal and **Continuous Pk** is pressed, the marker will remain on the signal even if the signal frequency changes, as long as the amplitude of the signal does not change by more than 3 dB from one sweep to another.

If the signal is lost, an attempt will be made to find it again and maintain the marker on the signal peak. If there are other signals on screen near the same amplitude, one of them may be found instead. Signals near 0 Hz cannot be maintained effectively, because they cannot be distinguished from the LO feedthrough, which is excluded by intent from the search algorithm.

NOTE This function is intended to maintain the marker on signals with a frequency that is changing, and an amplitude that is not changing.

Key Path: **Peak Search**

State Saved: Saved in instrument state.

Factory Preset: Off

Remote Command:

:CALCulate:MARKer [1] | 2 | 3 | 4 :CPEak [:STATE] OFF | ON | 0 | 1

:CALCulate:MARKer [1] | 2 | 3 | 4 :CPEak [:STATE] ?

Remote Command Notes: This command may not be used to activate a given marker.

Example: CALC:MARK:CPE ON

4.1.8 N dB Points

Activates the N dB function. Pressing **N dB Points (On)** turns on the N dB feature and activates two arrows that are N dB down from the marker. The frequency difference between the two arrows will be displayed in the upper right-hand corner of the display. If the feature is unable to find data N dB below the marker, the value of -100 Hz will be displayed in the upper right-hand corner of the display.

For example, N dB Points can be used to measure the 3 dB bandwidth of a filter in a transmission test with the tracking generator.

The measured signal cannot have more than one peak that is greater than or equal to N dB. A signal must be greater than the peak excursion above the peak threshold to be identified. The setting for peak excursion may be increased from the -6 dB default value so that noise will not be identified as signals. Increasing the value too much may cause a smaller signal to be missed or misinterpreted as part of a larger signal. The amplitude scale may be either linear or logarithmic.

The N dB function follows the active marker. If you turn on a marker after N dB Points has been activated, the arrows will follow that marker. If the marker associated with N dB Points moves, the arrows will move with the marker unless there is no data N dB below the marker.

Key Path: **Peak Search**

Annunciation/

Annotation: Second line in upper right-hand corner N dB <meas result>

State Saved: If **On**, the fact is saved in instrument state.

Factory Preset: Off, -3 dB

Factory

Default: Off, -3 dB

Terminators: dB

Default Terminator: dB

Resolution/

Rounding/

Truncation: 0.01 dB

Knob Increment: 0.1 dB

Step Key

Increment: 10 dB

Range: -80 dB to -1 dB

Remote Command:

:CALCulate:BANDwidth:NDB <dB_value>

:CALCulate:BANDwidth:NDB?

:CALCulate:BANDwidth[:STATe] ON|OFF|1|0

:CALCulate:BANDwidth[:STATe]?

4.1.9 Search Param

Displays the search parameter criteria menu that enables you to adjust the parameters for the peak search functions.

Key Path: **Peak Search**

Remote Command:

There is no remote command for this key.

4.1.9.1 Peak Excursion

Sets the minimum amplitude variation of signals that the marker can identify as a separate peak. For example, if a value of 10 dB is selected, the marker **Next Peak** function moves only to peaks that rise more than 10 dB above the **Peak Threshold** and then fall back to the **Peak Threshold**. This criteria applies to all traces. This function applies to **Next Peak**, **Next Peak Left**, and **Next Peak Right**. If **Peak Search** is set to **Param**, it also applies to **Peak Search**.

Key Path: **Peak Search, Search Param**

Dependencies/

Couplings: This function is not available when **Y-Axis** is set to **Frequency** instead of **Amplitude**.

State Saved: Saved in instrument state.

Factory Preset: 6.0 dB

Factory
 Default: 6.0 dB

Terminators: dB

Default Terminator: dB

Resolution/
 Rounding/
 Truncation: 0.01 dB

Knob Increment: 1 dB

Step Key
 Increment: 1 dB

Range: 0.0 dB to 100 dB

Remote Command:

```
:CALCulate:MARKer [1] | 2 | 3 | 4 :PEAK:EXCursion <rel_amplitude>  
UP | DOWN | MIN | MAX | DEFault
```

```
:CALCulate:MARKer [1] | 2 | 3 | 4 :PEAK:EXCursion?
```

Remote Command Notes: CALC:MARK:PEAK:SEAR:MODE must be set to PARAMeter if

you want Peak Search to take advantage of the threshold excursion.

Example: :CALC:MARK:PEAK:EXC 30 DB sets the minimum peak excursion requirement to 30 dB.

See the full example for the CALC:MARK:PEAK:SEAR:MODE command below.

4.1.9.2 Pk Threshold

Specifies the minimum signal level for the analyzer internal peak identification routine to recognize as a peak. A signal must rise above the **Peak Threshold** by the value specified in **Peak Excursn**, then fall back to the **Peak Threshold**, to be considered a peak. This applies to all traces and all windows. Press **ESC** or select another active function to hide the threshold line. Applies to **Next Peak**, **Next Peak Left**, and **Next Peak Right**. If **Peak Search** is set to **Param**, it also applies to **Peak Search**.

Key Path: **Peak Search**, **Search Param**

Dependencies/

Couplings: This function is not available when **Y-Axis** is set to **Frequency** instead of **Amplitude**.

State Saved: Saved in instrument state.

Factory Preset: -90 dBm

Terminators: dBmV, dB μ V, dB μ A, V, W, A

Default Terminator: dBm

Resolution/

Rounding/

Truncation: .001 dBm

Knob Increment: amp scale = LOG: 1 % of dB/div or 0.01 (the larger of the two)

amp scale = LIN: 0.1 dBm

Step Key

Increment: amp scale = LOG: dB/div

amp scale = LIN:

Range: From the current reference level to the bottom of the display range

Remote Command:

:CALCulate:MARKer[1] | 2 | 3 | 4:PEAK:THReshold <ampl>
UP | DOWN | MIN | MAX | DEFault

:CALCulate:MARKer [1] | 2 | 3 | 4:PEAK:THReshold?

Remote Command Notes: CALC:MARK:PEAK:SEAR:MODE must be set to PARAmeter if you want peak search to take advantage of the threshold excursion.

Example: :CALC:MARK:PEAK:THR -60 dBm sets the threshold to -60 dBm.

See the full example for the CALC:MARK:PEAK:SEAR:MODE command below.

4.1.9.3 Peak Search

Sets the mode for **Peak Search** to either **Max** or **Param** and applies to **Peak Search** only.

- **Max** (Maximum mode) places a marker on the highest peak whenever a **Peak Search** is performed.
- **Param** (Parameter mode) searches only for peaks that meet the values set with **Peak Excursn** and **Pk Threshold**.

Key Path: **Peak Search, Search Param**

State Saved: Saved in instrument state.

Factory Preset: Maximum

Factory Default: Maximum.

Remote Command:

```
:CALCulate:MARKer:PEAK[1] | 2 | 3 | 4:SEARch:MODE PARAmeter|MAXimum
```

```
:CALCulate:MARKer:PEAK[1] | 2 | 3 | 4:SEARch:MODE?
```

Remote Command Notes: If mode is set to **MAXimum** (**Max**), peak search will place the marker at the maximum amplitude in the trace. If mode is set to **PARAmeter** (**Param**), peak search will place the marker at the highest peak that rises and falls by at least the peak excursion above the peak threshold. If no peak meets the excursion and threshold criteria, a No Peak Found error (error 202) is issued.

The following commands are not affected by the setting of **CALC:MARK:PEAK SEAR:MODE**. They will always use the parameter search mode that defines peaks based on peak excursion and peak threshold.

```
:CALCulate:MARKer[1] | 2 | 3 | 4:MAXimum
```

```
:CALCulate:MARKer[1] | 2 | 3 | 4:MAXimum:LEFT
```

```
:CALCulate:MARKer[1] | 2 | 3 | 4:MAXimum:NEXT
```

```
:CALCulate:MARKer[1] | 2 | 3 | 4:MAXimum:RIGHT
```

```
:CALCulate:MARKer:PEAK:TABLE:STATe OFF | ON | 0 | 1
```

Example: `CALC:MARK:PEAK:SEARC:MODE PAR` sets the parameter search mode.

`CALC:MARK:PEAK:THR -60 dBm` sets the threshold to -60 dBm.

`CALC:MARK:PEAK:EXC 30 dB` sets the minimum peak excursion requirement to 30 dB.

`CALC:MARK:STAT ON` turns on marker number 1 and puts it on the active trace at mid screen.

CALC:MARK:MAX puts marker 1 on the highest peak that is at least 30 dB above the -60 dBm threshold.

:CALC:MARK:Y? returns the y-axis (amplitude) value of the marker in current y-axis units.

4.2 Preset

Presetting the instrument provides a known convenient starting point of the instrument state for making measurements. There are three possible actions when you press the **Preset** key:

- For preset type **Mode** (default), the green **Preset** key immediately performs a mode preset. See the descriptions below. Press **System**, **Power On/Preset**, **Preset Type** to select the preset type.
- For preset type **Factory**, the green **Preset** key immediately performs a factory preset. See the descriptions below. Press **System**, **Power On/Preset**, **Preset Type** to select the preset type.
- For preset type **User**, the green **Preset** key brings up a menu of preset key choices. You must press one of these keys to initiate an instrument preset.
 - Pressing **User Preset** resets to the settings/values that you have previously defined as the **User** preset state using the **Save User Preset** key.
 - Pressing **Mode Preset** does not change the mode; it only resets the *current* mode settings to the factory defaults.
 - Pressing **Factory Preset** resets the settings for all the modes to the factory defaults. The factory preset mode is Spectrum Analysis with continuous sweep. If you are not already in the Spectrum Analysis mode, it switches to that mode.
- Pressing **Save User Preset** saves the current user settings.

None of these instrument presets resets “persistent” functions such as GPIB address, time/date display style, or auto-alignment state to the factory defaults. See “[Restore Sys Defaults](#)” on page 231.

If **Preset Type** is set to **Factory** in the **System** menu, pressing the **Preset** front-panel key performs a factory preset, which implements the following:

- Resets the analyzer to Spectrum Analyzer mode.
- Brings up the **Freq** menu, with no active function.
- Sets certain conditions, in all modes, to their default values.
- Clears the input and output buffers and all the trace data.
- Amplitude-correction factors are turned off, but remain in analyzer memory.
- Limit line testing is turned off, but the limit line tables remain in analyzer memory.
- The status byte is set to 0.

NOTE Recalling any state, including the user preset state, will affect the conditions of more parameters than are affected by a factory preset. For example, external preamp gain and input impedance correction are not affected by a factory preset but will be affected by a user preset.

Key Path: Front-panel key

Dependencies/

Couplings: Depends on the preset type (user, mode or factory) setting in the **System**, **Power On/Preset** keys.

SCPI Status Bits/

OPC Dependencies: Clears all pending OPC bits. The status byte is set to 0.

Remote Command:

:SYSTem:PRESet

Remote Command Notes: The `SYSTem:PRESet` command immediately presets the instrument state to values dependent on the preset type that is currently selected (FACTory, USER, MODE).

`SYSTem:PRESet` will not reset “persistent” functions such as IP address, time/date display style, or auto-alignment state to their factory defaults. Use `SYSTem:PRESet:PERSistent`. See “Restore Sys Defaults” on page 231.

`SYSTem:PRESet:TYPE` sets the type of preset. See “Preset Type” on page 211.

Example: `:SYST:PRE:TYPE MODE` sets the preset mode type to mode. See “Preset Type” on page 211.

`:SYST:PRE` presets the instrument to the currently selected preset type.

4.2.1 User Preset

This key is only available when the preset type is set to User. Press **System**, **Power On/Preset**, **Preset Type**, **User**.

Restores the analyzer to a user defined state that has been saved for all analyzer modes. You defined this state when **Save User Preset** was pressed. If the you have never saved a user preset state, then the factory preset state is stored as the user preset state. If the user preset state has been saved but the load fails for any reason, the error message: Unable to load user state is displayed in the status line and the state is reset to whatever it was before the **Preset** key was pressed. This can sometimes happen if firmware has been upgraded or applications have been (un)installed after the user preset state was saved. **Save User Preset** can be accessed by pressing **System**, **Power On/Preset**.

Key Path: **Preset**

Remote Command:

:SYSTem:PRESet See “:SYSTem:PRESet” on page 186.

Example: `SYST:PRE:SAVE` saves a user state that will be used for the preset

`SYST:PRE:TYPE USER` selects the user type preset

`SYST:PRE` immediately presets the analyzer to the user preset.

4.2.2 Mode Preset

This key is only available when the preset type is set to User. Press **System, Power On/Preset, Preset Type, User**.

A mode preset does not change the mode. It resets only the current mode settings to the factory defaults.

Key Path: **Preset**

History: Added with firmware revision A.02.00

Remote Command:

See [“:SYSTem:PRESet” on page 186](#).

*RST

The *RST command always does a mode preset, except that it sets the instrument to do a single sweep/measurement instead of continuous.

Example: SYST:PRE:TYPE MODE selects the mode type preset
SYST:PRE immediately presets the current analyzer mode

4.2.3 Factory Preset

This key is available only when the preset type is set to User. Press **System, Power On/Preset, Preset Type, Factory**.

A factory preset returns instrument settings to the factory default values. If you are not already in the spectrum analysis mode, it switches to that mode. A factory preset does *not* reset “persistent” functions such as GPIB address, time/date display style, or auto-alignment state (see [“Restore Sys Defaults” on page 231](#).)

Key Path: **Preset**

Remote Command:

:SYSTem:PRESet See [“:SYSTem:PRESet” on page 186](#).

Remote Command Notes: This command will not reset “persistent” functions such as GPIB address, time/date display style, or auto-alignment state to their factory defaults. Use SYSTem:PRESet:PERSistent. See [“Restore Sys Defaults” on page 231](#).

Example: SYST:PRE:TYPE FACT selects the factory type preset
SYST:PRE immediately presets the analyzer to its factory defaults

4.2.4 Save User Preset

This key is only available when the Preset Type is set to User. Press **System, Power On/Preset, Preset Type, User**.

Key Path: **Preset** (if preset type is set to User)
 System, Power On/Preset. See [“Save User Preset” on page 213](#)

Remote Command:

:SYSTem:PRESet [:USER] :SAVE

Example: SYST:PRES:TYPE USER
 SYST:PRES:SAVE

4.3 Print

Initiates an output of the display data to the currently defined printer. The screen remains frozen (no further sweeps are taken) until the data transfer to the printer is complete. Refer to the key description for [Print Setup on page 229](#) for more information about the printer functions.

There must be a valid printer set up for the print function to work. The *Getting Started Guide* includes additional printer installation information.

If you need to abort a print in progress, use the **Esc** (escape) key.

Key Path: Front-panel key

Remote Command:

:HCOpy[:IMMediate]

Example: HCOpy

4.3.1 Abort the Printout (Remote Command Only)

This command aborts the print that is currently in process.

Remote Command:

:HCOpy:ABORt

Example: HCOpy:ABOR

4.4 Print Setup

Displays the functions that specify a particular printer and control its output.

Key Path: Front-panel key

Remote Command:

There is no remote command for this key.

4.4.1 Printer Setup

Enables you to define a printer by selecting its printer language and color capability.

Supported printers are equipped with a parallel interface. (A supported printer is one that accepts Printer Control Language Level 3 or 5). Your printer language can be found in its documentation or in the specifications found on the manufacturer's web page.

- PCL3 printers include most HP DeskJet printers.
- PCL5 printers include most HP LaserJet printers.

The table below lists some current Hewlett-Packard™ printers and their settings.

Printer Models	Language Type	Color Capable
HP DeskJet 310	PCL3	yes
HP DeskJet 320	PCL3	yes
HP DeskJet 400	PCL3	yes
HP DeskJet 670C, 672C, 680C, 682C	PCL3	yes
HP DeskJet 720C, 722C	Windows only (not compatible)	
HP DeskJet 600C, 660C, 670C, 680C, 690C	PCL3	yes
HP DeskJet 820C	Windows only (not compatible)	
HP DeskJet 840C, 850C, 870C, 890C, 895C	PCL3	yes
HP DeskJet 935C, 990C	PCL3	yes
HP DeskJet 1120C	PCL3	yes
HP LaserJet 4L, 4P	PCL5	no
HP LaserJet 5, 5L, 5M, 5P, 5MP, 5N	PCL5	no
HP LaserJet 6, 6L, 6M, 6P, 6MP	PCL5	no
HP Professional Series 2500CM	PCL3	yes
HP DesignJet 755CM	PCL5	yes

Key Path: Print Setup

Remote Command:

There is no remote command for this key.

4.4.1.1 Language

Lets you define your printer language as a PCL3 (Deskjet) or PCL5 (Laserjet) printer.

Key Path: **Print Setup, Printer Setup**

State Saved: Persistent, survives **Preset** and power cycle, but not saved in Instrument State.

Remote Command:

:HCOpy:DEvice:LANGUage PCL3 | PCL5

:HCOpy:DEvice:LANGUage?

Example: HCOP:DEV:LANG PCL5

4.4.1.2 Color Capable

Allows you to define whether you printer is color capable (**Yes**) or not (**No**).

NOTE **Color Capable** does *not* specify whether you want a printout in color. See [“Color” on page 234](#) for information.

Key Path: **Print Setup, Printer Setup**

State Saved: Persistent, survives **Preset** and power cycle, but not saved in Instrument State.

Remote Command:

:HCOpy:DEvice:COLor NO | YES

:HCOpy:DEvice:COLor?

Example: HCOP:DEV:COL YES

4.4.2 Orientation

Allows you to select either **Portrait** or **Landscape** printing. **Landscape** is not available with a PCL3 (Deskjet) printer.

Key Path: **Print Setup**

State Saved: Persistent, survives **Preset** and power cycle, but not saved in Instrument State.

Factory Preset: Portrait

Remote Command:

```
:HCOPY:PAGE:ORIENTATION LANDscape|PORTRait
```

```
:HCOPY:PAGE:ORIENTATION?
```

Example: HCOP:PAGE:ORI LAND

4.4.2.1 Portrait

Selects Portrait orientation for the printouts from the analyzer.

Key Path: **Print Setup, Orientation**

Readback: Portrait

Remote Command:

See [“Orientation” on page 231](#).

Example: HCOP:PAGE:ORI PORT

4.4.2.2 Landscape

Selects Landscape orientation for the printouts from the analyzer.

Key Path: **Print Setup, Orientation**

Readback: Landscape

Remote Command:

See [“Orientation” on page 231](#).

Example: HCOP:PAGE:ORI LAND

4.4.3 Prints/Page

Selects the number of display prints per page when orientation is set to Portrait. The page will be ejected after the selected number of prints has been printed.

NOTE For Landscape printing, **Prints/Page** is always set to 1.

Key Path: **Print Setup, Orientation**

State Saved: Persistent, survives **Preset** and power cycle, but not saved in Instrument State.

Factory Preset: 1 print/page

Range: 2

Remote Command:

:HCOpy:PAGE:PRINTs <integer>

:HCOpy:PAGE:PRINTs?

Example: HCOP:PAGE:PRIN 2

4.4.4 Eject Page

Ejects your printed page.

Key Path: Print Setup, Orientation

Remote Command:

:HCOpy:ITEM:FFeEd[:IMMediate]

Example: HCOP:ITEM:FFE

Ejects the page if prints per page is set to 2 and only 1 print has completed. Otherwise the page automatically ejects after the print is complete.

4.4.5 Page Size

Allows you to select from the following page sizes: **Executive**, **Letter**, **Legal**, **Ledger**, **A4**, and **A3**.

Key Path: **Print Setup**

State Saved: Persistent, survives **Preset** and power cycle, but not saved in Instrument State.

Factory Preset: Letter

Remote Command:

:HCOpy:PAGE:SIZE A|B|A3|A4|LETTer|LEGAl|EXECutive|LEDGer

:HCOpy:PAGE:SIZE?

Remote Command Notes: Page size “A” is letter, and page size “B” is ledger. There is no size standardization for “legal” or “executive.”

Example: HCOP:PAGE:SIZE A4

4.4.5.1 Executive, Letter, Legal, Ledger, A4, or A3

Selectable page sizes available are as follows: **Executive, Letter, Legal, Ledger, A4, and A3.**

Key Path: **Print Setup, Page Size**

State Saved: Persistent, survives **Preset** and power cycle, but not saved in Instrument State.

Factory Preset: Letter

Remote Command:

```
:HCOpy:IMAGe:COLor[:STATe] OFF|ON|0|1
```

```
:HCOpy:IMAGe:COLor[:STATe]?
```

Example: HCOP:IMAG:COL ON

4.4.6 Color

Allows you to select between color or black and white printing on color-capable printers. This key is inactive (greyed out) if **Color Capable** is set to **No**, see [page 230](#).

Key Path: **Print Setup**

State Saved: Persistent, survives **Preset** and power cycle, but not saved in Instrument State.

Factory Preset: Off

Remote Command:

```
:HCOpy:IMAGe:COLor[:STATe] OFF|ON|0|1
```

```
:HCOpy:IMAGe:COLor[:STATe]?
```

Example: HCOP:IMAG:COL ON

4.5 Save

Saves analyzer states, traces, and screen data to a floppy (A:) drive or internal flash memory (C:) drive, as configured by the **File** menu. For example, if you have configured the instrument to save a trace to the C: drive, every time you press **Save**, it will save the current trace to a file with a new default trace file name.

You must first configure the save file **Type**, **Format**, **Source**, and **Destination** by using **File**, **Save** before pressing the front-panel **Save** key. Pressing the front-panel **Save** key will then be the same as pressing **File**, **Save**, **Save Now**.

Key Path: Front-panel key

Remote Command:

See “File” on page 127.

Use :MMEMory:STORe:SCReen <"file_name">

Use :MMEMory:STORe:STATe 1,<"file_name">

Use :MMEMory:STORe:TRACe <label>,<"file_name">

Use :MMEMory:STORe:LIMIt LLINE1|LLINE2,<"file_name">

Use :MMEMory:STORe:CORRection ANTenna|CABLe|OTHer|USER,<'file_name'>

4.6 SPAN / X Scale

Activates the Span function and displays the menu of span functions.

4.6.1 Span

Changes the displayed frequency range symmetrically about the center frequency. Setting the span to 0 Hz puts the analyzer into zero span.

Key Path: **SPAN X Scale**

Dependencies/

Couplings: Span is coupled to center frequency. The maximum span may be limited by the center frequency setting.

State Saved: Saved in Instrument State

Factory Preset:

Model	Span
E4440A	26.49 GHz
E4443A	6.69 GHz
E4445A	13.19 GHz
E4446A	43.99 GHz
E4448A	49.99 GHz

Fundamental Units: Hz

Terminators: GHz, MHz, kHz, Hz

Default Terminator: Hz

Range:

Model	0 Hz, Span Range
E4440A	10 Hz to 26.5 GHz
E4443A	10 Hz to 6.7 GHz
E4445A	10 Hz to 13.2 GHz
E4446A	10 Hz to 44.0 GHz
E4448A	10 Hz to 50.0 GHz

Remote Command:

[:SENSe] :FREQuency:SPAN <freq>

[:SENSe] :FREQuency:SPAN?

Example: FREQ:SPAN 2 GHZ

4.6.2 Span Zoom

Turns on signal tracking and activates the span function. Entering a new span value will then change the span while keeping the marker used for signal tracking centered on the screen. Pressing **Span Zoom** is the same as pressing: **Frequency**, **Signal Track (On)**, and **Span**. See “[Signal Track](#)” on page 168.

Key Path: **SPAN X Scale**

State Saved: Saved in Instrument State

Remote Command:

No equivalent SCPI command.

4.6.3 Full Span

Changes the displayed frequency span to show the full frequency range of the analyzer. When using external mixing, it changes the displayed frequency span to the frequency range specified for the selected external mixing band.

Key Path: **SPAN X Scale**

Remote Command:

[:SENSe] :FREQuency:SPAN:FULL

Example: FREQ:SPAN:FULL

4.6.4 Zero Span

Changes the displayed frequency span to zero Hertz. The horizontal axis changes to time rather than frequency. The input signal that is at the current center frequency is the displayed amplitude. This is a special operation mode that changes several measurement functions/couplings. The instrument behavior is similar to an oscilloscope with a frequency selective detector installed in front of the oscilloscope. See Application Note 150 for more information on how to use this mode.

Key Path: SPAN X Scale

Remote Command:

See [:SENSe]:FREQuency:SPAN 0 Hz

Example: FREQ:SPAN 0 Hz

4.6.5 Last Span

Changes the displayed frequency span to the previous span setting. If it is pressed immediately after **Signal Track** or **Span Zoom** is turned off, then span setting returns to the span that was in effect before these function were turned on.

Key Path: SPAN X Scale

Remote Command:

[:SENSe]:FREQuency:SPAN:PREVious

Example: FREQ:SPAN:PREV

4.7 SWEEP

Activates the **Sweep Time** function and displays the sweep function menu keys.

Key Path: Front-panel key

4.7.1 Sweep Time

Selects the length of time in which the spectrum analyzer sweeps the displayed frequency span. In swept spans, the sweep time varies from 1 millisecond to 2000 seconds plus time for setup which is not calculated as part of the sweep time. Reducing the sweep time increases the rate of sweeps. In zero span, the sweep time may be set from 1 μ s to 6000 s. In FFT spans, the sweep time is not controlled by the user, but is an estimate of the time required to make FFT measurements. Sweep time is coupled to RBW and VBW, so changing those parameters may change the sweep time. When the analyzer has been set to FFT, **Sweep Time**, and **Auto Sweep Time** are disabled (greyed out).

You may select a sweep time less than the auto-coupled value; however this may generate measurement errors. If this happens, the error message: Meas Uncal will appear in the upper right corner of the display.

NOTE In zero span or FFT sweeps, the auto/manual function of this key is not applicable. When **Sweep Time (Auto)** is selected in non-zero span, any changes to Sweep Time while in zero span will revert to the Auto value when you return to non-zero span. When **Sweep Time (Man)** is selected in non-zero span, any changes to Sweep Time while in zero span will be maintained when you return to non-zero span (within the available sweep time range). When entering zero span from a non-zero span, the sweep time does not change.

Key Path: **Sweep**

Annunciation/

Annotation: The sweep is displayed in the lower-right corner of the screen. Also, the points displayed parenthetically.

State Saved: Saved in Instrument State

Factory Preset: Auto

Model	Sweep Time
E4440A	66.24 ms
E4443A	11.16 ms
E4445A	22.00 ms
E4446A	110.00 ms
E4448A	125.00 ms

Default Terminator: seconds

Range: in zero span: 1 μ s to 6000s
 in swept spans: 1 ms to 2000s

Remote Command:

```
[ :SENSe ] :SWEep:TIME <time>  
[ :SENSe ] :SWEep:TIME?  
[ :SENSe ] :SWEep:TIME:AUTO OFF|ON|0|1  
[ :SENSe ] :SWEep:TIME:AUTO?
```

Example: SWE:TIME 500 ms
 SWE:TIME:AUTO OFF

4.7.2 Sweep

Switches the analyzer between continuous-sweep and single-sweep mode. Pressing the front-panel Single key will also put the analyzer in single-sweep mode, then take a sweep.

Key Path: **Sweep**
State Saved: Saved in instrument state
Factory Preset: Continuous

Remote Command:

```
:INITiate:CONTinuous OFF|ON|0|1  
:INITiate:CONTinuous?  
:INITiate:[IMMediate]
```

Remote Command Notes: This command affects sweep if not in a measurement, and affects trigger when in a measurement. A “measurement” refers to any of the functions under the **MEASURE** key. This corresponds to continuous sweep or single sweep operation when not in a measurement, and continuous measurement or single measurement operation when in a measurement.

When NOT in a measurement, this command does the following:

- When ON at the completion of each sweep cycle, the sweep system immediately initiates another sweep cycle.
- When OFF, the sweep system remains in an “idle” state until CONTinuous is set to ON or an :INITiate:[IMMediate] command is received. On receiving the :INITiate:[IMMediate] command, it will go through a single sweep cycle, and then return to the “idle” state.

- The query returns 1 or 0 into the output buffer. 1 is returned when there is continuous sweeping. 0 is returned when there is only a single sweep.

When in a measurement, this command does the following:

- When ON at the completion of each trigger cycle, the trigger system immediately initiates another trigger cycle.
- When OFF, the trigger system remains in an “idle” state until CONTinuous is set to ON or an :INITiate[:IMMEDIATE] command is received. On receiving the :INITiate[:IMMEDIATE] command, it will go through a single trigger cycle, and then return to the “idle” state.
- The query returns 1 or 0 into the output buffer. 1 is returned when there is continuous triggering. 0 is returned when there is only a single trigger.

Use the :TRIGger [:SEQuence] :SOURce command to select the trigger source.

Example: INIT:CONT OFF

4.7.3 Auto Sweep Time

Switches the analyzer between normal and accuracy sweep states. Provides you the ability to select the rules for the control of sweep time when **Sweep Time** is set to **Auto**. Setting **Auto Sweep Time** to **Accy** will result in slower sweep times, usually about three times as long, but better amplitude accuracy for CW signals. The instrument specifications only apply when **Sweep Time** is set to **Auto**, and **Auto Sweep Time** is set to **Accy**.

Additional amplitude errors occur when **Auto Sweep Time** is set to **Norm** are usually well under 0.1 dB, though they are not guaranteed. Because of the faster sweep times and still low errors, **Norm** is the preferred setting of **Auto Sweep Time**. Also, when the **Auto All** function is performed, **Auto Sweep Time** is set to **Norm**.

Key Path: **Sweep**

Key Notes: Greyed out in Zero Span and FFT, but still shows user selected states (Norm or Accy). Goes to Norm on Auto All.

Dependencies/

Couplings: Key is greyed out in Zero Span and FFT, but still shows user selected states (Norm or Accy). Goes to Norm on Auto All.

State Saved: Save

Factory Preset: Norm

Remote Command:

```
[ :SENSE ] :SWEep:TIME:AUTO:RULEs NORMal |ACCuracy
```

```
[ :SENSe ] :SWEep:TIME:AUTO:RULEs?
```

Example: SWE:TIME:AUTO:RUL ACC

4.7.4 Points

Sets the number of points per sweep, from 101 to 8192 in non-zero span and 2 to 8192 in zero span. Resolution of setting the sweep time will depend on the number of points selected. If **Factory Preset** is selected, or the analyzer power is cycled, the number of points per sweep will default to 601. The current value of points is displayed parenthetically, next to the sweep time in the lower-right corner of the display (refer to “Display Annotation” in your Getting Started guide).

Changing the number of points has several effects on the analyzer. Since markers are read at the point location, the marker reading may change. All trace data for the active trace is cleared. If sweep is set to **Cont** (press **Sweep, Sweep**), a new sweep begins immediately. If average is set to **On** (press **BW/Avg, Average**), the averaging starts over with a count of 0. If limit lines are set to **On** (press **Display, Limits, Modify, Limit 1 or 2**), the limit lines are updated.

NOTE By selecting a number of sweep points greater than 601, you are optimizing frequency resolution and accuracy while accepting a reduced measurement speed. In addition to sweep points, the span, resolution bandwidth, video bandwidth, average detection and center frequency will also affect measurement speed.

This function is coupled with the span setting. Increasing the span can change the number of sweep points. In order to maintain accurate measurements, the number of sweep points is increased if required to keep the width of each sweep point at most 150 MHz.

When zone span is set to **On** (press **Span, Zone. Zone**), each window has its own value for points.

Key Path: **Sweep**

Dependencies/

Couplings: Affected by: log sweep, segmented sweep

Affects the following functions: whenever the number of sweep points change:

- All trace data is erased
- Any traces in view mode will go to blank mode
- Sweep time is re-quantized
- Any limit lines that are on will be updated

State Saved: Saved in instrument state

Factory Preset: 601

Range: 101 to 8192, 2 to 8192 in zero span

Remote Command:

[:SENSe] :SWEep :POINts <number of points>

[:SENSe] :SWEep :POINts?

Example: SWE:POIN 501

 SWE:POIN?

4.8 System

Displays the **System** menu keys to control overall **System** functions. This is also the GPIB “LOCAL” key. Pressing **System** after the analyzer has been placed in the remote GPIB mode returns it to the local mode and enables front-panel control. During GPIB operation, “R” appears in the upper-right corner of the display indicating the instrument is in Remote mode. A “T”, “L,” or “S” may appear during remote operation, indicating Talk, Listen, or Service request. Pressing the **System (Local)** key removes the R symbol in the upper-right corner.

Symbol	Description
R	Remote
T	Talk
L	Listen
S	Service Request

Key Path: Front-panel key

Remote Command:

There is no remote command for this key.

4.8.1 Show Errors

Accesses a display of the last 30 (?) errors reported. The most recent error will appear at the top of the list. The first error listed will be the first error removed if the error list is longer than 30 entries. If the same error message occurs several times the error message will be incremented rather than added to the list as a new error message. If there is more than one of the same type of error, the date and time identify the first time and the last time an error occurred and the number of identical errors is shown.

NOTE A continuous recurring error reappears in the queue even if it had been cleared.

Key Path: **System**

Annunciation/

Annotation: Textual Information Screen

Dependencies/

Couplings: Removes any active functions.

Saved State: Not saved in instrument state.

Factory Preset: Off

Remote Command:

:SYSTem:ERRor [:NEXT] ?

Remote Command Notes: The :SYSTem:ERRor [:NEXT] ? command queries the earliest entry to the error queue and then deletes that entry.

Example: SYST:ERR? returns <error number>,<"error string">, for example -113,"Undefined header".

*CLS clears the entire error queue.

4.8.1.1 Previous Page

Displays the previous page of the Show Errors screen. This key is inactive (greyed out) if there is no previous page.

4.8.1.2 Next Page

Displays the next page of the Show Errors screen. This key is inactive (greyed out) if there is no next page.

4.8.1.3 Clear Error Queue

Clears the front-panel error queue from the **Show Errors** display.

Key Path: **System, Show Errors**

Remote Command:

*CLS

4.8.2 Power On/Preset

Displays keys that enable you to define the instrument power-on state and user preset state.

NOTE If **Power On** is set to **Preset**, and **Preset Type** is set to **Factory**, turning on the analyzer performs a factory preset. The last state of the analyzer (before it was turned off) is recalled if **Power On** is set to **Last**. The user preset state is recalled if **Power On** is set to **Preset** and **Preset Type** is set to **User**. (However, if there is no user preset state saved, the analyzer performs a factory preset.)

Key Path: **System**

4.8.2.1 Power On

Enables you to set the state the analyzer will be put in when it is powered on. You can set the state to Last or Preset.

If **Power On** is set to Last, then the instrument returns to the last saved instrument state and all the modes are restored to that last state. The instrument saves its current state internally every 2 minutes. So the last saved state, that is restored at power-on, is the state at power-off or within a maximum of two minutes before power-off.

If **Power On** is set to Preset, the instrument state is determined by the preset type setting prior to turning the power off.

- Preset type Factory powers on in the Spectrum Analysis mode and all modes are set to their factory defaults.
- Preset type Mode powers on with the last mode the analyzer was in when it was powered off and presets that mode to the factory defaults. It also restores all other modes to their factory preset.
- Preset type User powers on with the user defined state, saved when a **Save User Preset** was last performed.

The setting (Last or Preset) of the Power On function is not changed by pressing **Preset**. Use the **Power On/Preset** menu key function to change the setting of the analyzer state that is recalled at power on. Limit lines are not recalled when the analyzer is powered on. Refer to “Preset” on page 221 for more information.

Key Path: **System, Power On/Preset**

State Saved: Survives **preset** and power cycle, but not saved in Instrument State.

SCPI Status Bits/

OPC Dependencies: None

Remote Command:

```
:SYSTem:PON:TYPE PRESet | LAST
```

```
:SYSTem:PON:TYPE?
```

Example: SYST:PON:TYPE LAST defines the power on type as the last state the analyzer was in before power was turned off.

```
SYST:PON:TYPE?
```

4.8.2.2 Preset Type

Enables you to select what type of preset will be initiated when you press the green **Preset** key or send the remote command, using `SYST:PRES`. Choose between `Factory`, `Mode`, or `User defined` presets.

Key Path: **System, Power On/Preset**

State Saved: Survives **Preset** and power cycle, but is not saved in Instrument State.

SCPI Status Bits/

OPC Dependencies: None

Preset: Does not change the Preset Type.

Factory

Default: Mode

Remote Command:

```
:SYSTem:PRESet:TYPE FACTory|USER|MODE
```

```
:SYSTem:PRESet:TYPE?
```

Remote Command Notes: `SYSTem:PRESet:USER:SAVE` defines the user preset.

Example: `SYST:PRES:TYPE FACT` defines the type of preset as the factory preset.

4.8.2.2.1 User

Sets the preset type to **User**. When you do a preset, the instrument state that you have defined as the user preset setting will be restored. Use the **Save User Preset** key to define your user preset settings. Refer to “[Preset](#)” on page 221 for more information. If you have not saved a user state, then the instrument will save the power-up state for you to use as a default user preset state.

Key Path: **System, Power On/Preset, Preset Type**

Readback: User

Annunciation/

Annotation: None

State Saved: Survives **Preset** and power cycle, but no saved in Instrument State.

SCPI Status Bits/

OPC Dependencies: None

Factory

Default: Mode

Remote Command:

See “[Preset Type](#)” on page 250.

Example: `SYST:PRES[:USER]:SAVE` saves the current state to be used as the preset

user state.

SYST:PRES:TYPE USER defines the type of preset as the user preset.

With user preset selected, and a user state saved, use SYST:PRES to do a user preset.

4.8.2.2.2 Mode

Sets the preset type to “Mode.” When you do a preset, the current mode factory default instrument state will be restored. A mode preset does not change the mode. Refer to “Preset” on page 221 for more information.

Key Path: **System, Power On/Preset, Preset Type**

Readback: Mode

Annunciation/

Annotation: None

Dependencies/

Couplings: None

State Saved: Survives **Preset** and power cycle, but no saved in Instrument State.

SCPI Status Bits/

OPC Dependencies: None

Factory

Default: Mode

Remote Command:

:SYSTem:PRESet:TYPE See “Preset Type” on page 250.

Example: SYST:PRES:TYPE MODE defines the type of preset as the mode preset.

After you have selected mode as the preset type, use SYST:PRES to do a mode preset.

4.8.2.2.3 Factory

Sets the preset type to “Factory.” When you do a preset, all of the factory default instrument state will be restored. A factory preset switches the analyzer to the Spectrum Analysis mode and resets the settings of all the modes to the factory defaults (i.e. Spectrum Analysis Mode with continuous sweep). Refer to “Preset” on page 221 for more information.

Key Path: **System, Power On/Preset, Preset Type**

Annunciation/

Annotation: Factory

State Saved: Survives **Preset** and power cycle, but not saved in Instrument State.

Factory

Default: Mode

Remote Command:

See “Preset Type” on page 250.

Example: SYST:PRES:TYPE FACT defines the type of preset as the factory preset.
With factory preset selected, use SYST:PRES to do a factory preset.

4.8.2.3 Save User Preset

Saves the current state of the analyzer into the **User Preset** state register for recall when the instrument Preset Type is set to User and you perform a preset operation. After you save a state here, you must go to the **Preset Type** key and select **User** in order to have this state used as the preset state. Refer to “Preset” on page 221 key description for the default factory-configuration settings.

Key Path: **System, Power On/Preset**
Preset, if the preset type is set to User. See “Save User Preset” on page 225

Annunciation/
Annotation: None

Dependencies/
Couplings: None

SCPI Status Bits/
OPC Dependencies: None

Remote Command:

:SYSTem:PRESet [:USER] :SAVE

Example: SYST:PRES:SAVE
Use SYST:PRES:TYPE USER to set factory preset type to “User.”
Then use SYST:PRES to do the preset.

4.8.3 Time/Date

Displays the Time/Date function menu keys used to set and display the real-time clock.

Key Path: System

Remote Command:

There is no remote command for this key.

4.8.3.1 Time/Date

Turns the display of the real-time clock on or off.

Key Path: **System, Time/Date**

Annunciation/

Annotation: Current time and date are displayed in the upper-left corner of the screen.

State Saved: Survives **Preset** and power cycle, but not saved in Instrument State.

SCPI Status Bits/

OPC Dependencies: None

Factory

Default: On (Restored by **System, Restore Sys Defaults.**)

Remote Command:

```
:DISPlay:ANNotation:CLOCk[:STATe] ON|OFF
```

```
:DISPlay:ANNotation:CLOCk[:STATe]?
```

Example: DISP:ANN:CLOC ON

4.8.3.2 Date Format

Enables you to set the date display to month-day-year or day-month-year. It is set to a month-day-year format when the instrument System Defaults are restored. This key only effects display of date at the top of the screen, not in the file catalog.

Key Path: **System, Time/Date**

State Saved: Survives **Preset** and power cycle, but not saved in Instrument State.

SCPI Status Bits/

OPC Dependencies: None

Factory

Default: MDY (Restored by **System, Restore Sys Defaults.**)

Remote Command:

```
:DISPlay:ANNotation:CLOCk:DATE:FORMat MDY|DMY
```

```
:DISPlay:ANNotation:CLOCk:DATE:FORMat?
```

Example: DISP:ANN:CLOC:DATE:FORM DMY

4.8.3.3 Set Time

Enables you to set the time of the real-time clock. Enter the time in 24 hour HHMMSS format.

Key Path: **System, Time/Date**

Dependencies/

Couplings: None

State Saved: Survives **Preset** and power cycle, but not saved in Instrument State.

SCPI Status Bits/

OPC Dependencies: None

Factory

Default: Not affected by “**Restore Sys Defaults.**”

Terminators: Unitless

Default Terminator: None

Range: Hour (HH): 00 to 23.

Minute (MM): 00 to 59.

Second (SS): 00 to 59.

Remote Command:

:SYSTem:TIME <hour>, <minute>, <second>

:SYSTem:TIME?

Example: SYST:TIME 12, 42, 00 Sets the clock to 12:42:00 PM.

4.8.3.4 Adjust Time Setting (Remote Command Only)

Adjust the instruments internal time by the value entered.

Key Path: **System, Time/Date**

SCPI Status Bits/

OPC Dependencies: None

Terminators: No units are allowed with the command.

Default Terminator seconds

Remote Command:

:SYSTem:TIME:ADJust <seconds>

Example: SYST:TIME:ADJ 3600 will advance the time one hour.

SYST:TIME:ADJ -86400 will back the date up one day, without changing the time of day (minutes or seconds).

4.8.3.5 Set Date

Allows you to set the date of the real-time clock. Enter the date in the YYYYMMDD format.

Key Path: **System, Time/Date**

State Saved: Survives **Preset** and power cycle, but not saved in Instrument State nor

restored by **System, Restore Sys Defaults.**

SCPI Status Bits/
OPC Dependencies: None

Factory

Default: Not affected by “**Restore Sys Defaults.**”

Terminators: Unitless

Range: Year (YYYY): 1970 to 2029

Month (MM):01 to 12

Day: 01 to 30 or 31 (depending on the month)

Remote Command:

:SYSTem:DATE <year>, <month>, <day>

:SYSTem:DATE?

Example: SYST:DATE 2000,12,24 Sets the date to December 24, 2000

4.8.4 Alignments

Displays functions that control the automatic alignment of the instrument and load default values for the alignment system.

NOTE Most CALibration commands execute in the background, permitting other SCPI commands to be processed concurrently. If a measurement command is sent right after a CALibration command, there can be interaction between background alignments and the measurement. The *WAI command should be issued after any CALibration command and before the measurement command. Note that sending the query form of a CAL? command will automatically hold off any following commands until the query value is returned.

Bit 0 (CALibration) must be set to 1 in the STATus:OPERation:ENABLE register to ensure that the *WAI command waits for calibration to complete. This is the factory preset and *RST setting.

Key Path: System

Remote Command:

There is no remote command for this key.

4.8.4.1 Auto Align

Allows you to turn the instrument automatic alignment **On** or **Off**. or select **Alert** to be

alerted that alignments are needed.

- **Off**, the instrument won't initiate any* visible alignments or alerts.
- **All**, turns on the automatic alignment of all measurement systems. When **Auto Align**, **All** is selected, "**AA**" appears along the left edge of the display.
- **Alert**, a 3 degree (Celsius) temperature change or a time span of 24 hours since the last successful Full alignment (e.g., **Align All Now**) will trigger an alert that alignments need to be done, but no alignments will be performed without user input. When **Auto Align Alert** is selected "**AL**" appears along the left edge of the display.
- **All but RF**, turns on the automatic alignment of all measurement systems except the RF section. (Eliminating automatic alignment of the RF prevents changes in the input impedance between sweeps, which could cause input device instability.) When **Auto Align**, **All but RF** is selected, "**AB**" appears along the left edge of the display.
- **On**, the instrument behaves like the **Alert**, but will automatically perform a full alignment when it is needed. In addition, every 15 minutes passing or 1.5 degrees temperature change will cause just the RF system gain to be aligned, to achieve the best absolute amplitude accuracy. For either alignment, the instrument will stop any measurement currently in process, perform the full alignment, then restart the measurement from the beginning (similar to pressing **Restart**). If any alignment FAILs or is ABORTed by the user (e.g. ESCape key), the instrument will wait 5 minutes before retrying the necessary alignment. This helps to avoid infinite recursive loops of alignment behavior in the event of broken hardware. Also see "[Align All Now](#)" on page 257.

* There are 2 very quick alignments, invisible to the user, that are done every few minutes or when certain settings are changed. These still occur, even if **AutoAlign** is set to **Off**. These alignments are the Current SysGain and Current IF Flatness methods which can also be forced to occur by user under the Align Subsys menu.

Key Path: **System, Alignments**

State Saved: Survives **Preset** and power cycle, but not saved in Instrument State.

Factory Preset: Not affected by **Preset**.

Factory

Default: On (Restored by System, Restore Sys Defaults.)

Remote Command:

```
:CALibration:AUTO OFF|ON|ALERT
```

```
:CALibration:AUTO?
```

Example: CAL:AUTO ON

4.8.4.2 Align All Now

Accesses the **Align Now** menu keys and immediately executes an alignment cycle of all the subsystems (**Align RF**, **Align IF**, **Align ADC**, and **Align Current Sys Gain**). The instrument will stop any measurement currently underway, perform the full alignment, then restart the measurement from the beginning (similar to pressing the **Restart** key). All other operations are stopped and the alignments will be visible on the display.

Key Path: System, Alignments

Remote Command:

```
:CALibration[:ALL] Performs a full alignment.
```

The following three commands perform a full alignment and return a number indicating the success of the alignment. A zero is returned if the alignment is successful. A one is returned if any part of the alignment fails.

```
:CALibration[:ALL]?
```

```
*CAL?
```

```
*TST?
```

Example: CAL? The query performs a full alignment and returns a number indicating the success of the alignment. A zero is returned if the alignment is successful.

4.8.4.3 Frequency Corrections (Remote Command Only)]

Turns the internal frequency corrections on/off.

Saved State: Not saved in instrument state

Factory Preset: On

Factory
Default: On

Remote Command:

:CALibration:FREQuency[:STATE] OFF|ON|0|1

:CALibration:FREQuency[:STATE]?

Example: CAL:FREQ OFF

4.8.4.4 Align Subsys

Displays keys that enable you to activate a partial alignment.

Key Path: System, Alignments

Remote Command:

There is no remote command for this key.

4.8.4.4.1 Align RF

Initiates an alignment on the RF assembly.

Key Path: **System, Alignments, Align Subsys**

Annunciation/

Annotation: Will display a series of pop-up message boxes, indicating an alignment is in progress.

If a signal is present which interfere with the alignment a message Align RF 50 MHz signal detected. will be displayed.

SCPI Status Bits/

OPC Dependencies: Status questionable calibration. Bits 3, 11, or 12 will be set if Align RF fails

Remote Command:

:CALibration:RF

:CALibration:RF?

Remote Command Notes: The query performs the alignment and returns a zero if the alignment is successful.

Example: CAL:RF?

4.8.4.4.2 Align IF

Initiates an alignment on the IF assembly.

Key Path: **System, Alignments, Align Subsys**

Annunciation/

Annotation: Will display a series of pop-up message boxes indicating alignment progress.

SCPI Status Bits/

OPC Dependencies: Status questionable calibration Bit 4 will be set if Align RF fails.

Remote Command:

:CALibration:IF

:CALibration:IF?

Remote Command Notes: The query performs the alignment and returns a zero if the alignment is successful.

Example: CAL:IF?

4.8.4.4.3 Align ADC

Initiates an alignment on the ADC circuitry.

Key Path: **System, Alignments, Align Subsys**

Annunciation/

Annotation: Message boxes indicating alignment of ADC progress.

SCPI Status Bits/

OPC Dependencies: Status questionable calibration Bit 6 will be set if Align ADC fails.

Remote Command:

:CALibration:ADC

:CALibration:ADC?

Remote Command Notes: The query performs the alignment and returns a zero if the alignment is successful.

Example: CAL:ADC?

4.8.4.4.4 Align Current IF Flatness

Initiates an alignment of the current IF flatness, for the purpose of improving absolute amplitude within FFT Sweeps and improving group delay in some digital demodulation measurements.

Key Path: **System, Alignments, Align Subsys**

Annunciation/

Annotation: Will display a series of pop-up message boxes explaining what is being

aligned (a subset of the Align All Now message boxes).

Remote Command:

:CALibration:FLATness:IF

:CALibration:FLATness:IF?

Remote Command Notes: The query performs the alignment and returns a zero if the alignment is successful.

Example: CAL:FLAT:IF?

4.8.4.4.5 Align Current SysGain

Initiates a fine-tuning adjustment of the system gain, primarily to correct for small amplitude variations that occur as resolution BW is switched.

Key Path: **System, Alignments, Align Subsys**

Annunciation/

Annotation: Will display a series of pop-up message boxes explaining what is being aligned (a subset of the Align All Now message boxes).

Remote Command:

:CALibration:GAIN:CSYSem

:CALibration:GAIN:CSYSem?

Remote Command Notes: The query performs the alignment and returns a zero if the alignment is successful.

Example: CAL:GAIN:CSYS?

4.8.4.5 Restore Align Defaults

Loads the default values for the alignment system, turns on the frequency corrections, and resets the timebase to the factory values. **Align All Now** must be executed 3 times after pressing **Restore Align Defaults** to meet specifications.

Key Path: **System, Alignments**

Annunciation/

Annotation: System Alignments, Align Now All required.

Dependencies/

Couplings: None

SCPI Status Bits/

OPC Dependencies: Status questionable calibration Bit 14 will be set.

Remote Command:

:CALibration:DATA:DEFault

Example: CAL:DATA:DEF

4.8.4.6 Set Calibration Display Detail (Remote Command Only)

Controls the amount of detail shown on the display while the alignment routines are running. The routines run faster if the display level is off, so they do not have to update the display.

Off - displays no trace points

Low - displays every 10th trace

High - displays every trace

Factory Preset: Low

Remote Command:

```
:CALibration:DISPlay:LEVel OFF|LOW|HIGH
```

```
:CALibration:DISPlay:LEVel?
```

Example: CAL:DISP:LEV HIGH

4.8.4.7 Select Time Corrections (Remote Command Only)

Controls time corrections used to compensate for the complex (magnitude and phase) response of the analog and digital IF hardware. When only scalar (magnitude) FFT flatness is required, time corrections take more CPU cycles and so are less efficient than frequency corrections. For demod or other time-based (not FFT) measurements, only time corrections can improve the flatness that results from imperfect IF hardware. When the time correction functionality is set to Auto (the default), the individual measurements activate the corrections when they are needed.

NOTE Turning time corrections on or off effects all measurements. Time corrections should be left in Auto unless you have specific reasons for forcing them on or off.

Always return time corrections to Auto.

Factory Preset: Auto

Remote Command:

```
:CALibration:TCORrections AUTO|ON|OFF
```

Example: CAL:TCOR OFF

4.8.5 Config I/O

Displays the keys and menus that enable you to identify and change the current GPIB address and LAN settings.

Key Path: System

Remote Command:

There is no remote command for this key.

4.8.5.1 GPIB Address

Shows the current GPIB address and allows you to change this value using the numeric keyboard. The new value is displayed in the active function area. The GPIB port is always active. The knob and step keys are not active for this function.

Key Path: **System, Config I/O**

State Saved: Survives **Preset** and power cycle, but not saved in Instrument State.

SCPI Status Bits/

OPC Dependencies: None

Factory

Default: 18 (Reset by **System, Restore Sys Defaults.**)

Terminators: Enter

Default Terminator: None

Resolution/Rounding/

Truncation: Integer

Knob Increment: 1

Step Key

Increment: 1

Range: 0 to 30

Remote Command:

```
:SYSTem:COMMunicate:GPIB[:SELF]:ADDRess <integer>
```

```
:SYSTem:COMMunicate:GPIB[:SELF]:ADDRess?
```

Example: SYST:COMM:GPIB:ADDR 20

4.8.5.2 IP Address

Allows you to set the IP (internet protocol) address, domain name and node (host) name for the instrument. The IP address of the instrument can be changed by entering a numeric address composed of numbers and decimal points. Press **ENTER** to complete the entry.

Key Path: **System, Config I/O**

State Saved: Survives **Preset** and power cycle, but not saved in Instrument State.

Factory

Default: 199.199.199.199 (Not reset by **System, Restore Sys Defaults.**)

Remote Command:

```
:SYSTem:COMMunicate:LAN[:SELF]:IP <string>
```

```
:SYSTem:COMMunicate:LAN[:SELF]:IP?
```

Example: SYST:COMM:LAN:IP "150.222.50.52 mypsa"
 Sets the IP address to 150.222.50.52 and sets the host name to mypsa.

4.8.5.3 Host Name

Displays the host name of the instrument. Pressing the key activates the alpha editor, which enables you to change the host name. (Press **ENTER** to complete the entry.)

NOTE This will not change your LAN system representation of the host name. You must work through your local system administrator to change the host name. Changing it in the instrument only changes the displayed information, it will not enable LAN access with the new name.

Key Path: **System, Config I/O**
State Saved: Survives **Preset** and power cycle, but not saved in Instrument State.
Factory
Default: myspa (Not reset by **System, Restore Sys Defaults.**)

Remote Command:

See above command :SYSTem:COMMunicate:LAN[:SELF]:IP <string>

Example: SYST:COMM:LAN:IP "150.222.50.52 mypsa"
 Sets the IP address to 150.222.50.52 and sets the host name to mypsa.

4.8.5.4 Host ID (Remote Command Only)

Enables you to query the host ID remotely. The current value of the host ID can be viewed on the display by pressing **System, Show System**.

SCPI Status Bits/
OPC Dependencies: None

Factory
Default: Value is unique to your instrument (Not reset by **System, Restore Sys Defaults.**)

Remote Command:

:SYSTem:HID?

Remote Command Notes: The host ID cannot be set remotely, it can only be queried.

Example: SYST:HID?

4.8.5.5 Subnet Mask

Changes the subnet mask of the instrument. The subnet mask is a 32-bit address mask used in IP networks to indicate the bits of an IP address that are used for the subnet address. The default address is 255.255.0.0 for a class B network

Key Path: **System, Config I/O**

State Saved: Survives **Preset** and power cycle, but not saved in Instrument State.

Factory

Default: 255.255.0.0 (Not reset by **System, Restore Sys Defaults.**)

History: Added with firmware revision A.03.00.

Remote Command:

There is no equivalent remote command.

4.8.5.6 Gateway Address

Allows you to set the gateway address. The gateway address feature is used to manipulate the gateway used to reach the destination. The gateway address can be changed by entering a numeric address composed of numbers and decimal points. Press **ENTER** to complete the entry.

Key Path: **System, Config I/O**

State Saved: Survives **Preset** and power cycle, but not saved in Instrument State.

Factory

Default: 0.0.0.0 (Not reset by **System, Restore Sys Defaults.**)

History: Added with firmware revision A.03.00.

Remote Command:

There is no remote command for this key.

4.8.5.7 SCPI LAN

Displays keys to enable SCPI functionality over LAN. There are a number of different ways to send SCPI remote commands to the instrument over the LAN. It can be a problem to have multiple users simultaneously accessing the instrument over the LAN. These keys allow you to limit that somewhat by disabling the telnet socket and/or SICL capability.

Key Path: System, Config I/O

Remote Command:

There is no remote command for this key.

4.8.5.7.1 SCPI Telnet

Turns on/off the SCPI LAN telnet capability allowing you to limit SCPI access over LAN via telnet.

Key Path: **System, SCPI Lan**

State Saved: Survives **Preset** and power cycle, but not saved in Instrument State.

SCPI Status Bits/

OPC Dependencies: None

Factory

Default: On (Reset by System, Restore Sys Defaults.)

Remote Command:

```
:SYSTem:COMMunicate:LAN:SCPI:TELNet:ENABle OFF|ON|0|1
```

```
:SYSTem:COMMunicate:LAN:SCPI:TELNet:ENABle?
```

Example: SYST:COMM:LAN:SCPI:TELN:ENAB ON

4.8.5.7.2 SCPI Socket

Turns on/off the capability of establishing Socket LAN sessions. This allows you to limit SCPI access over LAN via socket sessions.

Key Path: **System, SCPI Lan**

State Saved: Survives **Preset** and power cycle, but not saved in Instrument State.

SCPI Status Bits/

OPC Dependencies: None

Factory

Default: On (Reset by System, Restore Sys Defaults.)

Remote Command:

```
:SYSTem:COMMunicate:LAN:SCPI:SOCKet:ENABle OFF|ON|0|1
```

```
:SYSTem:COMMunicate:LAN:SCPI:SOCKet:ENABle?
```

Example: SYST:COMM:LAN:SCPI:SOCK:ENAB ON

4.8.5.7.3 SICL Server

Turns on/off the SICL server capability, enabling you to limit SCPI access over LAN via the SICL server. (SICL IEEE 488.2 protocol.)

Table 4-1 SCPI Default Settings

Parameter	Description	Setting
Maximum Connections	The maximum number of connections that can be accessed simultaneously	5
Instrument Name	The name (same as the remote SICL address) of your analyzer	inst0
Instrument Logical Unit	The unique integer assigned to your analyzer when using SICL LAN	8
Emulated GPIB Name	The name (same as the remote SICL address) of the device used when communicating with your analyzer	gpib7
Emulated GPIB Logical Unit	The unique integer assigned to your device when it is being controlled using SICL LAN	8
Emulated GPIB Address	The emulated GPIB address assigned to your transmitter tester when it is a SICL server (the same as your GPIB address)	18

Instrument Functions: P - Z

Key Path: **System, SCPI Lan**

State Saved: Survives **Preset** and power cycle, but not saved in Instrument State.

SCPI Status Bits/

OPC Dependencies: None

Factory

Default: On (Reset by System, Restore Sys Defaults.)

Remote Command:

```
:SYSTem:COMMunicate:LAN:SCPI:SICL:ENABle OFF|ON|0|1
```

```
:SYSTem:COMMunicate:LAN:SCPI:SICL:ENABle?
```

Example: SYST:COMM:LAN:SCPI:SICL:ENAB ON

4.8.6 Reference

Displays functions that control the external frequency reference.

Key Path: System

Remote Command:

There is no remote command for this key.

4.8.6.1 Freq Ref

Specifies the frequency reference as being internal or external. If the frequency reference is specified as internal, the frequency of the reference is automatically identified as being 10 MHz. If the frequency reference is specified as external, you must enter the frequency of the external reference being used. If External Reference is selected, **Ext Ref** will appear on the right side of the display.

The frequency of an external frequency reference is not automatically detected. If an external frequency source is selected, the frequency of the source must be entered.

If Ext is selected, and you press **Freq Ref**, Ext will remain selected and the Ext reference frequency will become the active function. If **Freq Ref** is pressed again, Int will become selected (at 10 MHz). The Ext reference frequency is remembered and will be used again if Ext is selected.

If the external reference is missing or out of range, or the frequency reference is unlocked, the message “External reference missing or out of range”, will appear on the display.

Key Path: **System, Reference**

State Saved: Not Saved in Instrument State. Neither the external reference frequency nor the state of this function (Int or Ext) are affected by factory preset or power cycle. Reset to the factory default (Int, 10 MHz) by pressing **System, Restore Sys Defaults**.

Default: Internal, 10 MHz

Range: 1 MHz to 30 MHz

Remote Command:

```
[ :SENSE ] :ROSCillator:SOURce INTernal|EXTernal
```

```
[ :SENSe ] :ROSCillator:SOURce?
```

```
[ :SENSe ] :ROSCillator:EXTernal:FREQuency <value>
```

```
[ :SENSe ] :ROSCillator:EXTernal:FREQuency?
```

Example: Before switching to the external reference source, specify the frequency of the external reference that you plan to use.

ROSC:EXT:FREQ 20 MHz sets the external reference frequency to 20 MHz,

but does not select the external reference.

ROSC:SOUR EXT selects the external reference.

4.8.6.2 10 MHz Out

Switches the 10 MHz out signal on the rear panel of the analyzer on or off.

Key Path: **System, Reference**

State Saved: Not Saved in Instrument State. Not affected by factory preset or power cycle. Reset to the factory default (Off, 10 MHz) by pressing **System, Restore Sys Defaults**.

Remote Command:

```
[ :SENSe ] :ROSCillator:OUTPut [ :STATe ] OFF | ON | 0 | 1
```

```
[ :SENSe ] :ROSCillator:OUTPut [ :STATe ] ?
```

Example: ROSC:OUTP ON

4.8.7 Show System

Displays the number and description of the options installed in your instrument. It also displays the instrument model number, product number, serial number, ethernet address, host ID, firmware revision, revision date, options, and system statistics.

Key Path: **System**

Annunciation/

Annotation: Text Screen

Dependencies/

Couplings: Active function is disabled.

SCPI Status Bits/

OPC Dependencies: None

Factory Preset: Off

Remote Command:

*IDN? Returns four fields separated by commas:

- Manufacturer
- Model
- Serial number
- Firmware version

Example of returned string: Agilent Technologies,E4440A,US00000123,A.01.01

```
:SYSTem:OPTions?
```

```
*OPT?
```

Returns a string of all the installed instrument options. It is a comma separated list such as: BAC,BAH.

Example: *IDN?

*OPT?

4.8.8 Show Hdwr

Gives detailed information about the hardware installed on your instrument.

Key Path: **System**

Annunciation/

Annotation: Text screen

Dependencies/

Couplings: Active function is disabled

SCPI Status Bits/

OPC Dependencies: None

Factory Preset: Off

Remote Command:

:SYSTem:CONF:HARD ON|OFF

Example: SYST:CONF:HARD OFF

4.8.9 Color Palette

Displays the Color Palette menu keys that set the display screen attributes.

Key Path: **System**

SCPI Status Bits/

OPC Dependencies: None

State Saved: Not saved in Instrument State, survives **Preset**, and power cycle.

Preset: Not affected by **Preset**.

Factory

Default: Default

Remote Command:

There is no remote command for this key.

4.8.9.1 Default

Selects the factory default color palette.

Dependencies/

Couplings: None

Key Path: **System, Color Palette**

SCPI Status Bits/

OPC Dependencies: None

4.8.9.2 Vision Impair 1

Selects a special color scheme to accommodate color-deficient vision problems.

Key Path: **System, Color Palette**

SCPI Status Bits/

OPC Dependencies: None

Dependencies/

Couplings: None

Remote Command:

There is no remote command for this key.

4.8.9.3 Vision Impair 2

Selects a special color scheme to accommodate color-deficient vision problems.

Key Path: **System, Color Palette**

Dependencies/

Couplings: None

SCPI Status Bits/

OPC Dependencies: None

Remote Command:

There is no remote command for this key.

4.8.9.4 Optical Filter

Selects a special color scheme to accommodate protective goggles while viewing lasers.

Key Path: **System, Color Palette**

Dependencies/

Couplings: None

SCPI Status Bits/

OPC Dependencies: None

Remote Command:

There is no remote command for this key.

4.8.9.5 Monochrome

Sets the color palette to single-color mode. The monochrome display uses different shades of green for each green value. This is especially useful for driving external monochrome monitors.

Key Path: **System, Color Palette**

Dependencies/

Couplings: None

SCPI Status Bits/

OPC Dependencies: None

Remote Command:

There is no remote command for this key.

4.8.10 Diagnostics

Access front-panel diagnostic functions.

Key Path: **System**

Remote Command:

There is no remote command for this key.

4.8.10.1 Front Panel Test

Used to test the front-panel keys. It shows a list of all the front panel keys with counter numbers indicating the number times the key is pressed. Press the **ESC** key to exit the test mode and return to the menu.

Key Path: **System, Diagnostics**

Annunciation/

Annotation: Text Screen

Dependencies/

Couplings: The active function is disabled.

Factory Preset: Off

4.8.11 Restore Sys Defaults

Resets the system settings, including most “persistent” functions, to their factory defaults. It also does a Factory Preset that resets the analyzer to the Spectrum Analysis Mode. It does *not* reset user data such as saved instrument states.

Persistent functions are things such as the GPIB address, time/date display style, and auto-alignment state. These are parameters that are unaffected by a power cycle or an instrument preset.

Table 4-2 System Default Settings

Feature	Default Setting	Restored?
Automatic Alignment On/Alert/Off	On	yes
Power On Last/Preset	Preset	yes
Preset Type Factory/User/Mode	Mode	yes
External Amplifier Gain	0 dBm	yes
Input Impedance	50 Ohm	yes
GPIB Address	18	yes
IP address	10.10.10.10	no
Host Name	mypsa	no
Subnet Mask	255.255.0.0	no
SCPI Telnet Port 5023	On	yes
SCPI Socket Port 5025	On	yes
SICL Server	On	yes
Instrument Color Palette	Default palette	yes
Printer Setup, Language	PCL3	yes
Printer Setup, Color Capability	No	yes
Print Orientation	Portrait	yes
Color Printing	Off	yes
Prints/ Page	1	yes
Date Format	MDY	yes
Time Date Display	On	yes
Verbose (error messages)	Off	yes
Display Viewing Angle	4	yes
Manual Tracking Adjustment	2048	yes
Page Size	Letter	yes
Printer Selection	Auto	yes

Key Path: System

Remote Command:

:SYSTem:PRESet:PERSiStent

Example: SYST:PRES:PERS

4.8.12 Licensing

Accesses the security system to enable licensing for individual options. You can install a measurement mode personality options in an instrument at any time. After you load the personality mode into memory, you must enter a license key to allow access to the option.

For information on how to use this system, see the installation information for individual options in the measurement personalities' user's guides.

NOTE Not all options can be enabled using this system and there is no way to turn off an option through this system. Once an option has been licensed for a given analyzer, it cannot be transferred to a different analyzer.

Key Path: System

Remote Command:

There is no remote command for this key.

4.8.12.1 Option

Activates the alpha editor enabling you to enter the designation for the option to be installed. An option is a three character string that specifies the option or application that is to be installed, as found in the catalog. To terminate the entry, press **Enter** or **Return**. An external keyboard may also be used for this entry. The option number will appear on the second line of the **Option** key.

Key Path: **System, Licensing**

State Saved: Not saved in instrument state.

SCPI Status Bits/

OPC Dependencies: None

Remote Command:

See [“License Key” on page 277](#)

Example: SYST:LKEY "B78", "B62A35B37679"

SYST:LKEY? "B78"

4.8.12.2 License Key

Activates the alpha editor to allow you to enter the license key number for the option to be installed. The license key number is a hexadecimal number that will require entry of both letters and numbers. Use the front-panel numeric keyboard to enter numerical values. You will see your entry in the active function area. A license key is a 12-character hexadecimal string given with the option. The license key is unique to a specific option installed and instrument host ID. To terminate the entry, press **Enter** or **Return**. An external keyboard may also be used for this entry. The license key number will appear on the second line of the **License Key** menu key.

Key Path: **System, Licensing**

Dependencies/

Couplings: None

State Saved: Not saved in instrument state.

SCPI Status Bits/

OPC Dependencies: None

Factory Preset: Clears the current value.

Remote Command:

```
:SYSTem:LKEY <"option">, <"license key">
```

```
:SYSTem:LKEY? <"option">
```

Remote Command Notes: The query returns a string that contains the license key for a specified application or option that is already installed in the instrument. The license key will also be returned if the application is not currently in memory, but had been installed at some previous time. The license key is unique to a specific option, host ID and serial number. Host ID can be returned by :SYSTem:HID?.

Example: SYST:LKEY "B78", "B62A35B37679"

```
SYST:LKEY? "B78"
```

The query would return "B62A35B37679"

If the instrument does not have a license key for that option, the query would return "".

4.8.12.3 Activate License

Activates the specified option. When a valid option key number and license key number have been entered, press **Activate**. If your entry was correct, the option will be enabled and the message: `option activated` will appear in the status line of your display. The option number and license key number will also be cleared from the **License Key** and **Option** key.

If your entry was incorrect, the error message: `License key invalid` will appear in the status line of your display. The option number and license key number can be edited until

they are correct.

NOTE It is possible to enable an option for which the analyzer is not yet configured. Therefore, the message `Option activated` does not mean that the option will immediately function. For a display of options that are enabled and for which the analyzer is properly configured, press **System, More, Show System**.

Key Path: **System, Licensing**

Remote Command:

There is no remote command for this key.

4.8.12.4 Delete License

Deletes the license key from memory, however, the option firmware is not deleted.

Key Path: **System, Licensing**

Remote Command:

```
:SYSTem:LKEY:DELeTe <'application option'>,<'license key'>
```

Example: SYST:LKEY:DEL "BAC"

4.8.12.5 Show License

Displays the number and description of the licenses installed in your instrument.

Key Path: **System, Licensing**

Annunciation/

Annotation: Text Screen

Dependencies/

Couplings: The active function is disabled.

Remote Command:

There is no remote command for this function.

4.8.12.6 Install an Application Mode (Remote command only)

Installs the specified application from an external drive to the instrument. Each application allows you to make a specific set of measurements easily and accurately. Installation requires a 12-character license key that you received with your application. The license key number is unique to the option and instrument serial number. If it cannot be located, contact your local Agilent Technologies and service office to re-obtain the information. (Have the instrument model number, host ID, serial number available.)

Remote Command:

See also *OPT?

Example: *OPT? returns a string with all the application options currently installed in the instrument (e.g. "B7J,202,204,BAC").

4.8.13 Personality

Pressing **Personality** displays information about the personalities installed and their license status, as shown in the following illustration.

Option	Name	Version	Licensed	Size
	Power Suite Utilities	XA.04.00 Rev12	no	4610756
STD	BASIC	A.02.00rev05	std	2174840
BAC	cdmaOne	A.02.00rev05	yes	4091109
BAF	WCDMA	A.02.00rev05	yes	7945141
B78	CDMA2K	A.02.00rev05	yes	7558426
202	GSM w/EDGE	A.02.00rev05	yes	5486709
BAE	NADC	A.02.00rev05	yes	3350528
BAE	PDC	A.02.00rev05	yes	3465860

Key Path: **System**

Annunciation/

Annotation: Text Screen

Dependencies/

Couplings: The active function is disabled.

SCPI Status Bits/

OPC Dependencies: None

Factory Preset: Off

4.8.14 Service

These functions are used only for servicing the analyzer. A password is required to access them. Refer to the Service Guide for more information.

Key Path: **System**

4.8.15 Keyboard Lock (Remote Command Only)

Disables the instrument keyboard to prevent local input when instrument is controlled remotely. An annunciator reading “Klock” alerts the local user that the keyboard is locked. Or you can display a system message using SYSTem:MESSAge.

History: Added with firmware revision A.03.00

Remote Command:

:SYSTem:KLOCK?

Example: SYST:KLOCK?

4.8.16 Remote Message

Enables remote user to send message that will appear in the Status Bar at bottom of the instrument display. New message will overwrite any previous message. Message will remain until removed by use of :SYSTem:MESSAge:OFF.

Example: :SYSTem:MESSAge "Instrument currently in use remotely by
Ted in R+D"

Remarks: Message appears as green text against a black background to differentiate it from internally generated messages which appear as white text against a black background.

The SYSTem:KLOCK command will lock out the front panel keys.

History: Added with firmware revision A.03.00

Remote Command:

:SYSTem:MESSAge <string>

Example: :SYSTem:MESSAge "Instrument currently in use remotely by
Tom"

4.8.17 Remote Message Turned Off

Removes any system message from the Status Bar at the bottom of the instrument display. A message can be displayed using the `:SYSTem:MESSage` command.

History: Added with firmware revision A.03.00

Remote Command:

`:SYSTem:MESSage:OFF`

Example: `SYST:MESS:OFF`

4.8.18 Power On Elapsed Time (Remote Command Only)

Returns the number of seconds that have elapsed since the instrument was turned on for the very first time.

Remote Command:

`:SYSTem:PON:ETIMe?`

Example: `SYST:PON:ETIM?`

4.8.19 SCPI Version Query (Remote Command Only)

Returns the SCPI version number with which the instrument complies. The SCPI industry standard changes regularly. This command indicates the version used when creating the instrument SCPI commands.

Remote Command:

`:SYSTem:VERSion?`

Example: `SYST:VERS?`

4.9 Trace/View

Displays menu keys that enable you to set how trace information is stored and displayed. Each trace is comprised of a series of data points in which x and y axis information is stored. The analyzer updates the information for the active trace with each sweep.

NOTE If you have selected **ACP**, **Burst Power**, **Channel Power**, **Harmonic Distortion**, **Multi-Carrier Power**, **Power Stat CCDF**, or **Spectrum Emission Mask** in the **MEASURE** menu, refer to the **Trace/View** sections specific to those measurements.

Key Path: Front-panel key
Factory Default: Trace 1: Clear Write
Trace 2: Blank
Trace 3: Blank

Remote Command:

:TRACe [1] | 2 | 3 :MODE WRITe | MAXHold | MINHold | VIEW | BLANk

WRITe = **Clear Write**

MAXHold = **Max Hold**

MINHold = **Min Hold**

VIEW = **View**

BLANk = **Blank**

:TRACe [1] | 2 | 3 :MODE?

Example: TRAC:MODE WRIT
TRAC:MODE MAXH
TRAC:MODE MINH
TRAC:MODE VIEW
TRAC:MODE BLANk
TRAC:MODE?

4.9.1 Query Trace Data (Remote Command Only)

This query returns the current values of the designated trace amplitude values. The data is terminated with <NL><END>. (For GPIB this is newline, or linefeed, followed by EOI set true. For RS-232 this is newline only.)

The number of trace points returned is set by [:SENSE]:SWE:POIN (from 101 to 8192).

Factory Preset: Real,32 for Spectrum Analysis mode

History: Added with firmware revision A.02.00

Remote Command:

:TRACe[:DATA]? <trace_name>

<trace_name> is TRACE1|TRACE2|TRACE3

Remote Command Notes: The FORMat:DATA command describes the different types of data formats that can be used with trace data. See “Format Numeric Data (Remote Command Only)” on page 160.

Use the FORMat:BORDER command to set the byte order. See “Set Data Byte Order (Remote Command Only)” on page 160.

Commands :MMEM:STOR:TRAC and :MMEM:LOAD:TRAC are used to transfer trace data to/from the internal hard drive or floppy drive of the instrument. See “Save Now” on page 137 and “Load Now” on page 144.)

Example: TRAC? TRACE2 queries the analyzer for the contents of trace 2.

4.9.2 Trace

Determines which trace the menu keys will affect. Press **Trace** until the number of the desired trace is underlined.

Key Path: **Trace/View**

State Saved: Saved in Instrument State for all traces

Factory Preset: Trace 1 is active

Factory

Default: Trace 1 is active

History: Added with firmware revision A.02.00

Remote Command:

There is no remote command for this function.

4.9.3 Clear Write

Erases any data previously stored in the selected trace and continuously displays signals during the sweep of the analyzer.

Key Path: **Trace/View**

Remote Command:

See [“Trace/View” on page 283](#).

Example: `TRAC:MODE WRIT`

4.9.4 Max Hold

Maintains the maximum level for each trace point of the selected trace (1, 2 or 3), and updates each trace point if a new maximum level is detected in successive sweeps.

NOTE Pressing **Restart**, changing the vertical scale (**Amplitude, Scale Type**, Log or Lin) or turning averaging on (**BW/Avg, Average (On)**) restarts the held trace.

Key Path: **Trace/View**

Remote Command:

See [“Trace/View” on page 283](#).

Example: `TRAC:MODE MAXH`

4.9.5 Min Hold

Maintains the minimum level for each trace point of the selected trace (1, 2 or 3), and updates each trace point if a new minimum level is detected in successive sweeps.

NOTE Pressing **Restart**, changing the vertical scale (**Amplitude, Scale Type**, Log or Lin) or turning averaging on (**BW/Avg, Average (On)**) restarts the held trace.

Key Path: **Trace/View**

History: Added with firmware revision A.02.00

Remote Command:

See [“Trace/View” on page 283](#).

Example: `TRAC:MODE MINH`

4.9.6 View

Holds and displays the amplitude data of the selected trace. The trace is not updated as the analyzer sweeps.

Key Path: **Trace/View, Trace**

History: Added with firmware revision A.02.00

Remote Command:

See [“Trace/View” on page 283](#).

Example: `TRAC:MODE VIEW`

4.9.7 Blank

Stores the amplitude data for the selected trace and removes it from the display. The selected trace register will not be updated as the analyzer sweeps.

Key Path: **Trace/View**

History: Added with firmware revision A.02.00

Remote Command:

See [“Trace/View” on page 283](#).

Example: `TRAC:MODE BLAN`

4.10 Trig

Displays menu keys that enable you to select the trigger mode of a sweep or measurement. When in a trigger mode other than Free Run, the analyzer will begin a sweep only with the proper trigger condition.

In FFT measurements, the trigger controls when the data is acquired for FFT conversion; see “[Making Gated FFT Measurements With Your PSA](#)” on page 74.

Key Path: Front-panel key

State Saved: Saved in Instrument State

Factory Preset: Free Run

Remote Command:

```
:TRIGger[:SEquence]:SOURce  
IMMediate|VIDeo|LINE|EXTernal[1]|EXTernal2|RFBurst  
:TRIGger[:SEquence]:SOURce?
```

IMM = Free Run triggering

VID = Video—triggers on the video signal level

LINE = Line—triggers on the power line signal

Ext1 = External Front—enables you to trigger on an externally connected trigger source

Ext2 = External Rear—enables you to trigger on an externally connected trigger source

Remote Command Notes: Other trigger-related commands are found in the INITiate and ABORt subsystems.

Example: TRIG:SOUR VID

4.10.1 Free Run

Sets the trigger to start a new sweep/measurement as soon as the last one has ended (continuous sweep mode) or immediately (single sweep mode).

Key Path: Trig

Dependencies/

Couplings: Trigger Slope and Delay adjustments are not available with Free Run triggering.

Remote Command:

See “[Trig](#)” on page 287

Example: TRIG:SOUR IMM

4.10.2 Video

Activates the trigger condition that allows the next sweep to start if the detected RF envelope voltage crosses a level set by the video trigger level. When Video is pressed, a line appears on the display. The analyzer triggers when the input signal exceeds the trigger level at the left edge of the display. You can change the trigger level using the step keys, the knob, or the numeric keypad. The line remains as long as video trigger is the trigger type.

Key Path: **Trig**

Dependencies/

Couplings: Trigger Delay adjustment is not available with Video triggering.

Video triggering is not available when the detector is Average. Marker Functions that set the detector to average (such as Marker Noise or Band/Intvl Power) are not available when the video trigger is on.

This function is not available when the Resolution Bandwidth is less than 1 kHz. If a Resolution Bandwidth less than 1 kHz is selected while in Video Trigger mode, the Trigger mode changes to Free Run.

Factory Preset: -25 dBm

Range: Using *logarithmic scale*: from 10 display divisions below the reference level, up to the reference level

Using *linear scale*: from 100 dB below the reference level, up to the reference level

For more information, see [“Scale Type” on page 52](#).

Remote Command:

See [“Trig” on page 287](#) for the command that sets trigger mode. The following commands set/read the trigger level.

```
:TRIGger[:SEQuence]:VIDeo:LEVel <ampl>
```

```
:TRIGger[:SEQuence]:VIDeo:LEVel?
```

:TRIGger[:SEQuence]:VIDeo:LEVel:FREQuency <freq> sets the Video Trigger level when in FM Demod, and Demod View is on

```
:TRIGger[:SEQuence]:VIDeo:LEVel:FREQuency?
```

Example: TRIG:SOUR VID selects video triggering.

4.10.3 Line

Sets the trigger to start a new sweep/measurement to be synchronized with the next cycle of the line voltage.

Key Path: **Trig**

Remote Command:

See [“Trig” on page 287](#)

Example: TRIG:SOUR LINE selects line triggering.

4.10.4 Ext Front

Sets the trigger to start a new sweep/measurement whenever the external voltage (connected to EXT TRIGGER INPUT on the front panel) passes through approximately 1.5 volts. The external trigger signal must be a 0 V to +5 V TTL-type signal.

Key Path: Trig

SCPI Status Bits/

OPC Dependencies: Line trigger is not available when operating from a dc power source.

Remote Command:

See [“Trig” on page 287](#)

Example: TRIG:SOUR EXT to select front panel external triggering.

4.10.5 Ext Rear

Sets the trigger to start a new sweep/measurement whenever the external voltage (connected to TRIGGER IN on the rear panel) passes through approximately 1.5 volts. The external trigger signal must be a 0 V to +5 V TTL-type signal.

Key Path: Trig

Remote Command:

See [“Trig” on page 287](#)

Example: TRIG:SOUR EXT2 selects rear panel external triggering.

4.10.6 RF Burst (Wideband)

Allows the analyzer to be triggered by an RF burst envelope signal.

Key Path: Trig

Remote Command:

See [“Trig” on page 287](#)

Example: TRIG:SOUR RFB

4.10.7 Trig Slope

Controls the trigger polarity. It is positive to trigger on a rising edge and negative to trigger on a falling edge.

Key Path: **Trig**

Dependencies/

Couplings: Not available for Free Run.

State Saved: Saved in instrument state.

Factory Preset: Positive (rising edge)

Remote Command:

```
:TRIGger[:SEQuence]:SLOPe POSitive|NEGative
```

```
:TRIGger[:SEQuence]:SLOPe?
```

Example: TRIG:SLOP NEG

4.10.8 Trig Delay

Allows you to control a time delay during which the analyzer will wait to begin a sweep after receiving an external or line trigger signal. You can use negative delay to pre-trigger the instrument.

NOTE Trigger Delay is not available in Free Run, so turning Free Run on turns off Trigger Delay, but preserves the value of Trigger Delay.

Key Path: **Trig**

Dependencies/

Couplings: This function is not available when Trigger is Free Run or Video.

This function is not available when Gate is on.

State Saved: Saved in instrument state.

Factory Preset: Off, 1 μ s

Range: -150 ms to +500 ms

History: Added with firmware revision A.02.00

Remote Command:

```
:TRIGger[:SEQuence]:DELay <time>
```

```
:TRIGger[:SEQuence]:DELay?
```

```
:TRIGger[:SEQuence]:DELay:STATE OFF|ON|0|1
```

```
:TRIGger[:SEQuence]:DELay:STATE?
```

Example: TRIG:DEL:STAT ON
TRIG:DEL 100 ms

4.10.9 Trig Offset (Remote Command Only)

This command sets the trigger offset. Trigger offset refers to the specified time interval before or after the trigger event from which data is to be written to the trace, and then displayed. Ordinarily, the trigger offset value is zero, and trace data is displayed beginning at the trigger event. A negative trigger offset value results in the display of trace data prior to the trigger event. A positive trigger offset value results in an effective delay in the display of trace data after the trigger event.

The trigger offset value used when the feature is enabled will depend on the following parameters:

- Nominal trigger offset value originally entered
- Specific instrument hardware in use
- Sweep time
- Number of sweep points

The effective trigger offset value will be re-calculated whenever any of these parameters change.

State Saved: Saved in instrument state.

Factory Preset: 0 s

Range: Hardware specific; dependent upon the ADC being used, current state and the number of sweep points.

History: Added with firmware revision A.02.00

Remote Command:

```
:TRIGger[:SEQuence]:OFFSet <time>
```

```
:TRIGger[:SEQuence]:OFFSet?
```

```
:TRIGger[:SEQuence]:OFFSet:STATe OFF|ON|0|1
```

```
:TRIGger[:SEQuence]:OFFSet:STATe?
```

Remote Command Notes: Trigger offset can only be turned on when in zero span and the resolution bandwidth is 1 kHz or greater (non-digital bandwidths). Trigger offset is available for all trigger modes.

Example: TRIG:OFFS 100 ms
TRIG:OFFS:STAT ON turns on the trigger offset.

5 One-Button Measurement Functions

This chapter provides you with functional descriptions, and remote programming commands for all measurements available to you when you press the front-panel **Measure** key (Spectrum Analysis mode is selected).

One - Button Measurement Functions

This section provides key descriptions and programming information for each key associated with the measurements available when you press the front-panel **Measure** key. Note that the information for keys common to all measurements (**Measure**, **Meas Control**, **Mode Setup**, **Restart**, and **Single**) is presented first and the information unique to each measurement is grouped by measurement type. Use the table below to locate the key descriptions and remote commands for the measurement of interest.

Table 5-1

Key Function	Page Location
Measure	297
Meas Control	329
Mode Setup	333
Restart	347
Single	349
ACP Measurement	
Meas Setup	351
Trace/View	367
Burst Power Measurement	
Meas Setup	371
Trace/View	377
CCDF Measurement (Power Stat)	
Meas Setup	381
Display	385
Span X Scale	389
Marker	391
Channel Power Measurement	
Meas Setup	399
Trace/View	405
Harmonic Distortion Measurement	
Meas Setup	409
Trace/View	421

Table 5-1

Key Function	Page Location
Intermod (TOI) Measurement	
Meas Setup	423
Mult-Carrier Power Measurement	
Meas Setup	429
Trace/View	447
Occupied BW Measurement	
Meas Setup	451
Spectrum Emission Mask Measurement	
Meas Setup	457
Trace/View	477
Display	479
Span X Scale	481
Marker	483
Spurious Emissions Measurement	
Meas Setup	485

5.1 MEASURE (Spectrum Analysis Mode)

In the Spectrum Analysis mode (see the **Mode** key), this key displays a menu that lets you to make transmitter power measurements such as adjacent channel power, occupied bandwidth, and harmonic distortion measurements. If other modes are available and have been selected, the measurements for that particular mode will be displayed. Some common settings can be made for these measurements using the function under the **Mode Setup** key. For example, you may select one of several radio standards available by pressing **Mode Setup, Radio Std.**

NOTE The measurements described in the “One-Button Measurement Functions” chapter are available in SA mode (see **Mode** key). Other measurements are available in other modes if an optional personality is installed.

Dependencies/

Couplings: When a measurement is activated, Signal Track, Video Averaging, Segmented Sweep, Band Power and Marker Noise will be turned off.

Remote Command Info:

5.1.1 Command Interactions: MEASure, CONFigure, FETCh, INITiate and READ

Figure 1 Measurement Group of Commands

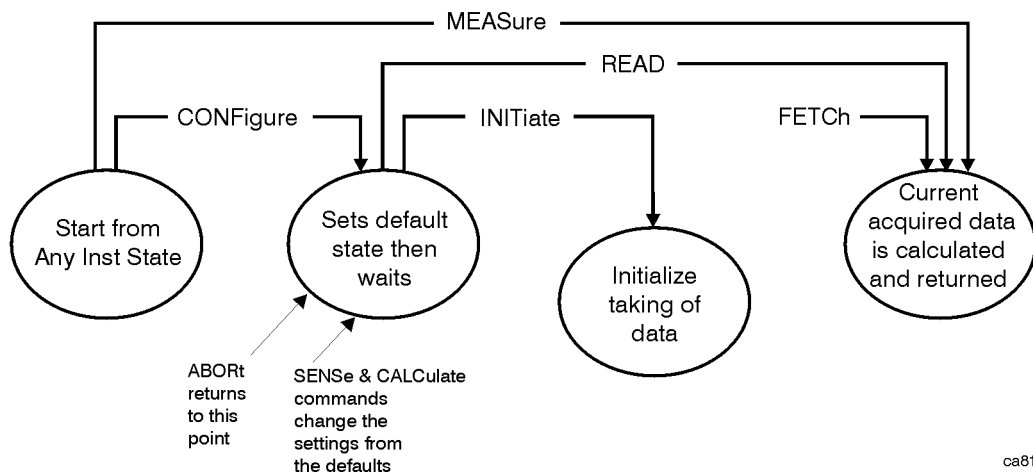

Measure Commands:

:MEASure:<measurement> [n] ?

This is a fast single-command way to make a measurement using the factory default instrument settings. These are the settings and units that conform to the Mode Setup settings (e.g. radio standard) that you have currently selected.

- Stops the current measurement (if any) and sets up the instrument for the specified measurement using the factory defaults
- Initiates the data acquisition for the measurement
- Blocks other SCPI communication, waiting until the measurement is complete before returning results.
- After the data is valid it returns the scalar results, or the trace data, for the specified measurement. The type of data returned may be defined by an [n] value that is sent with the command.

The scalar measurement results will be returned if the optional [n] value is not included, or is set to 1. If the [n] value is set to a value other than 1, the selected trace data results will be returned. See each command for details of what types of scalar results or trace data results are available.

ASCII is the default format for the data output. (Older versions of Spectrum Analysis and Phase Noise mode measurements only use ASCII.) The binary data formats should be used for handling large blocks of data since they are smaller and faster than the ASCII format. Refer to the FORMat:DATA command for more information.

If you need to change some of the measurement parameters from the factory default settings you can set up the measurement with the CONFigure command. Use the commands in the SENSE:<measurement> and CALCulate:<measurement> subsystems to change the settings. Then you can use the READ? command to initiate the measurement and query the results. See [Figure 1](#).

If you need to repeatedly make a given measurement with settings other than the factory defaults, you can use the commands in the SENSE:<measurement> and CALCulate:<measurement> subsystems to set up the measurement. Then use the READ? command to initiate the measurement and query results.

Measurement settings persist if you initiate a different measurement and then return to a previous one. Use READ:<measurement>? if you want to use those persistent settings. If you want to go back to the default settings, use MEASure:<measurement>?.

Configure Commands:

:CONFigure:<measurement>

This command stops the current measurement (if any) and sets up the instrument for the specified measurement using the factory default instrument settings. It sets the instrument to single measurement mode but should not initiate the taking of measurement data unless INIT:CONTinuous is ON. After you change any measurement settings, the READ command can be used to initiate a measurement without changing the settings back to their defaults.

The CONFigure? query returns the current measurement name.

Fetch Commands:

:FETCh:<measurement>[n]?

This command puts selected data from the most recent measurement into the output buffer. Use FETCh if you have already made a good measurement and you want to return several types of data (different [n] values, e.g. both scalars and trace data) from a single measurement. FETCh saves you the time of re-making the measurement. You can only FETCh results from the measurement that is currently active, it will not change to a different measurement.

If you need to get new measurement data, use the READ command, which is equivalent to an INITiate followed by a FETCh.

The scalar measurement results will be returned if the optional [n] value is not included, or is set to 1. If the [n] value is set to a value other than 1, the selected trace data results will be returned. See each command for details of what types of scalar results or trace data results are available. The binary data formats should be used for handling large blocks of data since they are smaller and transfer faster than the ASCII format. (FORMat:DATA)

FETCh may be used to return results other than those specified with the original READ or MEASure command that you sent.

INITiate Commands:

:INITiate:<measurement>

This command is not available for measurements in all the instrument modes:

- Initiates a trigger cycle for the specified measurement, but does not output any data. You must then use the FETCh<meas> command to return data. If a measurement other than the current one is specified, the instrument will switch to that measurement and then initiate it.
For example, suppose you have previously initiated the ACP measurement, but now you are running the channel power measurement. If you send INIT:ACP? it will change from channel power to ACP and will initiate an ACP measurement.
- Does not change any of the measurement settings. For example, if you have previously started the ACP measurement and you send INIT:ACP? it will initiate a new ACP measurement using the same instrument settings as the last time ACP was run.
- If your selected measurement is currently active (in the idle state) it triggers the measurement, assuming the trigger conditions are met. Then it completes one trigger cycle. Depending upon the measurement and the number of averages, there may be multiple data acquisitions, with multiple trigger events, for one full trigger cycle. It also holds off additional commands on GPIB until the acquisition is complete.

READ Commands:

:READ:<measurement>[n]?

- Does not preset the measurement to the factory default settings. For example, if you have previously initiated the ACP measurement and you send READ:ACP? it will initiate a new measurement using the same instrument settings.
- Initiates the measurement and puts valid data into the output buffer. If a measurement other than the current one is specified, the instrument will switch to that measurement before it initiates the measurement and returns results.

For example, suppose you have previously initiated the ACP measurement, but now you are running the channel power measurement. Then you send READ:ACP? It will change from channel power back to ACP and, using the previous ACP settings, will initiate the measurement and return results.

- Blocks other SCPI communication, waiting until the measurement is complete before returning the results

If the optional [n] value is not included, or is set to 1, the scalar measurement results will be returned. If the [n] value is set to a value other than 1, the selected trace data results will be returned. See each command for details of what types of scalar results or trace data results are available. The binary data formats should be used when handling large blocks of data since they are smaller and faster than the ASCII format. (FORMat:DATA)

5.1.2 Meas Off

Turns the measurement function off, so no measurement is currently active. When **Meas Off** is selected there are no functions under the **Meas Setup** key.

Key Path: MEASURE

Remote Command:

:CONFigure:SANalyzer

Remote Command Notes: :CONFigure:SANalyzer causes the present measurement to exit and places the analyzer in spectrum analysis mode.

Example: CONF:SAN

5.1.3 Channel Power

Channel Power measures the power and power spectral density in the channel bandwidth that you specify. One marker pair on the display indicates the edges of the channel bandwidth. The center frequency, reference level, and channel bandwidth must be set by the user. For more information see “[Meas Setup \(Channel Power—CHP\)](#)” on page 399.

You can configure measurement settings by pressing **Meas Setup** after selecting **Channel Power**. You can make a measurement in single or continuous sweep mode. Pressing **Meas Control** enables you to pause or restart a measurement, or toggle between continuous and single measurement. To set **Ref Level** automatically, use **Optimize Ref Level**.

Figure 2 Channel Power Measurement Results

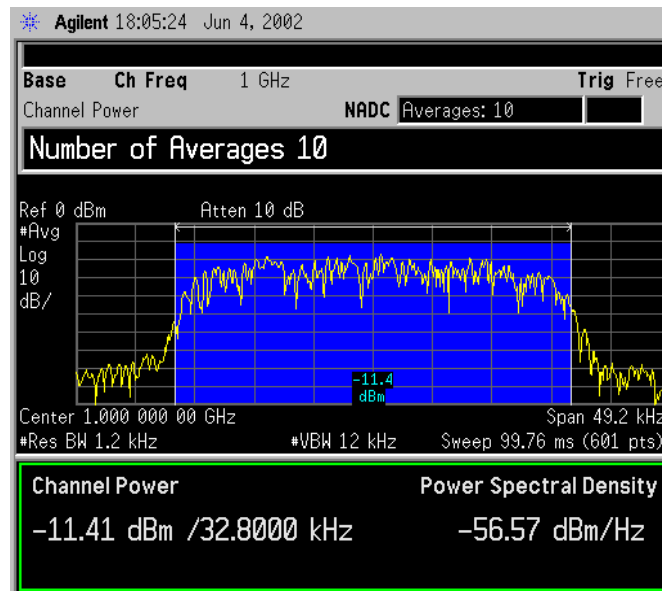

NOTE The displayed trace is the current trace, not the averaged trace.

Pressing **Meas Setup** after **Channel Power** has been selected will access the channel power measurement setup menu. Pressing **Radio Standard** after **Mode Setup** has been selected will access all the Radio Standards available for which this measurement can be applied. Pressing **Meas Control** after **Channel Power** has been selected will access the channel power measurement control menu which allows you to pause or restart your measurement, or toggle between continuous and single measurement.

When a DVB-T radio standard is selected, this measurement will also compare the input signal against a pre-defined spectrum mask. The mask amplitudes defined in the DVB-T specification (ETSI EN 300 744 V1.4.1) range from 0 dB to 100 dB. This is for power measured in a 4kHz bandwidth therefore an adjustment to these values will need to be made as the measurement is made in a 7.61MHz bandwidth.

The measurement makes two sweeps, one in a 4kHz bandwidth and one in a 7.61MHz bandwidth, then computes the difference between the two. This value will be used to adjust the mask settings. As this value is calculated as part of the measurement setup, it is

expected that the DVB-T signal to be measured will be present prior to the standard being selected. The mask will be positioned relative to the power measured in the 7.61MHz bandwidth. The pass/fail indicator will be used to determine if the input signal exceeds the mask or not.

If the current span setting is narrower than the mask width, the mask will not be displayed and the message 10191 displayed. Increase the span to at least the mask width to display the mask. When the mask is not displayed, the pass/fail functionality will not be executed therefore no pass/fail flag will be displayed.

To ensure accuracy this measurement requires a specific minimum Sweep Point to Span ratio. This is calculated using; $\text{Sweep Points} = \text{Span} / (\text{Closest Mask Breakpoint} / 2)$, then rounded off.

For DVB-T measurements using 24 MHz Span, the number of Sweep Points is 2001. If the Sweep Point to Span ratio is changed to a value less than the value obtained using the above algorithm, the message 10192 is then displayed, although the measurement is still made using the new sweep point to span ratio.

Key Path: MEASURE

Remote Command:

Measurement Results Available	
Command	Results Returned
:CONFigure:CHPower :INITiate:CHPower	Not Applicable
:FETCh:CHPower? :MEASure:CHPower? :READ:CHPower?	Returns two values that correspond to the Channel Power and Power Spectral Density.
:FETCh:CHPower:CHPower? :MEASure:CHPower:CHPower? :READ:CHPower:CHPower?	Returns a single value that corresponds to the Channel Power.
:FETCh:CHPower:DENSity? :MEASure:CHPower:DENSity? :READ:CHPower:DENSity?	Returns a single value that corresponds to the Power Spectral Density.

Remote Command Notes: The main channel power is returned in the current amplitude units, and the density value is returned in current amplitude units/Hz

Example: FETC:CHP? or MEAS:CHP? or READ:CHP? command returns scalar results of main channel power and power density.

FETC:CHP:CHP? or MEAS:CHP:DENS? or READ:CHP:DENS? commands will return the single scalar result specified.

5.1.4 Occupied BW

Occupied Bandwidth integrates the power of the displayed spectrum and puts markers at the frequencies between which a selected percentage of the power is contained. The measurement defaults to 99% of the occupied bandwidth power. The power-bandwidth routine first computes the combined power of all signal responses contained in the trace. For 99% occupied power bandwidth, markers are placed at the frequencies on either side of 99% of the power. 1% of the power is evenly distributed outside the markers. The difference between the marker frequencies is the 99% power bandwidth and is the value displayed. For more information see “[Meas Setup \(Occupied Bandwidth—OBW\)](#)” on page 451.

The occupied bandwidth function also indicates the difference between the analyzer center frequency and the center frequency of the channel, referred to as “Transmit Freq Error.” The measurement can be made in single or continuous sweep mode. The center frequency, reference level, and channel spacing must be set by the user.

To configure measurement settings, press **Meas Setup** after selecting **Occupied BW**. Pressing **Radio Standard** after **Mode Setup** has been selected will access all the Radio Standards available for which this measurement can be applied. Pressing **Meas Control** enables you to pause or restart a measurement, or toggle between continuous and single measurement.

Key Path: MEASURE

Remote Command:

Measurement Results Available	
Command	Results Returned
:CONFigure:OBW :INITiate:OBW	Not Applicable
:FETCh:OBW? :MEASure:OBW? :READ:OBW?	Returns two values that correspond to the Occupied BW and Transmit Frequency Error in Hertz.
:FETCh:OBW:OBWidth? :MEASure:OBW:OBWidth? :READ:OBW:OBWidth?	Returns a single value that corresponds to the Occupied BW in Hertz.
:FETCh:OBW:FERRor?:MEASu re:OBW:FERRor? :READ:OBW:FERRor?	Returns a single value that corresponds to the Transmit Frequency Error in Hertz.
:FETCh:OBW:XDB? :MEASure:OBW:XDB? :READ:OBW:XDB?	Returns a single value that corresponds to the x dB BW in Hertz.

Remote Command Notes: The results for both values are returned in Hz.

Example: FETC:OBW? or MEAS:OBW? or READ:OBW? command returns scalar results of occupied bandwidth and transmit frequency error.

FETC:OBW:OBW? or MEAS:OBW:FERR? or READ:OBW:FERR? commands

will return the single scalar result specified.

5.1.5 Adjacent Channel Power—ACP

Adjacent Channel Power (ACP) is a measure of the power that leaks into adjacent transmit channels. Depending on the radio standard selected from the Mode Setup menu, this measurement can run in several different modes in order to measure different types of signals. For more information see “[Meas Setup \(Adjacent Channel Power—ACP\)](#)” on page 351.

Turns on the adjacent channel power measurement. The center frequency, reference level, and channel bandwidth must be set by the user. The span is set according to the frequency and bandwidth of the offsets that are on, and whether the RRC filter is on. The screen is split and the lower window displays the absolute power in the main channel in dBm and the power in each of the adjacent channels in both dBm and dB relative to the main channel power. Also displayed for each offset are offset frequency and reference bandwidth.

The measurement settings may be configured by pressing **Meas Setup** after **ACP** has been selected. Pressing **Radio Standard** after **Mode Setup** has been selected will access all the Radio Standards available for which this measurement can be applied. Pressing **Meas Control** allows you to pause or restart your measurement, or toggle between continuous and single measurement mode.

Key Path: MEASURE

Remote Command:

Measurement Results Available		
Condition	Command	Results Returned
	:CONFigure:ACPower :INITiate:ACPower	Not Applicable
Radio Std = None and only offset A is on	:FETCh:ACPower[n]? :MEASure:ACPower[n]? :READ:ACPower[n]?	Returns 3 comma-separated values that correspond to: main channel power, lower-adjacent channel power (dBc), and upper-adjacent channel power (dBc).
Radio Std ≠ None <i>or</i> Radio Std = None and more than one offset is on Meas Type = Total Pwr Ref		Returns 28 comma-separated values that correspond in the following order: <ol style="list-style-type: none"> 1. Main Channel- relative power (dB) 2. Main Channel- absolute power (dBm) 3. Main Channel- relative power (dB) 4. Main Channel- absolute power (dBm) 5. Negative Offset Frequency (1) - relative power (dB) 6. Negative Offset Frequency (1) - absolute power (dBm) 7. Positive Offset Frequency (1) - relative power (dB) 8. Positive Offset Frequency (1) - absolute power (dBm) ... 25. Negative Offset Frequency (6) - relative power (dB) 26. Negative Offset Frequency (6) - absolute power (dBm) 27. Positive Offset Frequency (6) - relative power (dB) 28. Positive Offset Frequency (6) - absolute power (dBm) Main channel relative power is relative to the main channel absolute power, and therefore is always equal to 0.00 dB.

Measurement Results Available (Continued)		
Condition	Command	Results Returned
Radio Std \neq None <i>or</i> Radio Std = None and more than one offset is on Meas Type = Total Pwr Ref		Returns 28 values that correspond in the following order: 1. Main Channel- relative power spectral density (dB) 2. Main Channel- power spectral density (dBm/Hz) 3. Main Channel- relative power spectral density (dB) 4. Main Channel- power spectral density (dBm/Hz) 5. Negative Offset Frequency (1) - relative power spectral density (dB) 6. Negative Offset Frequency (1) - power spectral density (dBm/Hz) 7. Positive Offset Frequency (1) - relative power spectral density (dB) 8. Positive Offset Frequency (1) - power spectral density (dBm/Hz) ... 25. Negative Offset Frequency (6) - relative power (dB) 26. Negative Offset Frequency (6) - absolute power (dBm) 27. Positive Offset Frequency (6) - relative power (dB) 28. Positive Offset Frequency (6) - absolute power (dBm) Main channel relative power is relative to the main channel power spectral density, and therefore is always equal to 0.00 dB.

Remote Command Notes: The main channel power is returned in the current amplitude units, and the lower and upper channel results are always returned in dB.

Example: FETC:ACP? or MEAS:ACP? or READ:ACP? commands return the scalar results of main channel power, lower channel power (relative), and upper channel power (relative) if only one offset is set to on and the Radio Standard is set to None. Otherwise, 28 values are returned. If **Meas Type** is **Total Power Ref**, these are the main channel power in dBm and in dBc from the carrier (0 dBc) each repeated, followed by the absolute and relative power levels for each lower and upper offset if Meas Type is Total Power Ref. Otherwise they are the main channel power spectral density and relative power spectral density (0 dB) each repeated, followed by the absolute and relative spectral density values for each lower and upper offset.

5.1.6 Multi-Carrier Power

Multi-Carrier Power is the measure of the power that leaks into adjacent transmit channels when two or more carriers are present. The results reported are identical to the adjacent power measurement, but the setup is different to allow for two or more carriers. For more information see [“Meas Setup \(Multi-Carrier Power—MCP\)”](#) on page 429.

The measurement settings may be configured by pressing **Meas Setup** after **Multi-Carrier Power** has been selected. Pressing **Meas Control** allows you to pause or restart your measurement, or toggle between continuous and single measurement mode.

Key Path: MEASURE

Remote Command:

Measurement Results Available		
Command	n	Results Returned
:CONFigure:MCPower	N/A	Not Applicable
:FETCh:MCP[n]? :MEASure:MCP[n]? :READ:MCP[n]?	n=1 (or not specified)	<p>Returns 20 comma-separated scalar results, in the following order.</p> <ol style="list-style-type: none"> 1. First Carrier - relative power (dBc) 2. First Carrier - absolute power (dBm) 3. Second carrier frequency - relative power (dBc) 4. Second carrier frequency - absolute power (dBm) 5. lower offset A - relative power (dBc) 6. lower offset A - absolute power (dBm) 7. upper offset A - relative power (dBc) 8. upper offset A - absolute power (dBm) 9. lower offset B - relative power (dBc) 10. lower offset B - absolute power (dBm) 11. upper offset B - relative power (dBc) 12. upper offset B - absolute power (dBm) 13. lower offset C - relative power (dBc) 14. lower offset C - absolute power (dBm) 15. upper offset C - relative power (dBc) 16. upper offset C - absolute power (dBm) 17. NaN returned 18. NaN returned 19. NaN returned 20. NaN returned <p>If the results are not available, -999.0 is returned.</p>
:FETCh:MCPower? :MEASure:MCPower? :READ:MCPower?	n=2...13	Returns absolute and relative values for carrier n-1. If results are not available -999.0 is returned

Measurement Results Available (Continued)		
Command	n	Results Returned
:FETCh:MCPower? :MEASure:MCPower? :READ:MCPower?	n=14	<p>Returns 36 comma-separated scalar results, in the following order.</p> <p>1 to 24. All carriers absolute and relative values</p> <p>25. lower offset A - relative power (dBc)</p> <p>26. lower offset A - absolute power (dBm)</p> <p>27. upper offset A - relative power (dBc)</p> <p>28. upper offset A - absolute power (dBm)</p> <p>29. lower offset B - relative power (dBc)</p> <p>30. lower offset B - absolute power (dBm)</p> <p>31. upper offset B - relative power (dBc)</p> <p>32. upper offset B - absolute power (dBm)</p> <p>33. lower offset C - relative power (dBc)</p> <p>34. lower offset C - absolute power (dBm)</p> <p>35. upper offset C - relative power (dBc)</p> <p>36. upper offset C - absolute power (dBm)</p> <p>If the results are not available, -999.0 is returned.</p>

Example: FETC:MCP? or MEA:MCP? or READ:MCP?

5.1.7 Power Stat CCDF

The CCDF measurement is a statistical measurement of a high-level signal or peak power. It shows in both graphical and tabular form for what percentage of the time a signal exceeds its average power, and by how much this average is exceeded. For more information see “[Meas Setup \(Complementary Cumulative Distribution Function—CCDF\)](#)” on page 381.

For each single sweep of this measurement, the average power is defined by:

$$P_{avg} = \left(\frac{\sum_1^n (V^2/Z_0)}{n} \right)$$

where V is the envelope voltage, Z₀ is the characteristic impedance, and n is the number of samples (32k maximum).

P_{avg} is used as a guideline to define the probability of the samples, which is xdB above the average power. The number of samples collected per sweep depends upon the sampling rate and the setting of the measurement interval. Multiple sweeps may be required if the sample number exceeds the number of samples collected per sweep. The results and the CCDF curve are updated after each sweep.

Results from a 2.17 GHz 3GPP W-CDMA input signal are shown below in [Figure 3](#).

NOTE It is important to set the correct center frequency before initiating this measurement.

Figure 3 Power Stat CCDF Measurement Results

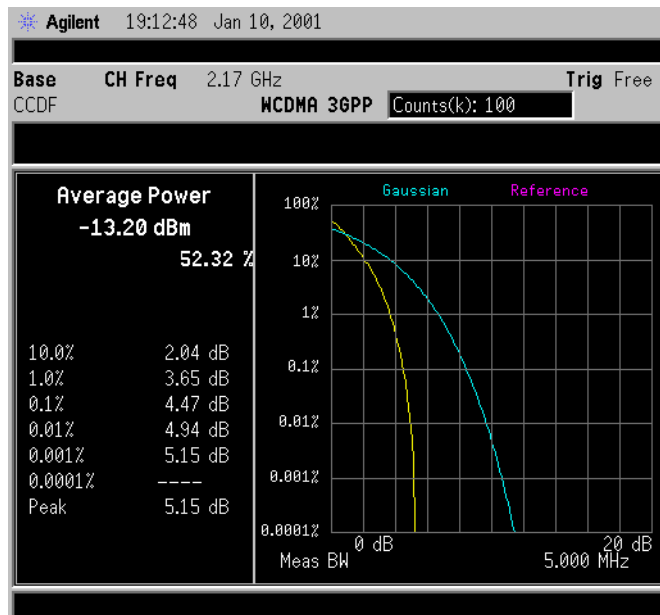

Pressing **Meas Setup** after **Power Stat CCDF** has been selected will access the Power Stat CCDF measurement setup menu. The factory defaults provide a good starting point for this measurement. The settings are adjustable, however, to meet specific requirements. Pressing **Radio Standard** after **Mode Setup** has been selected will access all the Radio Standards available for which this measurement can be applied. Pressing **Meas Control** after **Power Stat CCDF** has been selected will access the Power Stat CCDF measurement control menu which allows you to pause or restart your measurement, or toggle between continuous and single measurement.

Key Path: MEASURE

Remote Command:

Measurement Results Available		
Command	n	Results Returned
:CONFigure:PSTatistic :INITiate:PSTatistic	N/A	Not Applicable
:FETCh:PSTatistic[n]? :MEASure:PSTatistic[n]? :READ:PSTatistic[n]?	n=1 (or not specified)	Returns 10 scalar results, in the following order. <ol style="list-style-type: none"> 1. Average input power (in dBm) 2. Probability at the average input power (in%) 3. Power level that has 10% of the power 4. Power level that has 1% of the power 5. Power level that has 0.1% of the power 6. Power level that has 0.01% of the power 7. Power level that has 0.001% of the power 8. Power level that has 0.0001% of the power 9. Peak power (in dB) 10. Count
	n=2	Returns a series of 501 floating point numbers (in percent) that represent the current measured power statistics trace. This is the probability at specific power levels (average power), in the following order: <ol style="list-style-type: none"> 1. Probability at 0 dB power 2. Probability at 0.1 dB power 3. Probability at 0.2 dB power ... 501. Probability at 50.0 dB power
	n=3	Returns a series of 501 floating point numbers (in percent) that represent the Gaussian trace. This is the probability at specific power levels (average power), in the following order: <ol style="list-style-type: none"> 1. Probability at 0 dB power 2. Probability at 0.1 dB power 3. Probability at 0.2 dB power ... 501. Probability at 50.0 dB power

Measurement Results Available (Continued)		
Command	n	Results Returned
	n=4	<p>Returns a series of 501 floating point numbers (in percent) that represent the user-definable reference trace. This is the probability that at specific power levels (average power) will occur, as follows:</p> <ol style="list-style-type: none"> 1. Probability at 0 dB power 2. Probability at 0.1 dB power 3. Probability at 0.2 dB power ... 501. Probability at 50.0 dB power

Remote Command Notes: To save trace data use the fetch methods shown above.

Example: FETC:PST? or MEAS:PST? or READ:PST?
 FETC:PST2? or MEAS:PST2? or READ:PST2?
 FETC:PST3? or MEAS:PST3? or READ:PST3?

5.1.8 Harmonic Distortion

The range table state determines which harmonics are to be measured. If **Range Table** is set to **Off**, for each harmonic to be measured, the center frequency will be set to the appropriate integer multiple of the fundamental frequency and a sweep taken. The amplitude is calculated by averaging the power in the trace and is displayed in the results table in the results window. The desired Res BW value for each harmonic is calculated by multiplying the harmonic number with the Res BW of the fundamental. This results in the smallest Res BW available being used that is greater than or equal to the computed value. If a Res BW greater than the instrument maximum is calculated then the maximum Res BW of the instrument is used and an asterisk (*) is displayed after the amplitude result of the harmonic to indicate that the desired Res BW was not used. The span for each harmonic is set to zero.

If Range Table is set to On, for each range enabled after the fundamental, the center frequency will be set to the frequency of each range. If the current span is set to zero, the amplitude is calculated by averaging the power in the trace and is displayed in the results table in the results window. If the range has a non-zero span, the amplitude is calculated by making a band-power measurement over the span and is displayed in the results table in the results window.

After the specified number of harmonics have been measured and their amplitudes displayed, the total harmonic distortion is computed and displayed in the left-hand portion of the window (view is set to **Harmonics & THD**). If the measurement is in single mode, the display will remain at the last harmonic setting and the analyzer sweep will be stopped. If

the measurement is in continuous mode, the measurement will continually measure the amplitude of the fundamental and harmonics.

For averaged measurements, you may specify the number of sweeps over which the amplitude of each harmonic is measured. This means that if the **Avg Number** is set to **10**, ten sweeps will be taken and averaged for each harmonic to be measured. The total harmonic distortion would then be calculated from these averaged amplitude readings. Note that averaging applies only to the amplitude of the harmonic, and does not affect the frequency at which the amplitude is measured.

Key Path: MEASURE

Remote Command:

Measurement Results Available		
Command	n	Results Returned
:CONFigure:HARMonics :INITiate:HARMonics	N/A	Not Applicable
:FETCh:HARMonics:AMPLitude:ALL? :MEASure:HARMonics:AMPLitude:ALL? :READ:HARMonics:AMPLitude:ALL?	N/A	Returns the amplitude values of the first ten harmonics. The first value (for the fundamental) is measured in dBm. The remaining harmonics are measured in dBm from the fundamental. If fewer than ten harmonics are measured, zero is returned for any harmonic not measured.
:FETCh:HARMonics:AMPLitude[n]? :MEASure:HARMonics:AMPLitude[n]? :READ:HARMonics:AMPLitude[n]?	n=1 to 10 (n=1 for n not specified)	Returns the amplitude of the specified harmonic number n, where n=1 returns the amplitude of the fundamental in units of dBm. For example, n = 9 returns the amplitude of the ninth harmonic measured in dBc from the fundamental.
:FETCh:HARMonics[:DISTortion]? :MEASure:HARMonics[:DISTortion]? :READ:HARMonics[:DISTortion]?	N/A	Returns the computed total harmonic distortion as a percentage.
:FETCh:HARMonics:FREQuency:ALL? :MEASure:HARMonics:FREQuency:ALL? :READ:HARMonics:FREQuency:ALL?	N/A	Returns the frequency values of the first ten harmonics, in Hz. The first harmonic is the fundamental. If fewer than ten harmonics are measured, zero is returned for any harmonic not measured.

Measurement Results Available		
Command	n	Results Returned
:FETCh:HARMonics:FREQuency[n]? :MEASure:HARMonics:FREQuency[n]? :READ:HARMonics:FREQuency[n]?	n=2 to 10 (n=1 for n not specified)	Returns the frequency of the specified harmonic number N (in Hz).
:FETCh:HARMonics:FUNDamental? :MEASure:HARMonics:FUNDamental? :READ:HARMonics:FUNDamental?	N/A	Returns the frequency of the fundamental, measured in Hz.
:FETCh:HARMonics[n]? :MEASure:HARMonics[n]? :READ:HARMonics[n]?	n=1 to 2 (n=1 for n not specified)	<p>These commands return the power of the spurious emissions at the selected harmonic frequencies of the current channel frequency using the selected resolution bandwidth filter. You can set the number of harmonics to be measured. For each harmonic, the reference level is set 40 dB above the largest amplitude limit with input attenuation held constant. The attenuation is set to limit the carrier (fundamental) power at the spectrum analyzer input mixer to the value determined by Max Mixer Lvl.</p> <p>not specified or n=1 Returns one value that corresponds to the total harmonic distortion (RMS voltage %).</p> <p>n=2 Returns one value that corresponds to the total harmonic distortion (dB).</p>

Example: FETC:HARM:AMPL:ALL?
 MEAS:HARM:AMPL2 returns the amplitude of the second harmonic measured in dBc from the fundamental.
 READ:HARM:FREQ10 returns the frequency of the tenth harmonic in Hz.

5.1.9 Burst Power

The burst power measurement is an accurate method of determining the average power for the specified burst. The analyzer is set into zero-span mode, with a sweep time that captures at least one burst. For more information see “[Meas Setup \(Burst Power\)](#)” on page 371.

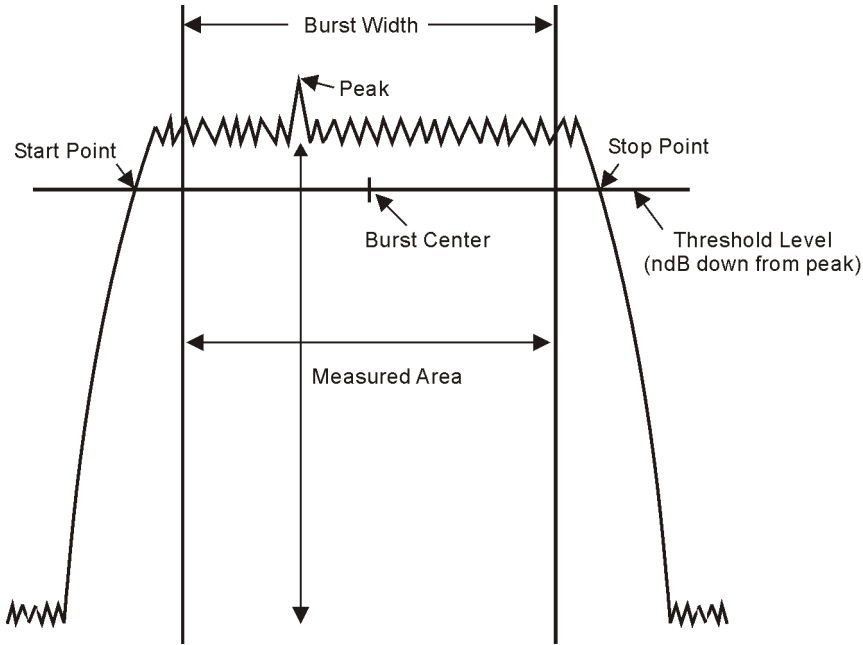

pl746b

The burst power measurement acquires data from the “Measured Area” above when a radio standard is chosen and when **Meas Setup, Meas Method, Measured Burst Width** is selected. When **Meas Setup, Meas Method, Above Threshold Lvl** is selected, the “Measured Area” extends the burst width delimiter lines to the start and stop points.

The mean carrier power is calculated by:

1. converting each trace point amplitude from dBm into linear power
2. Adding the above amplitudes together and dividing by the number of points included in the average.
3. This value is then displayed in logarithmic form (dBm).

$$(P_{avg}) = 10 \log 10 \left\{ \frac{\left(\sum_n^m \left(10^{\frac{p}{10}} \right) \right)}{m - n} \right\}$$

where P_{avg} = average power, n is the start trace point, m = the stop trace point, and p = the trace point amplitude power in dBm.

Figure 4 shows an example of the results obtained when measuring a Bluetooth™ signal and with a user-defined burst width.

Figure 4 Burst Power Measurement Results

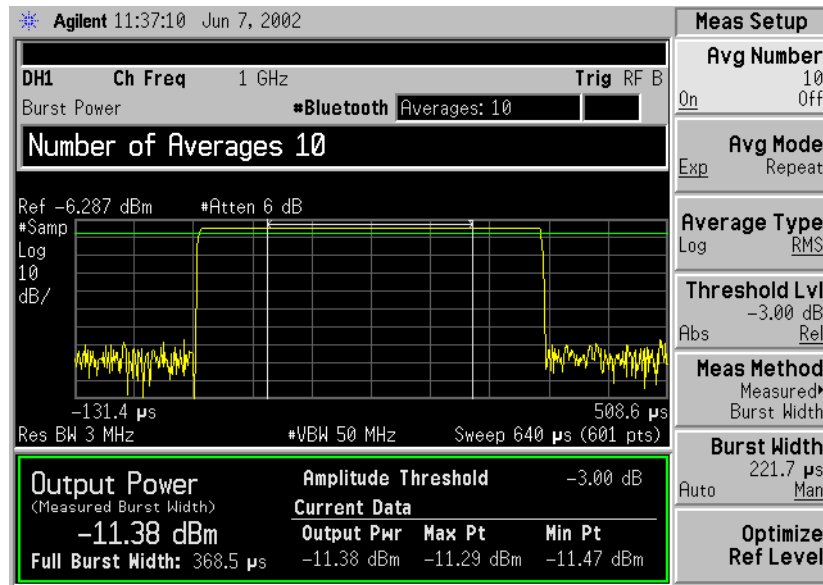

NOTE The analyzer defaults to zero-span mode and the sweep time is set to capture at least one burst. The sweep time can be changed by pressing **Sweep**, **Sweep Time**.

Pressing **Meas Setup** after **Burst Power** has been selected displays the burst power measurement setup menu. Pressing **Meas Control** after **Burst Power** has been selected displays the burst power control menu, where you can pause or restart a measurement, or toggle between continuous and single measurement.

Key Access: **MEASURE**

NOTE The measurements described above are those available in SA mode (see **Mode** key). Other measurements are available in other modes if an optional personality is installed.

Key Path: MEASURE

Remote Command:

Measurement Results Available		
Command	n	Results Returned
:CONFigure:BPOWer :INITiate:BPOWer	N/A	Not Applicable
:FETCh:BPOWer[n]? :MEASure:BPOWer[n]? :READ:BPOWer[n]?	n=1 (or not specified)	Returns 10 scalar results, in the following order. 1. Sample time 2. Power (RMS of carrier power) 3. Power averaged 4. Number of samples, 5. Amplitude threshold (relative) 6. Maximum trace point on the measured part of the burst. 7. Minimum trace point on the measured part of the burst. 8. Burst width (actual measured width, using the threshold level) 9. Measured time 10. Measured points
	n=2	Returns the displayed RF envelope trace data separated by commas. The number of data values is determined by the setting of the trace points parameter.

Example: FETC:BPOW? or MEAS:BPOW? or READ:BPOW?

5.1.10 Intermod (TOI)

The third order intermodulation (TOI) measurement computes and displays the output intercept point (IP3), and places markers upon the trace to indicate the measured signals and third-order products. For more information see “[Meas Setup \(Intermod \(TOI\)\)](#)” on page 423.

Key Path: **MEASURE**

Remote Command:

Measurement Results Available	
Command	Results Returned
:CONFigure:TOIN :INITiate:TOIN	Not Applicable
:FETCh:TOIN? :MEASure:TOIN? :READ:TOIN?	Returns 6 scalar results, in the following order. <ol style="list-style-type: none"> 1. The worst case Output Intercept Power value in dBm. 2. The worst case Output Intermod Point in Hz 3. The lower Output Intercept Power value in dBm 4. The lower Output Intermod Point in Hz 5. The upper Output Intercept Power value in dBm 6. The upper Output Intermod Point in Hz
:FETCh:TOIN:IP2? :MEASure:TOIN:IP2? :READ:TOIN:IP2?	Returns 12 scalar results, in the following order. <ol style="list-style-type: none"> 1. The worst case Output Intermod Point value in Hz. 2. The worst case Output Intermod Power value in dBm. 3. The worst case Output Intercept Power value in dBm 4. The lower base frequency value in Hz 5. The lower base power value in dBm 6. The upper base frequency value in Hz 7. The upper base power value in dBm 8. The lower Output Intermod Point in Hz 9. The lower Output Intermod Power value in dBm 10. The lower Output Intercept Power value in dBm 11. The upper Output Intermod Power value in dBm 12. The upper Output Intermod Point in Hz 13. The upper Output Intercept Power value in dBm
:FETCh:TOIN:IP3? :MEASure:TOIN:IP3? :READ:TOIN:IP3?	Returns the worst case Output Intercept Power value in dBm.

Example: FETC:TOIN? or MEAS:TOIN? or READ:TOIN?

 FETC:TOIN:IP3? or MEAS:TOIN:IP3? or READ:TOIN:IP3?

5.1.11 Spurious Emissions

The spurious emissions measurement identifies and determines the power level of spurious emissions in certain frequency bands. For more information see “[Meas Setup \(Spurious Emissions\)](#)” on page 485.

Key Path: **MEASURE**

Remote Command:

- :CONFigure:SPURious
- :INITiate:SPURious
- :FETCh:SPURious[n]?
- :MEASure:SPURious[n]?
- :READ:SPURious[n]?

n	Results Returned
n=1 (or not specified)	<p>Returns a variable-length list of values containing detailed spur information. The total number of data values returned is (1 + 6x spurs), where x is the number of spurs identified. You can have up to 121 data entries if you have the maximum 20 spurs identified. The values returned are in the following order:</p> <ol style="list-style-type: none"> 1. Number of spurs in items 2 through 6 in this list <p>[Repeat the following for each spur]</p> <ol style="list-style-type: none"> 2. Spur number 3. Range number in which spur was located (integer) 4. Frequency of spur (Hz) 5. Amplitude of spur (dBm) 6. Absolute limit (dBm) 7. Pass or Fail (1 0)
n=2 through 21	Returns trace data values for the selected frequency range (where range number = n – 1). If the selected range is not active, then 9.91E37 is returned for each non-active trace data element.
n=22	Returns the number of spurs found.

Example: **MEAS:SPUR?**

5.1.12 Spectrum Emission Mask

Spectrum Emission Mask measurement includes the in-band and out-of-band spurious emissions. As it applies to W-CDMA (3GPP), this is the power contained in a specified frequency bandwidth at certain offsets relative to the total carrier power. It may also be expressed as a ratio of power spectral densities between the carrier and the specified offset frequency band. For WLAN, the reference power is taken as the peak PSD in the signal,

and all offset results are also the peak PSD in that offset as opposed to the integrated power.

Offsets that are turned off (inactive) will return -999.0 when their results are queried over SCPI.

For more information see “[Meas Setup \(Spectrum Emissions Mask—SEM\)](#)” on page 457.

Key Path: **MEASURE**

Remote Command:

Measurement Results Available		
Command / Condition	n	Results Returned
:CONFigure:SEMask :INITiate:SEMask	N/A	Not Applicable
:FETCh:SEMask[n]? :MEASure:SEMask[n]? :READ:SEMask[n]? Using Total Power Reference	n=1 (or not specified)	Returns 60 scalar results, in the following order: <ol style="list-style-type: none"> 1. Reserved for the future use, returns -999.0 2. Absolute power at the center frequency (reference) area (dBm) 3. Reserved for the future use, returns -999.0 4. Reserved for the future use, returns -999.0 5. Peak frequency in the center frequency (reference) area (Hz) 6. Reserved for the future use, returns -999.0 7. Reserved for the future use, returns -999.0 8. Reserved for the future use, returns -999.0 9. Reserved for the future use, returns -999.0 10. Reserved for the future use, returns -999.0. 11. Relative power on the negative offset A (dBc) 12. Absolute power on the negative offset A (dBm) 13. Relative peak power on the negative offset A (dBc) 14. Absolute peak power on the negative offset A (dBm) 15. Peak frequency in the negative offset A (Hz) 16. Relative power on the positive offset A (dBc) 17. Absolute power on the positive offset A (dBm) 18. Relative peak power on the positive offset A (dBc) 19. Absolute peak power on the positive offset A (dBm) 20. Peak frequency in the positive offset A (Hz) 21. Relative power on the negative offset B (dBc) ... 59. Absolute peak power on the positive offset E (dBm) 60. Peak frequency in the positive offset E (Hz)

Measurement Results Available (Continued)		
Command / Condition	n	Results Returned
Using Power Spectral Density Reference	(Continued) n=1 (or not specified)	Returns 60 scalar results, in the following order: <ol style="list-style-type: none"> 1. Reserved for the future use, returns -999.0 2. Absolute power at the center frequency (reference) area (dBm) 3. Reserved for the future use, returns -999.0 4. Reserved for the future use, returns -999.0 5. Peak frequency in the center frequency (reference) area (Hz) 6. Reserved for the future use, returns -999.0 7. Reserved for the future use, returns -999.0 8. Reserved for the future use, returns -999.0 9. Reserved for the future use, returns -999.0 10. Reserved for the future use, returns -999.0. 11. Relative power on the negative offset A (dB) 12. Absolute power on the negative offset A (dBm/Hz) 13. Relative peak power on the negative offset A (dB) 14. Absolute peak power on the negative offset A (dBm/Hz) 15. Peak frequency in the negative offset A (Hz) 16. Relative power on the positive offset A (dB) 17. Absolute power on the positive offset A (dBm/Hz) 18. Relative peak power on the positive offset A (dB) 19. Absolute peak power on the positive offset A (dBm/Hz) 20. Peak frequency in the positive offset A (Hz) 21. Relative power on the negative offset B (dB) ... 59. Absolute peak power on the positive offset E (dBm/Hz) 60. Peak frequency in the positive offset E (Hz)
	n=2	Returns the displayed frequency domain spectrum trace data separated by comma. The number of data points is determined by the setting of the trace points parameter.
	n=3	Returns the displayed frequency domain absolute limit trace data separated by comma. The number of data points is determined by the setting of the trace points parameter.
	n=4	Returns the displayed frequency domain relative limit trace data separated by comma. The number of data points is determined by the setting of the trace points parameter.

Measurement Results Available (Continued)		
Command / Condition	n	Results Returned
Using Total Power Reference	n=5	<p>Total Power Reference</p> <p>Returns 12 scalar values (in dBm) of the absolute power of the segment frequencies:</p> <ol style="list-style-type: none"> 1. Total power reference (dBm) 2. Reserved for the future use, returns -999.0 3. Negative offset frequency (A) 4. Positive offset frequency (A) ... 11. Negative offset frequency (E) 12. Positive offset frequency (E).
Using Power Spectral Density Reference	n=5	<p>Power Spectral Density Reference</p> <p>Returns 12 scalar values (in dBm/Hz) of the absolute power of the segment frequencies:</p> <ol style="list-style-type: none"> 1. Total power reference (dBm/Hz) 2. Reserved for the future use, returns -999.0 3. Negative offset frequency (A) 4. Positive offset frequency (A) ... 11. Negative offset frequency (E) 12. Positive offset frequency (E).
Using Total Power Reference	n=6	<p>Total Power Reference</p> <p>Returns 12 scalar values (in dBc) of the power relative to the carrier at the segment frequencies:</p> <ol style="list-style-type: none"> 1. Reserved for the future use, returns -999.0 2. Reserved for the future use, returns -999.0 3. Negative offset frequency (A) 4. Positive offset frequency (A) ... 11. Negative offset frequency (E) 12. Positive offset frequency (E).
Using Power Spectral Density Reference	n=6	<p>Power Spectral Density Reference</p> <p>Returns 12 scalar values (in dBc/Hz) of the power relative to the carrier at the segment frequencies:</p> <ol style="list-style-type: none"> 1. Reserved for the future use, returns -999.0 2. Reserved for the future use, returns -999.0 3. Negative offset frequency (A) 4. Positive offset frequency (A) ... 11. Negative offset frequency (E) 12. Positive offset frequency (E).

Measurement Results Available (Continued)		
Command / Condition	n	Results Returned
	n=7	Returns 12 pass/fail test results (0 = passed, or 1 = failed) determined by testing the absolute power in each offset against the specified offset's absolute power limits: 1. Reserved for the future use, returns -999.0 2. Reserved for the future use, returns -999.0 3. Negative offset frequency (A) 4. Positive offset frequency (A) ... 11. Negative offset frequency (E) 12. Positive offset frequency (E).
	n=8	Returns 12 scalar values of the pass/fail (0 = passed, or 1 = failed) results determined by testing the relative power in each offset against the specified offset's relative power limits: 1. Reserved for the future use, returns -999.0 2. Reserved for the future use, returns -999.0 3. Negative offset frequency (A) 4. Positive offset frequency (A) ... 11. Negative offset frequency (E) 12. Positive offset frequency (E).
	n=9	Returns 12 scalar values of frequency (in Hz) that have peak power in each offset: 1. Reserved for the future use, returns -999.0 2. Reserved for the future use, returns -999.0 3. Negative offset frequency (A) 4. Positive offset frequency (A) ... 11. Negative offset frequency (E) 12. Positive offset frequency (E).
	n=10	Returns 12 scalar values (in dBm) of the absolute peak power of the segment frequencies: 1. Reserved for the future use, returns -999.0 2. Reserved for the future use, returns -999.0 3. Negative offset frequency (A) 4. Positive offset frequency (A) ... 11. Negative offset frequency (E) 12. Positive offset frequency (E).

Measurement Results Available (Continued)		
Command / Condition	n	Results Returned
	n=11	Returns 12 scalar values (in dBc) of the peak power relative to the carrier at the segment frequencies: <ol style="list-style-type: none"> 1. Reserved for the future use, returns -999.0 2. Reserved for the future use, returns -999.0 3. Negative offset frequency (A) 4. Positive offset frequency (A) ... 11. Negative offset frequency (E) 12. Positive offset frequency (E).
	n=12	Returns the band power result when in WLAN standard. If not in WLAN standard the value returned will be .999.0

Example: FETC:SEM? or MEA:SEM? or READ:SEM?

5.1.13 Current Measurement Query (Remote Command Only)

This command returns the name of the measurement that is currently running.

Remote Command:

:CONFigure?

Example: CONF?

5.2 Meas Control

These functions allow you to pause and resume the currently selected measurement and to select between continuous or single measurements.

NOTE If no measurement has been selected from the **MEASURE** menu, these functions are not available.

Key Path: Front-panel key

5.2.1 Restart

This function restarts a previously paused measurement at the beginning. If the current measurement is still in process, it will stop it as soon as possible and restart it from the beginning.

Key Path: Front-panel key. It can also be found under Meas Control.

Remote Command:

:INITiate:REStart

Remote Command Notes: This command is equivalent to sending an :ABORt command followed by an :INITiate[:IMMediate] command. See [“Abort the Sweep or Measurement \(Remote Command Only\)” on page 331](#). for more information.

Example: INIT:REST

5.2.2 Measure

Switches the analyzer between triggering the current measurement/sweep continuously or triggering a single measurement. The front panel **Single** key also puts the analyzer in single-measurement mode.

Key Path: **Meas Control**

State Saved: Save

Factory Preset: Continuous

Remote Command:

Use `:INITiate:CONTinuous OFF|ON` See “SWEEP” on page 241.

Remote Command Notes: This command affects sweeping when in the SA mode. It affects measurements when a measurement has been selected from the MEASure command subsystem.

- When ON, at the completion of each trigger cycle, the trigger system immediately initiates another trigger cycle.
- When OFF, the trigger system remains in an “idle” state until CONTinuous is set to ON or an `:INITiate[:IMMediate]` command is received. On receiving the `:INITiate[:IMMediate]` command, it will go through a single trigger cycle, and then return to the “idle” state.
- The query `INIT:CONT?` returns 1 or 0. 1 is returned when the instrument is continuous triggering. 0 is returned when it is single triggering.

Example: `INIT:CONT OFF`

5.2.3 Pause or Resume

This function pauses the currently running measurement. Pressing **Pause** will toggle between pausing and resuming your measurement. The key label will toggle between **Pause** and **Resume**. If an averaged measurement was in progress, the average counter is frozen when the measurement is halted

Key Path: Meas Control

Remote Command:

`:INITiate:PAUSE` to pause the measurement

`:INITiate:RESume` to resume the measurement.

Example: `INIT:PAUS`

Remote Command Notes: See “Abort the Sweep or Measurement (Remote Command Only)” on page 331. for more information.

5.2.4 Trigger a Sweep or Measurement (Remote Command Only)

This command initiates a sweep if in SA mode with no measurement currently selected.

The command is ignored if the instrument is in a measurement (selected under the MEASURE key), but the measurement is currently running, (`INITiate:CONTinuous ON`).

If a measurement is selected but it is in the idle state (i.e. it’s not running, `INITiate:CONT OFF`), this command triggers the instrument, when trigger conditions are met. The trigger system is initiated, it completes one full trigger cycle and returns to the “waiting” state. Depending on the measurement selected and the number of averages, there may be

multiple data acquisitions, with multiple trigger events, for one full trigger cycle. The instrument must have external triggering selected, or the command will be ignored. Use the TRIGger[:SEQuence]:SOURce EXT command to select the external trigger.

History: Added in revision A.02.00

Remote Command:

:INITiate[:IMMediate]

Remote Command Notes: See also the *TRG command and the TRIGger subsystem.

Use the [:SENSE]:<meas>:TRIGger:SOURce command to select the desired trigger. The instrument must be in the single measurement mode. If :INITiate:CONTinuous is ON then the command is ignored.

Use :FETCh? to transfer a measurement result from memory to the output buffer. Refer to individual commands in the MEASure subsystem for more information.

Example: INIT:IMM

5.2.5 Abort the Sweep or Measurement (Remote Command Only)

Stops any sweep or measurement in progress and resets the sweep or trigger system. A measurement refers to any of the measurements found in the MEASURE menu. If the trigger conditions are met, another sweep is initiated immediately.

If :INITiate:CONTinuous is off (single measure), then :INITiate:IMMediate will start a new single measurement.

If :INITiate:CONTinuous is on (continuous measure), a new continuous measurement begins immediately.

The INITiate and/or TRIGger subsystems contain additional related commands.

History: Added in revision A.02.00

Remote Command:

:ABORT

Remote Command Notes: In the continuous measurement mode, the Restart key is equivalent to ABORT.

Example: ABOR

5.3 Mode Setup (Spectrum Analysis Mode)

Enables you to change measurement settings common to *all* measurements in the **MEASURE** menu. In Spectrum Analysis mode, there are several built-in power measurements. Parameters that you set in the Mode Setup menu affect all of these measurements.

Key Path: Front-panel key

5.3.1 Radio Std

Accesses the radio standards key menu to enable you to select a radio standard. Selecting a radio standard modifies spectrum analyzer settings for the measurement activated under the **MEASURE** menu.

NOTE Measurements that are not relevant to the selected radio standard are not supported, and the message Measurement does not support the current radio standard. will be displayed when such a combination is encountered.

Key Path: **Mode Setup**

Factory Preset: None

History: Updated with PSA firmware revision A.04.00

Added with PSA firmware revision A.02.00

Remote Command:

```
[ :SENSe] :RADIo:STANdard[:SELEct]
NONE | IS95a | JSTD | IS95C | GSM | W3GPP | C2000MC1 | C2000DS | C2000MC3 | NADC | PDC | BLUEToo
th | TETRA | WL802DOT11A | WL802DOT11B | WL802DOT11G | HIPERLAN2 | | DVBTGPN | DVBTIPN

[:SENSe] :RADIo:STANdard[:SELEct] ?
```

5.3.1.1 None

Selects no radio standard. If **Radio Std, None** is selected when a measurement is running, all measurement parameters are returned to their default values. Analyzer parameters outside the **MEASURE** or **Meas Setup** key menus are not affected.

Key Type: 1 of N menu

Key Path: **Mode Setup, Radio Std**

History: Added with PSA firmware revision A.02.00

Remote Command:

Use [:SENSe]:RADio:STANdard[:SELEct] See “Radio Std” on page 333.

Example: RAD:STAN NONE

5.3.1.2 IS-95A

Sets the specific parameters for the selected measurement (located under the “MEASURE (Spectrum Analysis Mode)” key description) appropriate for industry standard IS-95A. The Spectrum Emissions Mask, Harmonic Distortion, and Spurious Emissions measurements are not available when this radio standard is selected.

Key Type: 1 of N menu

Key Path: **Mode Setup, Radio Std**

History: Added with PSA firmware revision A.02.00

Remote Command:

Use [:SENSe]:RADio:STANdard[:SELEct] See “Radio Std” on page 333.

Example: RAD:STAN IS95

5.3.1.3 J-STD-008

Sets the specific parameters for the selected measurement (located under the “MEASURE (Spectrum Analysis Mode)” key description) appropriate for industry standard J-STD-008. The Spectrum Emissions Mask, Harmonic Distortion, MCP, and Spurious Emissions measurements are not available when this radio standard is selected.

Key Type: 1 of N menu

Key Path: **Mode Setup, Radio Std**

History: Added with PSA firmware revision A.02.00

Remote Command:

Use [:SENSe]:RADio:STANdard[:SELEct] See “Radio Std” on page 333.

Example: RAD:STAN JSTD

5.3.1.4 IS-95C

Sets the specific parameters for the selected measurement (located under the “MEASURE (Spectrum Analysis Mode)” key description) appropriate for industry standard IS-95C. The Spectrum Emissions Mask, Harmonic Distortion, and Spurious Emissions measurements are not available when this radio standard is selected.

Key Type: 1 of N menu

Key Path: **Mode Setup, Radio Std**
History: Modified with PSA firmware revision A.04.00
Added with PSA firmware revision A.03.00

Remote Command:

Use [:SENSe]:RADio:STANdard[:SElect] See “Radio Std” on page 333.

Example: RAD:STAN IS95C

5.3.1.5 GSM/EDGE

Sets the specific parameters for the selected measurement (located under the “[MEASURE \(Spectrum Analysis Mode\)](#)” key description) appropriate for industry standard GSM/EDGE. Power Stat CCDF and Burst Power are the only measurements available for this standard.

Key Type: 1 of N menu
Key Path: **Mode Setup, Radio Std**
History: Added with PSA firmware revision A.02.00

Remote Command:

Use [:SENSe]:RADio:STANdard[:SElect] See “Radio Std” on page 333.

Example: RAD:STAN GSM

5.3.1.6 3GPP W-CDMA

Sets the specific parameters for the selected measurement (located under the “[MEASURE \(Spectrum Analysis Mode\)](#)” key description) appropriate for industry standard W-CDMA. All measurements except Harmonic Distortion and Spurious Emissions are available for this standard.

Key Type: 1 of N menu
Key Path: **Mode Setup, Radio Std**
History: Added with PSA firmware revision A.02.00

Remote Command:

Use [:SENSe]:RADio:STANdard[:SElect] See “Radio Std” on page 333.

Example: RAD:STAN W3GPP

5.3.1.7 cdma2000 MC-1X

Sets the specific parameters for the selected measurement (located under the “[MEASURE \(Spectrum Analysis Mode\)](#)” key description) appropriate for industry standard cdma2000-MC-1X. All measurements except Harmonic Distortion, Spurious Emissions,

and Spectrum Emission Mask are available for this standard.

Key Type: 1 of N menu

Key Path: **Mode Setup, Radio Std**

History: Modified with PSA firmware revision A.04.00
Added with PSA firmware revision A.02.00

Remote Command:

Use [:SENSE]:RADio:STANdard[:SELEct] See “Radio Std” on page 333.

Example: RAD:STAN C2000MC1

5.3.1.8 cdma2000 MC-3X

Sets the specific parameters for the selected measurement (located under the “[MEASURE \(Spectrum Analysis Mode\)](#)” key description) appropriate for industry standard cdma2000:MC-3X. All measurements except Multi-Carrier Power, Harmonic Distortion, Spurious Emissions and Spectrum Emission Mask are available for this standard.

Key Type: 1 of N menu

Key Path: **Mode Setup, Radio Std**

History: Modified with PSA firmware revision A.04.00
Added with PSA firmware revision A.02.00

Remote Command:

Use [:SENSE]:RADio:STANdard[:SELEct] See “Radio Std” on page 333.

Example: RAD:STAN C2000MC3

5.3.1.9 cdma2000 DS

Sets the specific parameters for the selected measurement (located under the “[MEASURE \(Spectrum Analysis Mode\)](#)” key description) appropriate for industry standard cdma2000:DS. All measurements except Multi-Carrier Power, Harmonic Distortion, Spurious Emissions and Spectrum Emission Mask are available for this standard.

Key Type: 1 of N menu

Key Path: **Mode Setup, Radio Std**

History: Modified with PSA firmware revision A.04.00
Added with PSA firmware revision A.02.00

Remote Command:

Use [:SENSE]:RADio:STANdard[:SELEct] See “Radio Std” on page 333.

Example: RAD:STAN C2000DS

5.3.1.10 NADC

Sets the specific parameters for the selected measurement (located under the “[MEASURE \(Spectrum Analysis Mode\)](#)” key description) appropriate for industry standard NADC. Channel Power and Intermod TOI measurements are not available when **Device (MS)** is selected. All other measurements are available when this radio standard is selected except: Spectrum Emissions Mask, Harmonic Distortion, Spurious Emissions, and Multi-Carrier Power.

Key Type: 1 of N menu

Key Path: **Mode Setup, Radio Std**

History: Modified with PSA firmware revision A.04.00

 Added with PSA firmware revision A.02.00

Remote Command:

Use [:SENSe]:RADio:STANdard[:SElect] [See “Radio Std” on page 333.](#)

Example: RAD:STAN NADC

5.3.1.11 PDC

Sets the specific parameters for the selected measurement (located under the “[MEASURE \(Spectrum Analysis Mode\)](#)” key description) appropriate for industry standard PDC. The Burst Power measurement is not available when **Device (BTS)** is selected. The Channel Power and Intermod TOI measurements are not available when **Device (MS)** is selected. All other measurements except Multi-Carrier Power, Harmonic Distortion, Spurious Emissions and Spectrum Emission Mask measurements are available for this standard.

Key Type: 1 of N menu

Key Path: **Mode Setup, Radio Std**

History: Added with PSA firmware revision A.02.00

Remote Command:

Use [:SENSe]:RADio:STANdard[:SElect] [See “Radio Std” on page 333.](#)

Example: RAD:STAN PDC

5.3.1.12 Bluetooth™

Sets the specific parameters for the selected measurement (located under the “[MEASURE \(Spectrum Analysis Mode\)](#)” key description) appropriate for industry standard Bluetooth™.

Power Stat CCDF and Burst Power are the only measurements available for this standard.

Key Type: 1 of N menu

Key Path: **Mode Setup, Radio Std**

History: Added with PSA firmware revision A.02.00

Remote Command:

Use [:SENSE]:RADio:STANdard[:SElect] See “Radio Std” on page 333.

Example: RAD:STAN BLUE

5.3.1.13 TETRA

Sets the specific parameters for the selected measurement (located under the “[MEASURE \(Spectrum Analysis Mode\)](#)” key description) appropriate for industry standard TETRA. This standard is only available for the Channel Power and ACP measurements.

Key Type: 1 of N menu

Key Path: **Mode Setup, Radio Std**

History: Added with PSA firmware revision A.03.00

Remote Command:

Use [:SENSE]:RADio:STANdard[:SElect] See “Radio Std” on page 333.

Example: RAD:STAN TETR

5.3.1.14 W-LAN

Accesses the W-LAN radio standards key menu to enable you to select a W-LAN standard. Selecting a radio standard modifies spectrum analyzer settings for the CHP or CCDF measurement activated under the **MEASURE** menu.

5.3.1.14.1 802.11a Sets the specific parameters for the selected measurement (located under the “[MEASURE \(Spectrum Analysis Mode\)](#)” key description) appropriate for industry standard 802.11a. This standard is only available for the Spectrum Emission Mask (SEM) measurement.

Key Type: 1 of N menu

Key Path: **Mode Setup, Radio Std**

History: Modified with PSA firmware revision A.04.00

Added with PSA firmware revision A.03.00

Remote Command:

Use [:SENSE]:RADio:STANdard[:SElect] See “Radio Std” on page 333.

Example: RAD:STAN WL802DOT11A

5.3.1.14.2 802.11b Sets the specific parameters for the selected measurement (located under the “[MEASURE \(Spectrum Analysis Mode\)](#)” key description) appropriate for industry standard 802.11b. This standard is only available for the Spectrum Emission Mask (SEM) measurement.

Key Type: 1 of N menu

Key Path: **Mode Setup, Radio Std**

History: Modified with PSA firmware revision A.04.00
Added with PSA firmware revision A.03.00

Remote Command:

Use [:SENSe]:RADio:STANdard[:SElect] [See “Radio Std” on page 333.](#)

Example: RAD:STAN WL802DOT11B

5.3.1.14.3 802.11g Sets the specific parameters for the selected measurement (located under the “[MEASURE \(Spectrum Analysis Mode\)](#)” key description) appropriate for industry standard 802.11g. This standard is only available for the Spectrum Emission Mask (SEM) measurement.

Key Type: 1 of N menu

Key Path: **Mode Setup, Radio Std**

History: Added with PSA firmware revision A.04.00

Remote Command:

Use [:SENSe]:RADio:STANdard[:SElect] [See “Radio Std” on page 333.](#)

Example: RAD:STAN WL802DOT11G

5.3.1.14.4 Hiper LAN/2 Sets the specific parameters for the selected measurement (located under the “[MEASURE \(Spectrum Analysis Mode\)](#)” key description) appropriate for industry standard Hiper LAN2. This standard is only available for the Spectrum Emission Mask (SEM) measurement.

Key Type: 1 of N menu

Key Path: **Mode Setup, Radio Std**

History: Added with PSA firmware revision A.03.00

Remote Command:

Use [:SENSe]:RADio:STANdard[:SElect] [See “Radio Std” on page 333.](#)

Example: RAD:STAN HIPERLAN2

5.3.1.15 DVB-T

Accesses the DVB-T key menu to enable you to select a DVB-T mask filtering standard. Selecting a DVB-T filtering standard modifies spectrum analyzer settings for the CHP or CCDF measurement activated under the **MEASURE** menu.

5.3.1.15.1 L/SECAM/NICAM

Pressing **L/SECAM/NICAM** selects the filtering masks for the L/SECAM/NICAM analog television system.

Key Path: **Mode Setup, DVB-T**

History: Added with PSA firmware revision A.04.00

5.3.1.15.2 G/PAL/NICAM

Pressing **G/PAL/NICAM** selects the filtering masks for the G/PAL/NICAM analog television system.

Key Path: **Mode Setup, DVB-T**

History: Added with PSA firmware revision A.04.00

5.3.1.15.3 I/PAL/NICAM

Pressing **I/PAL/NICAM** selects the filtering masks for the I/PAL/NICAM analog television system.

Key Path: **Mode Setup, DVB-T**

History: Added with PSA firmware revision A.04.00

5.3.2 Radio Std Setup

Accesses the key menu for selecting the device, packet type, or signal bandwidth to be measured.

Key Path: **Mode Setup**

History: Added with PSA firmware revision A.02.00

Remote Command:

There is no equivalent remote command.

5.3.2.1 Signal BW

Allows you to set the measurement bandwidth when **Radio Std (None)** is selected. This function is available only when you select None as the standard.

Key Path: **Mode Setup, Std Setup**

Factory Preset: 3.0 MHz

Default Terminator: Hz

Range: The non-zero span range of the analyzer

History: Added with PSA firmware revision A.02.00

Remote Command:

```
[ :SENSe ] :RADio:STANdard:SBWidth <freq>
```

```
[ :SENSe ] :RADio:STANdard:SBWidth?
```

Example: RAD:STAN:SBW 2MHZ

5.3.2.2 Device BTS/MS

This function is only available when you have selected the standard: IS-95, J-STD-008, cdma2000, W-CDMA, NADC, PDC, TETRA, or GSM. It enables you to select either the base transmitter station (BTS) setup defaults or the mobile station (MS) defaults for the standard that you have selected. This key is unavailable when you select Bluetooth™.

Key Path: **Mode Setup, Std Setup**

Factory Preset: BTS

History: Added with PSA firmware revision A.02.00

Remote Command:

```
[ :SENSe ] :RADio:STANdard:DEvIce BTS|MS
```

```
[ :SENSe ] :RADio:STANdard:DEvIce?
```

Example: RAD:STAN:DEV MS

5.3.2.3 Packet Type

This function is only available when the standard you have selected is Bluetooth™. It enables you to set the instrument settings for testing DH1, DH3, or DH5 packet type.

Key Path: **Mode Setup, Std Setup**

Factory Preset: DH1

History: Added with PSA firmware revision A.02.00

Remote Command:

```
[ :SENSE ] :RADio:STANdard:PACKet DH1 | DH3 | DH5
```

```
[ :SENSE ] :RADio:STANdard:PACKet?
```

Example: RAD:STAN:PACK DH1

5.3.2.4 Band Class

This function is only available when you have selected the standard: IS-95C. It enables you to select the band class.

Key Path: **Mode Setup, Std Setup**

Factory Preset: US/K or Cell

History: Added with PSA firmware revision A.02.00

Remote Command:

```
[ :SENSE ] :RADio:STANdard:BAND:CLASs BC0 | BC1
```

```
[ :SENSE ] :RADio:STANdard:BAND:CLASs?
```

Example: RAD:STAN:BAND:CLAS BC1

5.3.3 Retain Params

Enables you to retain the base-instrument parameter settings used by individual measurements that are typically lost when switching between measurements.

When **Retain Params** is set to **Off**, the values of the fully configurable parameters saved and recalled during a measurement change.

When **Retain Params** is set to **On**, the fully configurable parameters will be saved and recalled during a measurement change, along with **Span**, **Ref Level**, **Single/Cont**, **Detector**, **Avg/VBW Type**, **Points**, and if applicable, **Spectrum/Bar/Combined** and **Graticule On/Off**.

NOTE When **Radio Std** or **Radio Std Setup** is changed, **Retain Params** is set to **Off**. Once **Retain Params** has been set to **Off**, parameters will no longer be retained and any settings you may have entered will be lost.

Key Path: **Mode Setup**

Factory Preset: Off

History: Added with PSA firmware revision A.04.00

Remote Command:

```
[ :SENSE ] :RADio:STANdard:RPARams [ :STATe ] ON | Off | 1 | 0
```

```
[ :SENSE ] :RADio:STANdard:RPARams [ :STATe ] ?
```

Example: RAD:STAN:RPAR Off

5.3.4 Enable All Measurements

Allows you to specify whether all measurements and radio standards are enabled (set to **Yes**) or not (Set to **No**).

NOTE **Enable All Measurements** will be disabled (greyed out) if a measurement is entered when **Enable All Measurements** is set to **Yes** and the measurement entered does not support the currently selected Radio Std. “Select a valid radio standard/measurement combination to enable.” will be displayed.

Key Path: **Mode Setup**

Factory Preset: No

History: Added with PSA firmware revision A.04.00

Remote Command:

```
[ :SENSE ] :RADio:STANdard:EAMeas YES | NO
```

```
[ :SENSE ] :RADio:STANdard:EAMeas ?
```

Example: RAD:STAN:EAM YES

5.3.5 Autorange of Power Setting (Remote command only)

This command is the remote version of the **Optimize Ref Level** key. If this function is applicable to the currently selected measurement, this command sets the reference level and attenuator to optimum values based on the signal present at the input.

NOTE There is always a minimum of 6 dB of attenuation set to protect the analyzer input.

History: Added with PSA firmware revision A.02.00

Remote Command:

```
[ :SENSe] :POWer [:RF] :RANGe:AUTO ONCE
```

Example: POW:RANG:AUTO ONCE

5.4 Restart

This function restarts a previously paused measurement at the beginning. If the measurement is active, it will stop it as soon as possible and restart it from the beginning. If no measurement is active and **Sweep (Single)** is selected, a new sweep is initiated.

When in **Average (On)** mode, (**BW/Avg, Average**) the averaging function is restarted (the trace is reset and the average number is reset to zero).

Key Path: Front-panel key. It can also be found under **Meas Control**.

Remote Command:

`:INITiate:REStart`

Remote Command Notes: This command is equivalent to sending an `:ABORt` command followed by an `:INITiate[:IMMediate]` command. See [“Abort the Sweep or Measurement \(Remote Command Only\)” on page 331](#) for more information.

Example: `INIT:REST`

5.5 Single

If the analyzer is in continuous sweep mode and not in a measurement (**Measure, Meas Off**), pressing **Single** changes the sweep control to single sweep, and executes a sweep after the trigger condition is met. If the analyzer is already in single sweep, pressing **Single** executes a new sweep after the trigger condition is met.

Some instrument settings require more than one sweep to complete the measurement (see **BW/Avg, Average**), or if you have selected a measurement from the functions under the **MEASURE** key, this function sets the trigger system to be initiated only once. In this case the trigger condition can be met only once and then all the necessary sweeps will be executed to make the measurement or complete the averaging function.

With Average on (**BW/Avg, Average (On)**), pressing **Single** resets the average trace and starts the average again from a count of zero. Sweeps are averaged until N sweeps are then taken (where N is the average number), and then the sweep is halted.

State Saved: Single sweep setting is saved in instrument state

Factory Preset: Continuous

Remote Command:

```
:INITiate[:IMMEDIATE]
```

```
*TRG
```

Remote Command Notes: Use the `:TRIGger[:SEQUENCE]:SOURCE` command to select the trigger source.

See also the Single/Continuous sweep function in “Sweep” on page 242 and the command `INITiate:CONTinuous ON|OFF`.

See also the `*TRG` command information in the `STATus` section.

Example: `*TRG`

```
TRIG:IMM
```

5.6 Meas Setup (Adjacent Channel Power—ACP)

If the adjacent channel power (ACP) measurement has been selected in the **Measure** menu of the spectrum analysis mode, this key displays the ACP measurement setup menu.

The adjacent channel power measurement measures the power that leaks into adjacent transmit channels. Depending on the radio standard chosen from the Mode Setup menu, this measurement can run in several different modes in order to measure different types of signals.

Key Path: Front-panel key

History: Added with firmware revision A.02.00.

Remote Command:

There is no equivalent remote command.

5.6.1 Avg Number

Pressing **Avg Number** to **On** enables you to specify the number of measurements that will be averaged when calculating the measurement result. The average will be displayed at the end of each sweep. Setting **Avg Number** to **Off** disables the measurement averaging.

Key Path: **Meas Setup**

State Saved: Saved in instrument state.

Factory Preset: 10 / Off

Range: 1 to 1000

History: Added with firmware revision A.02.00.

Remote Command:

```
[ :SENSe] :ACPower:AVERage:COUNT <integer>
```

```
[ :SENSe] :ACPower:AVERage:COUNT?
```

```
[ :SENSe] :ACPower:AVERage [ :STATe] OFF|ON|0|1 turns the averaging on or off.
```

```
[ :SENSe] :ACPower:AVERage [ :STATe] ?
```

Example: ACP:AVER:COUN 10

```
ACP:AVER:COUN?
```

```
ACP:AVER OFF
```

```
ACP:AVER?
```

5.6.2 Avg Mode

Press **Avg Mode** to select the type of termination control used for the averaging function as either **Exp** or **Repeat**. This determines the averaging action after the specified number of measurements (average count) is reached.

- **EXP** (Exponential Averaging mode)—When you set **Avg Mode** to **Exp**, each successive data acquisition after the average count is reached is exponentially weighted and combined with the existing average. Exponential averaging weights new data more than old data, which facilitates tracking of slow-changing signals. The average will be displayed at the end of each sweep.
- **Repeat**—When you set **Avg Mode** to **Repeat**, after reaching the average count, all previous result data is cleared and the average count is set back to 1.

Key Path: **Meas Setup**

State Saved: Saved in instrument state.

Factory Preset: EXPOnential

History: Added with firmware revision A.02.00.

Remote Command:

```
[ :SENSe] :ACPower:AVERAge:TCONrol EXPOnential|REPeat
```

```
[ :SENSe] :ACPower:AVERAge:TCONrol?
```

Example: ACP:AVG:TCON EXP
 ACP:AVG:TCON?

5.6.3 Chan Integ BW

Press **Chan Integ BW** to specify the range of integration used in calculating the power in the main channel.

Key Path: **Meas Setup**

Key Notes: If **RRC Filter** is on, the actual integration bandwidth used is the displayed integration bandwidth multiplied by (1 + **Filter Alpha**).

State Saved: Saved in instrument state.

Factory Preset: 2.0 MHz or as defined by the selected radio standard.

Default Terminator: Hz

Knob Increment: Span/50 if non-zero span.
 RBW/100 if zero span.

Step Key

Increment: RBW if **CF Step** is set to **Auto** with zero span.

Span/10 if **CF Step** is set to **Auto** with non-zero span.

CF Step if **CF Step** is set to **Manual**.

Range: Depends on the adjacent-channel settings and the minimum and maximum analyzer span.

History: Added with firmware revision A.02.00.

Remote Command:

```
[[:SENSE]:ACPower:BANDwidth|BWIDth:INTegration <freq>
```

```
[[:SENSE]:ACPower:BANDwidth|BWIDth:INTegration?
```

Example: ACP:BWID:INT 5E6

ACP:BWID:INT?

5.6.4 Offset/Limits

Accesses menu keys that allow you to configure the offsets for the ACP measurement.

Key Path: **Meas Setup**

5.6.4.1 Offset

Selects the offset the menu keys will affect. Press Offset until the letter of the desired offset is underlined.

Key Path: **Meas Setup, Offset Setup**

State Saved: Saved in instrument state.

Factory Preset: A

History: Added with firmware revision A.02.00.

Remote Command:

There is no remote command for this function.

5.6.4.2 Offset Freq or Edge Freq

Enables you to set the frequency difference from the center of the main channel to the center of the offset for a maximum of 6 offsets (labeled A-F). It also allows you to turn on/off the offsets that you want to measure.

NOTE This key label changes to **Edge Freq** when **IS-95C**, **cdma2000 MC-1X**, **cdma2000 MC-3X**, and **cdma2000 DS** is selected.

Key Path: **Meas Setup, Offset Setup**
State Saved: Saved in instrument state.
Factory Preset: 3 MHz

The following table shows the default array if no radio standard (**None**) is selected.

Default Terminator: Hz

Knob Increment: Span/50 if non-zero span.

RBW/100 if zero span.

Step Key

Increment: RBW if **CF Step** is set to **Auto** with zero span.

Span/10 if **CF Step** is set to **Auto** with non-zero span.

CF Step if **CF Step** is set to **Manual**.

Range: > 0 Hz to 45 MHz

History: Added with firmware revision A.02.00.

Remote Command:

```
[ :SENSE ] :ACPower:OFFSet:LIST[:FREQuency]
<f_offset>,<f_offset>,<f_offset>,<f_offset>,<f_offset>,<f_offset>
```

```
[ :SENSE ] :ACPower:OFFSet:LIST[:FREQuency] ?
```

```
[ :SENSE ] :ACPower:OFFSet:LIST:STATE
OFF|ON|0|1, OFF|ON|0|1, OFF|ON|0|1, OFF|ON|0|1, OFF|ON|0|1, OFF|ON|0|1
```

```
[ :SENSE ] :ACPower:OFFSet:LIST:STATE?
```

Remote Command Notes: This command, along with commands [:SENSE]:ACPower:OFFSet:LIST:BANDwidth | BWIDth[:INTegration] and [:SENSE]:ACPower:OFFSet:LIST:STATE, are used to set the parameters for all of the offsets, up to six. The following table shows the values of these parameters if no radio standard (**None**) is selected.

Offset	State	Frequency	Integ. BW
A	ON	3 MHz	2 MHz
B	OFF	0	2 MHz
C	OFF	0	2 MHz
D	OFF	0	2 MHz
E	OFF	0	2 MHz
F	OFF	0	2 MHz

Example: Sending fewer than six parameters to one of these commands will leave the values of the unspecified offsets unchanged. If you don't send settings for all 6 offsets, it will set all the offsets that you specified, then it will set any remaining offsets to the same setting as the last offset that you sent.

```
ACP:OFFS:LIST 50 Hz,75 Hz,100 Hz,125 Hz,150 Hz,175 Hz
```

```
ACP:OFFS:LIST:STAT ON,ON,ON,OFF,OFF,OFF
```

For example, after the above command is sent, sending the command with only four parameters (ACP:OFFS:LIST:STAT ON,ON,ON,OFF) will result in the fifth and sixth offset remaining the same as the previous setting (OFF).

5.6.4.3 Ref BW

Sets the reference bandwidth (integration bandwidth) for each offset.

Key Path: Meas Setup, Offset Setup

State Saved: Saved in instrument state.

Factory Preset: 2 MHz, if no radio standard (**None**) is selected.

Default Terminator: Hz

Range: 300 Hz to 20 MHz

History: Added with firmware revision A.02.00.

Remote Command:

```
[ :SENSe] :ACPpower:OFFSet:LIST:BANDwidth|BWIDth[:INTegration]  
<bw>, <bw>, <bw>, <bw>, <bw>, <bw>
```

```
[ :SENSe] :ACPpower:OFFSet:LIST:BANDwidth|BWIDth[:INTegration]?
```

Example: ACP:OFFS:LIST:BAND 50,50,50,50,50,50

```
ACP:OFFS:LIST:BAND?
```

5.6.4.4 Pos Offset Limit

Enables you to set the upper limit for the upper segment of the specified offset pair.

Key Path: Meas Setup, Offset Setup

State Saved: Saved in instrument state.

Factory Preset: 0.00 dB

Default Terminator: dB

Range: -200 dB to 200 dB

One-Button Measurement Functions
Meas Setup (Adjacent Channel Power—ACP)

History: Added with firmware revision A.02.00.

Remote Command:

```
:CALCulate:ACPower:OFFSet:LIST:LIMit:POSitive[:UPPer]:DATA
<rel_power>,<rel_power>,<rel_power>,<rel_power>,<rel_power>,<rel_power>
:CALCulate:ACPower:OFFSet:LIST:LIMit:POSitive[:UPPer]:DATA?
```

Example: CALC:ACP:OFFS:LIST:LIM:POS:DATA 10,10,10,10,10,10
 CALC:ACP:OFFS:LIST:LIM:POS:DATA?

5.6.4.5 Neg Offset Limit

Enables you to set the upper limit for the lower segment of the specified offset pair.

Key Path: **Meas Setup, Offset Setup**

State Saved: Saved in instrument state.

Factory Preset: 0.00 dB

Default Terminator: dB

Range: –200 dB to 200 dB

History: Added with firmware revision A.02.00.

Remote Command:

```
:CALCulate:ACPower:OFFSet:LIST:LIMit:NEGative[:UPPer]:DATA
<rel_power>,<rel_power>,<rel_power>,<rel_power>,<rel_power>,<rel_power>
:CALCulate:ACPower:OFFSet:LIST:LIMit:NEGative[:UPPer]:DATA?
```

Example: CALC:ACP:OFFS:LIST:LIM:NEG:DATA –50,–50,–50,–50,–50,–50
 CALC:ACP:OFFS:LIST:LIM:NEG:DATA?

5.6.5 Meas Type

Press **Meas Type** to specify the reference for the measurement, either **Total Pwr Ref** or **PSD Ref**. Relative values can be displayed referenced to either the total power (**Total Pwr Ref**) or the power spectral density (**PSD Ref**) measured in the main channel.

Key Path: **Meas Setup**

State Saved: Saved in instrument state.

Factory Preset: Total Pwr Ref

History: Added with firmware revision A.02.00.

Remote Command:

```
[[:SENSe]:ACPower:TYPE PSDRef|TPRef
```

```
[ :SENSe] :ACPower :TYPE?
```

Example: ACP:TYPE PSDR
 ACP:TYPE?

5.6.6 Optimize Ref Level

Sets the input attenuator to optimize the robustness of the measurement, in which it is free from errors due to input compression. This setting will not necessarily give the optimum dynamic range, nor the optimum accuracy. No single setting can optimize both, and the optimum setting often depends on the signal characteristics.

NOTE There will always be a minimum of 2 dB of attenuation set to protect the analyzer input.

Key Path: **Meas Setup**
State Saved: Not saved.
History: Added with firmware revision A.02.00.

Remote Command:

```
[ :SENSe] :POWER [:RF] :RANGe:AUTO ONCE
```

Example: POW:RANG:AUTO ONCE

5.6.7 Method

Enables you to set the measurement method to either the integration bandwidth method (IBW) or the resolution bandwidth method (RBW). The resolution bandwidth method is most useful for measuring cdmaOne and cdma2000 signals; the integration bandwidth method is preferred for other signals.

Key Path: **Meas Setup**
State Saved: Saved in instrument state.
Factory Preset: IBW
History: Added with firmware revision A.02.00.

Remote Command:

```
[ :SENSe] :ACPower:METhod IBW|RBW
```

```
[ :SENSe] :ACPower:METhod?
```

Example: ACP:METH RBW
 ACP:METH?

5.6.8 Total Pwr Ref

Enables you to set the adjacent channel power reference to automatic or manual. When set to automatic, the carrier power result reflects the measured power value in the carrier. When set to manual, the last measured value is captured and held, or may be entered by the user. Relative values are displayed, referenced to the total power measured in the main channel.

Key Path: **Meas Setup**

State Saved: Saved in instrument state.

Factory Preset: Auto, Measured carrier power value

History: Added with firmware revision A.02.00.

Remote Command:

```
[ :SENSe] :ACPower:CARRier[:POWer]
```

```
[ :SENSe] :ACPower:CARRier:AUTO[:STATe] OFF|ON|0|1
```

```
[ :SENSe] :ACPower:CARRier:AUTO[:STATe]?
```

Example: ACP:CARR:AUTO 0

ACP:CARR:AUTO?

5.6.9 PSD Ref

Enables you to set the power spectral density in the carrier (main channel) that will be used to compute the relative power spectral density values for the offsets. When the PSD Ref state is set to Auto, this will be set to the measured carrier power spectral density.

Factory Preset: 0 dBm

Terminators: dBm

Default Terminator: dBm

Step Key

Increment: 1, 1.5, 2...

Range: -999 dBm to +999 dBm

History: Added with firmware revision A.02.00.

Remote Command:

```
[ :SENSe] :ACPower:CARRier:CPSD <dBm>
```

```
[ :SENSe] :ACPower:CARRier:CPSD?
```

Remote Command Notes: This function is only available when measurement type is set to PSD Ref, use the command [:SENSe]:ACPower:TYPE PSDRef to select the measurement type.

Example: ACP:CARR:CPSD 5

5.6.10 Limit Test

Pressing **Limit Test** turns the testing of the limit line on or off. When **Limit Test** is set to **On**, each offset is compared to its upper and lower offset limit. In those cases where the power exceeds the limit, a red “F” is placed next to the dBc result to indicate a failure. If there are any failures, the pass/fail indicator area show “FAIL” in red; if there are none, it shows “PASS” in green. Any offsets that are in the off state (see “[Offset Freq or Edge Freq](#)” on [page 354](#)) are not measured and their results will not be displayed on screen.

Key Path: **Meas Setup**

State Saved: Saved in instrument state.

Factory Preset: Off

History: Updated with firmware revision A.03.00.
 Added with firmware revision A.02.00.

Remote Command:

```
[ :SENSE ] :ACPower:LIMit [ :STATe ] OFF | ON | 0 | 1
```

```
[ :SENSe ] :ACPower:LIMit [ :STATe ] ?
```

Example: ACP:LIM 1
 ACP:LIM?

5.6.11 RRC Filter

Pressing **Filter** turns the Root Raised Cosine filter on or off. This filter is the type specified in the NADC and 3GPP W-CDMA standards and is only available when **3GPP W-CDMA** or **NADC** is selected as the **Radio Std** from the **Mode Setup** menu. If **3GPP W-CDMA** is selected, the roll-off value (alpha) for the filter will be initially set to 0.22. T is set to 1/RefBW (default 260 ns). If **NADC** is selected, the roll-off will be initially set to 0.35. T is set to 1/RefBW (default 42 μs). If **TETRA** has been selected, the roll-off will be initially set to 0.35. T is set to 1/RefBW (default 55.6 μs). The roll-off value can be changed using **Filter Alpha**.

The filter is unavailable when the measurement method is set to **RBW**.

Key Path: **Meas Setup**

State Saved: Saved in instrument state.

Factory Preset: Off

History: Added with firmware revision A.03.00.

Remote Command:

```
[ :SENSE] :ACPower:FILTer [:RRC] [:STATe] OFF|ON|0|1  
[:SENSE]:ACPower:FILTer[:RRC][:STATe]?
```

Example: ACP:FILT 1
 ACP:FILT?

5.6.12 Filter Alpha

Press **Filter** to input the alpha value for the RRC Filter. This parameter is available when **3GPP W-CDMA**, **NADC**, or **TETRA** has been selected as the Radio Std. from the Mode Setup menu.

Key Path: **Meas Setup**

State Saved: Saved in instrument state.

Factory Preset: 0.22 when W-CDMA is selected, 0.35 when NADC or TETRA is selected, otherwise Off.

Knob Increment: 0.01

Step Key
Increment: 0.1

Range: 0.01 to 1.0

History: Added with firmware revision A.03.00.

Remote Command:

```
[ :SENSE] :ACPower:FILTer [:RRC] :ALPHA <number>  
[:SENSE]:ACPower:FILTer[:RRC]:ALPHA?
```

Example: ACP:FILT:ALPH 0.22
 ACP:FILT:ALPH?

5.6.13 Noise Correction

Pressing **Noise Correction** turns noise correction **on** or **off**. When you set **Noise Corr** to **On**, a calibration of the noise floor is performed and used to correct for analyzer noise floor contribution to measurement levels, increasing dynamic range.

Noise Correction is unavailable if signal tracking is on, or when the radio standard is set to **NADC** or **PDC** when the measurement method is set to **RBW**.

Key Path: **Meas Setup,**

State Saved: Saved in instrument state.

Factory Preset: Off

History: Added with firmware revision A.02.00.

Remote Command:

```
[ :SENSe ] :ACPower:CORRection:NOISe [ :AUTO ] OFF | ON | 0 | 1
```

```
[ :SENSe ] :ACPower:CORRection:NOISe [ :AUTO ] ?
```

Remote Command Notes: The noise correction feature is not available when the radio standard is set to NADC or PDC

Example: ACP:CORR:NOIS 1

ACP:CORR:NOIS?

5.7 Trace/View (ACP Measurement)

If **ACP** has been selected in the **Measure** menu of the Spectrum Analysis mode, this key displays the appropriate **Trace/View** menu for the adjacent channel power (ACP) measurement.

Displays menu keys that enable you to set how trace information is stored and displayed.

Key Path: Front-panel key

Factory Preset: Spectrum

History: Added with firmware revision A.02.00

Remote Command:

There is no equivalent remote command for this function.

5.7.1 Spectrum

Pressing **Spectrum** selects the spectral display of the measurement.

Key Path: **Trace/View**

Factory Preset: Spectrum

History: Added with firmware revision A.02.00

Remote Command:

There is no remote command for this function.

5.7.2 Bar Graph

Pressing **Bars** turns the graphic bar display on or off.

Key Path: **Trace/View**

Factory Preset: Spectrum

History: Added with firmware revision A.02.00

Remote Command:

There is no remote command for this function.

5.7.3 Combined

Pressing **Combined** selects the measurement to be displayed as a bar graph and spectrum as shown below.

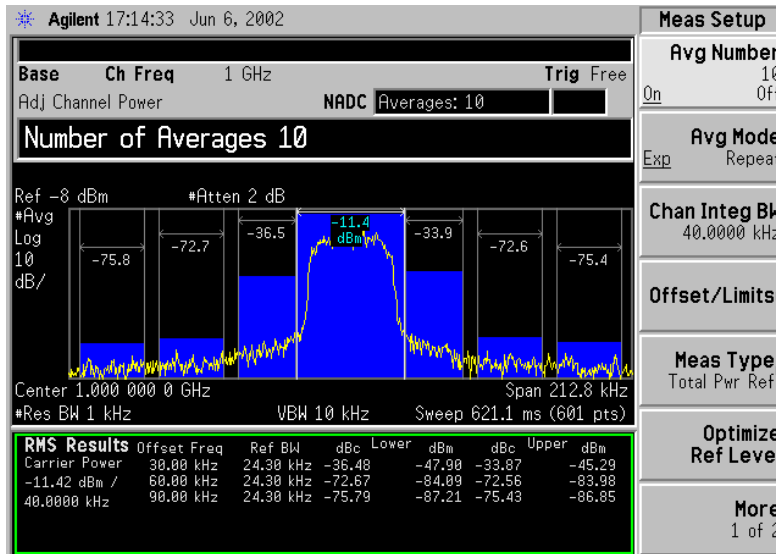

Key Path: **Trace/View**

Factory Preset: Spectrum

History: Added with firmware revision A.02.00

Remote Command:

There is no remote command for this function.

5.7.4 Combined View Units

Pressing **Combined View Units** selects the units (dBc or dBm) for the floating numeric displays when **Combined** is selected.

Key Path: **Trace/View**

Factory Preset: dBc

History: Added with firmware revision A.02.00

Remote Command:

There is no remote command for this function.

5.7.5 Trace

One-button measurements do not change this function. See [“Trace” on page 284](#) for more

information.

5.7.5.1 Trace (1 2 3)

Determines which trace the menu keys will affect. Press **Trace 1 2 3** until the number of the desired trace is underlined.

Key Path: **Trace/View, Trace**

State Saved: Saved in Instrument State for all traces

History: Added with firmware revision A.02.00

Remote Command:

```
:TRACe [1] | 2 | 3 :MODE WRITe | MAXHold | MINHold | VIEW | BLANk
```

WRITe = **Clear Write**

MAXHold = **Max Hold**

MINHold = **Min Hold**

VIEW = **View**

BLANk = **Blank**

```
:TRACe [1] | 2 | 3 :MODE?
```

Example: TRAC:MODE WRIT
 TRAC:MODE MAXH
 TRAC:MODE MINH
 TRAC:MODE VIEW
 TRAC:MODE BLANk
 TRAC:MODE?

5.7.5.2 Clear Write

See [“Clear Write” on page 285](#) for more information.

5.7.5.3 Max Hold

See [“Max Hold” on page 285](#) for more information.

5.7.5.4 Min Hold

See [“Min Hold” on page 285](#) for more information.

5.7.5.5 View

See [“View” on page 286](#) for more information.

5.7.5.6 Blank

See “Blank” on page 286 for more information.

5.8 Meas Setup (Burst Power)

When **Burst Power** has been selected in the **Measure** menu of the Spectrum Analysis Mode, this key displays the appropriate measurement setup menu.

The burst power measurement is an accurate method of determining the average power for the specified burst.

Key Path: Front-panel key

History: Added with firmware revision A.02.00

Remote Command:

There is no equivalent remote command.

5.8.1 Avg Number

Press **Avg Number (On)** to specify the number of measurement averages used when calculating the measurement result. The average is displayed at the end of each sweep.

Key Path: **Meas Setup**

State Saved: Saved in instrument state.

Factory Preset: 10 averages / Off

Range: 1 to 1000

History: Added with firmware revision A.02.00

Remote Command:

```
[ :SENSe ] :BPOWer:AVERAge:COUNt <integer>
```

```
[ :SENSe ] :BPOWer:AVERAge:COUNt?
```

```
[ :SENSe ] :BPOWer:AVERAge [ :STATe ] OFF | ON | 0 | 1
```

```
[ :SENSe ] :BPOWer:AVERAge [ :STATe ] ?
```

Example: BPOW:AVER:COUN 100

```
BPOW:AVER ON
```

5.8.2 Avg Mode

Press **Avg Mode** to select the type of termination control used for the averaging function to either **Exp** or **Repeat**. This determines the averaging action after the specified number of measurements (average count) is reached.

- **EXP** (Exponential Averaging mode)—When you set **Avg Mode** to **Exp**, each successive data acquisition after the average count is reached is exponentially weighted and combined with the existing average. Exponential averaging weights new data more than old data, which facilitates tracking of slow-changing signals. The average will be displayed at the end of each sweep.
- **Repeat**—When you set **Avg Mode** to **Repeat**, after reaching the average count, all previous result data is cleared and the average count is set back to 1.

Key Path: **Meas Setup**

State Saved: Saved in instrument state.

Factory Preset: EXPOnential

Range: EXPOnential | REPeat

History: Added with firmware revision A.02.00.

Remote Command:

```
[ :SENSe] :BPOWer:AVERAge:TCONrol EXPOnential | REPeat
```

```
[ :SENSe] :BPOWer:AVERAge:TCONrol?
```

Example: BPOW:AVG:TCON EXP
BPOW:AVG:TCON?

5.8.3 Average Type

Allows you to specify the type of result averaging to be performed.

- **Log** — Selects averaging that sums the trace data and divides by the number of data points.
- **RMS** — Selects averaging that converts trace data from dB to power units, then averages the power trace data. This selection requires more time to perform.

Key Path: **Meas Setup**

Factory Preset: RMS

Range: RMS or Log

History: Added with firmware revision A.02.00

Remote Command:

```
[ :SENSe] :BPOWer:AVERAge:TYPe LPOWer | POWer
```

[:SENSe] :BPOWer :AVERAge :TYPE?

Example: BPOW:AVG:TYP LPOWER to select Log type.
 BPOW:AVG:TYP?

5.8.4 Threshold Lvl

Enables you to set the level above which the mean carrier power calculation is based. The threshold level can be described in dB (**Rel**) or dBm (**Abs**).

Key Path: **Meas Setup**

Factory Preset: -30 dB

Terminators: dB or dBm

Default Terminator dB

Knob Increment: 0.1 dB/dBm

Step Key

Increment: 6 dB/dBm

Range: -60 dBm to 60 dBm (in absolute mode)
 -60 dB to 0 dB (in relative mode)

History: Added with firmware revision A.02.00

Remote Command:

[:SENSe] :BPOWer :THReshold <number>

[:SENSe] :BPOWer :THReshold?

[:SENSe] :BPOWer :THReshold :TYPE ABSolute | RELative

[:SENSe] :BPOWer :THReshold :TYPE?

Example: SENS:BPOW:THR:TYPE ABS

5.8.5 Meas Method

Allows you to select the measurement method.

- **Above Threshold Lvl** — Selects the user defined threshold level or default level (-3.00 dB) as the criteria in making the measurement.
- **Measured Burst Width** — This measurement method is not available for the following radio standards: IS-95, J-STD-008, cdma2000-SR1, cdma2000-SR3, W-DCMA 3GPP.

NOTE The measurements described above are those available in SA mode (see **Mode** key). Other measurements are available in other modes if an optional personality is installed.

Key Path: **Meas Setup**

Factory Preset: Above Threshold Lvl (THReshold)

Range: Measured Burst Width (BWIDth) to Above Threshold Lvl (THReshold)

History: Added with firmware revision A.02.00

Remote Command:

[:SENSE] :BPOWer:METhod THReshold|BWIDth

[:SENSe] :BPOWer:METhod?

Example: BPOW:METh BWID to select burst width as the measurement method.

5.8.6 Burst Width

Sets the burst width parameter to automatic mode (**Auto**) or manual mode (**Man**).

- **Auto** — The burst width is automatically calculated based on the threshold level. For example, if the threshold level is set to 3 dB, the burst width will be the time between the two 3 dB points. This will update after each sweep, but before any results are calculated. Since the measurement only measures over the burst width, this will force a measurement between the 3 dB points.
- **Man** — The burst width used for computing the burst power is controlled by either entering it directly or as a percentage of the measured burst width. In the percentage case, the burst width is computed just once based on the most recent measured burst width. In either case, the burst width is centered on the observed burst in each measurement.

NOTE This key will be greyed out if **Meas Method** is set to **Above Threshold Lvl**.

Key Path: **Meas Setup**

Factory Preset: 542.77 μ s

Terminators: %, s, ms, μ s, ns (% from front panel only)

Default Terminator: seconds (s)

Knob Increment: 0.1 μ s

Step Key

Increment: 10 μ s

Range: 0.1 μ s to 2 ks
History: Added with firmware revision A.02.00

Remote Command:

```
[ :SENSe] :BPOWer:BURSt:WIDTh <time>  
[ :SENSe] :BPOWer:BURSt:WIDTh?  
[ :SENSe] :BPOWer:BURSt:AUTO OFF|ON|0|1  
[ :SENSe] :BPOWer:BURSt:AUTO?
```

Remote Command Notes: Burst width cannot be set remotely as a percent of the current burst width. That functionality is available from the front panel, but the command must be sent with a time value.

Example: SENS:BPOW:BURST:AUTO ON

5.8.7 Optimize Ref Level

Sets the input attenuator to optimize the robustness of the measurement, which is its freedom from errors due to input compression.

NOTE There will always be a minimum of 6 dB of attenuation set to protect the analyzer input.

Key Path: **Meas Setup**
State Saved: Saved in instrument state.
Factory Preset: n/a
History: Added with firmware revision A.02.00.

Remote Command:

```
[ :SENSe] :POWer[:RF] :RANGe:AUTO ONCE
```

Example: POW:RANG:AUTO ONCE

5.9 Trace/View (Burst Power)

If **Burst Power** has been selected in the **Measure** menu of the Spectrum Analysis mode, this key displays the appropriate **Trace/View** menu for the burst power measurement.

Displays menu keys that enable you to set how trace information is stored and displayed.

Key Path: Front-panel key

Remote Command:

There is no remote command for this key.

5.9.1 RF Envelope

Press **RF Envelope** to view the measurement results as shown in the following figure. The results are updated after each sweep.

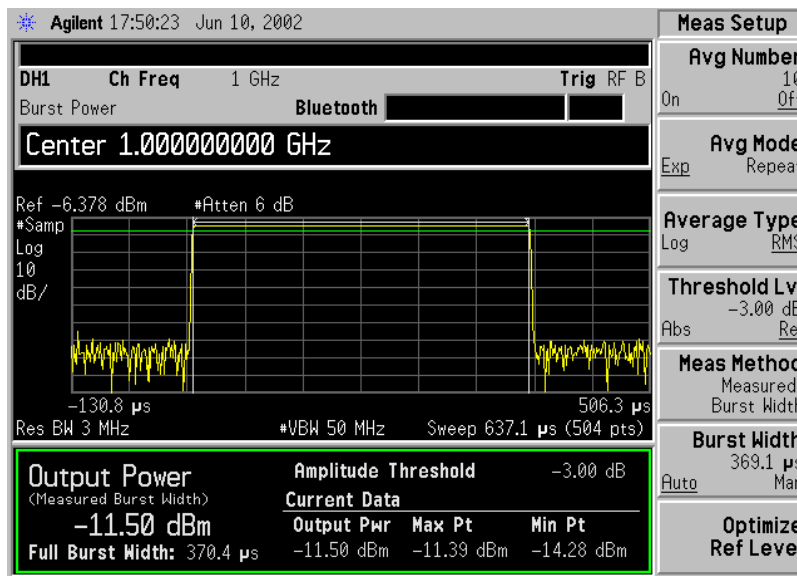

Key Path: Trace/View

History: Added with firmware revision A.02.00

5.9.2 Combined

Pressing **Combined** displays measurement results the same as RF Envelope, but has a blue bar between the markers to indicate the measured output power level. The actual measured output power is displayed at the bottom of the bar. Refer to the following figure.

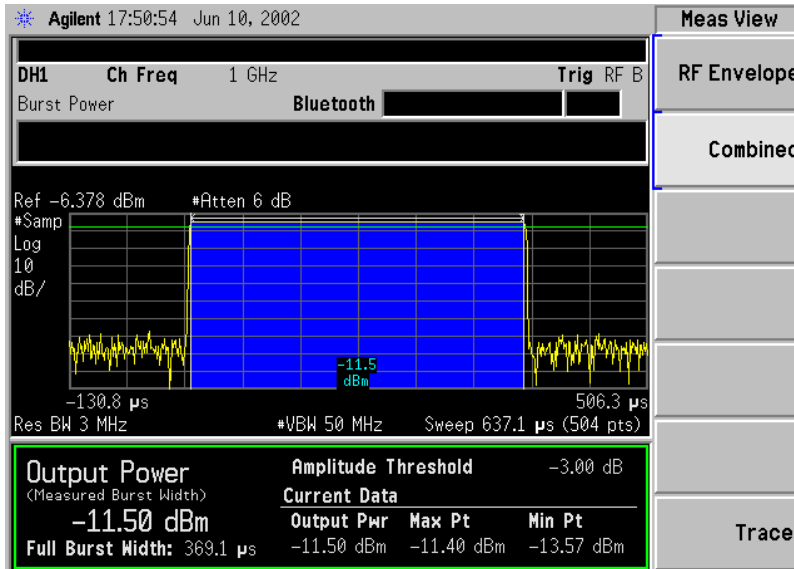

Key Path: **Trace/View**

History: Added with firmware revision A.02.00

5.9.3 Trace

One-button measurements do not change this function. See “Trace” on page 284 for more information.

5.9.3.1 Trace (1 2 3)

Determines which trace the menu keys will affect. Press **Trace 1 2 3** until the number of the desired trace is underlined.

Key Path: **Trace/View, Trace**

State Saved: Saved in Instrument State for all traces

History: Added with firmware revision A.02.00

Remote Command:

:TRACe [1] | 2 | 3 :MODE WRITe | MAXHold | MINHold | VIEW | BLANK

WRITe = **Clear Write**

MAXHold = **Max Hold**

MINHold = **Min Hold**

VIEW = **View**

BLANk = **Blank**

:TRACe [1] | 2 | 3 :MODE?

Example: TRAC:MODE WRIT
 TRAC:MODE MAXH
 TRAC:MODE MINH
 TRAC:MODE VIEW
 TRAC:MODE BLANk
 TRAC:MODE?

5.9.3.2 Clear Write

See “Clear Write” on page 285 for more information.

5.9.3.3 Max Hold

See “Max Hold” on page 285 for more information.

5.9.3.4 Min Hold

See “Min Hold” on page 285 for more information.

5.9.3.5 View

See “View” on page 286 for more information.

5.9.3.6 Blank

See “Blank” on page 286 for more information.

5.10 Meas Setup (Complementary Cumulative Distribution Function—CCDF)

When **Power Stat CCDF** has been selected in the **Measure** menu of the Spectrum Analysis mode, this key displays the appropriate measurement setup menu for the complementary cumulative distribution function (CCDF).

Power Complementary cumulative distribution function (CCDF) curves characterize the higher-level power of the signal. It provides the distribution of peak-to-average power ratios versus probability. A CCDF curve is defined by how much time the waveform spends at or above the specified power level. The percent of time the signal spends at or above this level defines the probability for that particular power level.

Key Path: Front-panel key

History: Added with firmware revision A.02.00

Remote Command:

There is no equivalent remote command.

5.10.1 Meas BW

Press **Meas BW** to set the measurement 3 dB bandwidth. The range is 10 kHz to 8 MHz, using the available RBW filters.

Key Path: **Meas Setup**

State Saved: Saved in instrument state.

Factory Preset: Defined by the radio standard selected.

Terminators: Hz, kHz, MHz, GHz

Knob Increment: Steps through available Res BW filters.

Step Key

Increment: Steps through available Res BW filters.

Range: Lowest non-zero Span supported by Analyzer to the maximum Span of the ESA

History: Added with firmware revision A.02.00

Remote Command:

```
[ :SENSE ] :PStatistic:BANDwidth|BWIDth <freq>
```

```
[ :SENSE ] :PStatistic:BANDwidth|BWIDth?
```

Remote Command Notes: The entered value is rounded to the nearest Res BW filter frequency.

Example: PST:BAND 10 or PST:BWID 10
PST:BAND? or PST:BWID?

5.10.2 Counts

Press **Counts** to set the accumulated number of sampling points for data acquisition. The range is 1 kpoints (kilopoint–1000 points) to 2.000000 Gpoints (Giga point– 10^9 point) with 1 kpoint resolution. While this key is activated, enter a value from the numeric keypad by terminating with one of the unit keys shown.

Key Path: **Meas Setup**
State Saved: Saved in instrument state.
Factory Preset: 1.00e5
Range: 1e3 to 1e9
History: Added with firmware revision A.02.00

Remote Command:

```
[[:SENSe]]:PStatistic:COUNTs <integer>  
[[:SENSe]]:PStatistic:COUNTs?
```

Example: PST:COUN 1.0e6
PST:COUNt?

5.10.3 Meas Interval

Press **Meas Interval** to specify the time interval over which the measurement is made. The minimum setting is 100 μ s. The maximum setting depends on the measurement bandwidth setting but never exceeds 600 ms. The resolution is 1 μ s.

Key Path: **Meas Setup**
State Saved: Saved in instrument state.
Factory Preset: 1.0ms
Default Terminator: s
Range: 100 μ s to 600 ms
History: Added with firmware revision A.02.00

Remote Command:

[:SENSE] :PStatistic:SWEep:TIME <time>

[:SENSE] :PStatistic:SWEep:TIME?

Example: PST:SWE:TIME 1.0e-3

PST:SWE:TIME?

5.10.4 Optimize Ref Level

Sets the input attenuator to optimize the robustness of the measurement, which is its freedom from errors due to input compression.

NOTE There will always be a minimum of 6 dB of attenuation set to protect the analyzer input.

Key Path: **Meas Setup**

State Saved: Saved in instrument state.

Factory Preset: n/a

Range: n/a

History: Added with firmware revision A.02.00

Remote Command:

[:SENSE] :POWer [:RF] :RANGe:AUTO ONCE

Example: POW:RANG:AUTO ONCE

5.11 Display (Complementary Cumulative Distribution Function—CCDF)

Press **Display** to access menu keys that allow you to configure parameters for the CCDF measurement.

NOTE The keys described below are measurement dependent. To access the display menus, for the CCDF measurement press **Measure**, **Power Stat CCDF**, then **Display**.

5.11.1 Full Screen

Expands the measurement window horizontally over the entire instrument display. Pressing any other key that results in a new menu cancels the full screen function.

Any error occurring turns full screen mode off.

Key Path: **Display**

Key Path: **Display**

State Saved: Not saved in state.

Factory Preset: Off

Factory
Default: Off

History: Added with firmware revision A.02.00

5.11.2 Store Ref Trace

Press **Store Ref Trace** to copy the currently measured curve as the user-definable reference trace. The captured data will remain until the other mode is chosen. Pressing this key refreshes the reference trace.

Key Path: **Display**

Factory Preset: n/a

Remote Command:

:CALCulate:PStatistic:STORe:REFeRence

Example: CALC:PST:STOR:REF

5.11.3 Ref Trace

Press **Ref Trace** to toggle the reference trace display function between **On** and **Off**.

Key Path: **Display**

State Saved: Saved in instrument state.

Factory Preset: Off

Remote Command:

```
:DISPlay:PStatistic:REFErence[:STATe] OFF|ON|0|1
```

```
:DISPlay:PStatistic:REFErence[:STATe]?
```

Example: PST:REF 1

PST:REF?

5.11.4 Gaussian Trace

Press **Gaussian Line** to toggle the Gaussian line display function between **On** and **Off**.

Key Path: **Display**

State Saved: Saved in instrument state.

Factory Preset: Off

Remote Command:

```
:DISPlay:PStatistic:GAUSSsian[:STATe] OFF|ON|0|1
```

```
:DISPlay:PStatistic:GAUSSsian[:STATe]?
```

Example: PST:GAUS 1

PST:GAUS?

5.11.5 Preferences

Displays the menu key that enables you to turn the graticule and annotation on or off.

Key Path: **Display**

State Saved: Saved in instrument state.

Factory Preset: No title

Fundamental

Units: N/A

History: Added with firmware revision A.02.00

5.11.5.1 Graticule

Pressing Graticule turns the display graticules **On** or **Off**.

Key Path: **Display, Preferences**

Factory Preset: On

Factory
Default: On

Terminators: Enter

History: Added with firmware revision A.02.00

5.12 SPAN X Scale (Complementary Cumulative Distribution Function—CCDF)

Activates the Span function for the CCDF measurement and displays the menu of span functions.

Key Path: Front-panel key

State Saved: Saved in Instrument State

Remote Command:

See the [Scale/Div](#) command below.

5.12.1 Scale/Div

Allows you to enter a numeric value to change the horizontal display sensitivity by setting the decibel units per horizontal graticule division.

Key Path: MEASURE, Power Stat CCDF, SPAN X Scale

State Saved: Saved in instrument state.

Factory Preset: 2.0 dB

Default Terminator: dB

Range: 0.1 to 20.00 dB with 0.01 dB resolution

Remote Command:

```
:DISPlay:PStatistic:XScale<rel_ampl>
```

```
:DISPlay:PStatistic:XScale?
```

Example DISP:PST:XSC 10 dB

 DISP:PST:XSC?

One-Button Measurement Functions
SPAN X Scale (Complementary Cumulative Distribution Function—CCDF)

5.13 Marker (Complementary Cumulative Distribution Function—CCDF)

Displays the Marker control menu for the CCDF measurement. All markers are off until either **Normal** or **Delta** is pressed. There are three control modes for the markers:

- **Normal (POSITION)** - A single marker placed at the 0 dB point of the selected value of **Marker Trace** that can be moved to any point on the trace.
- **Delta (DELTA)** - Places the selected marker and the next marker at the position of the previous marker on the specified trace (selected by pressing **Marker Trace**). The next marker is the reference marker (set to normal) and the selected marker is a moveable marker (delta) that you can place at any point on the trace. The difference between the selected marker and the reference marker is displayed.
- **Off (OFF)** - Turns off the active marker.

Key Path: Front-panel key

State Saved: The control mode for each marker, as well as the position of each marker, is saved in instrument state.

Factory Preset: All Off.

History: Added with firmware revision A.02.00

Remote Command:

There is no equivalent remote command. These commands control the three marker modes. Refer to the Normal, Delta, and Off key descriptions for additional information.

```
:CALCulate:PStatistic:MARKer [1] | 2 | 3 | 4 :MODE NORMal | DELTa | OFF
```

```
:CALCulate:PStatistic:MARKer [1] | 2 | 3 | 4 :MODE?
```

Remote Command Notes: See also the marker positioning commands:

[“Marker X Position” on page 395](#)

[“Marker Y Position \(Remote Command Only\)” on page 396](#)

[“Marker Maximum and Minimum \(Remote Command Only\)” on page 397](#)

Example: `CALC:PST:MARK:MODE DELT` activates a delta marker (marker 1) at the 0 dB point of your measurement (yellow line).

5.13.1 Select Marker

Selects one of the four possible markers. Once a marker is selected, it can be set to any of the control modes **Normal**, **Delta**, or **Off**.

Key Path: **Marker** (after **MEASURE**, **Power Stat CCDF** is selected.)

State Saved: The number of the selected marker is saved in instrument state.

Factory Preset: Marker 1

Remote Command:

```
:CALCulate:PStatistic:MARKer [1] | 2 | 3 | 4 [:STATe] OFF | ON | 0 | 1
```

```
:CALCulate:PStatistic:MARKer [1] | 2 | 3 | 4 [:STATe] ?
```

Sets or queries the state of a marker. Setting a marker to state ON or 1 selects that marker. Setting a marker which is OFF to state ON or 1 puts it in **Normal** mode and places it at the center of the display. Setting a marker to state OFF or 0 selects that marker and turns it off. The response to the query will be 0 if OFF, 1 if ON.

Example: `CALC:PST:MARK2 ON` selects marker 2.

`CALC:PST:MARK:STAT ON` will not modify a marker that is already on.

5.13.2 Normal

Sets the control mode for the selected marker to **Normal**. If the marker is off, a single marker is activated at the 0 dB point of the selected trace (see [“Marker Trace” on page 394](#)). You can then adjust the selected marker using the numeric keypad, knob, or \uparrow \downarrow keys.

Key Path: **Marker** (after **MEASURE**, **Power Stat CCDF** is selected.)

Factory Preset: Off

Remote Command:

See [“Marker” on page 177](#) for the mode command.

Example: `CALC:PST:MARK:MODE NORM` selects marker 1 and sets it to **Normal**.

5.13.3 Delta

Sets the control mode for the selected marker to **Delta**. In **Delta** mode the display shows the difference between the active (**Delta**) marker and a reference marker. When **Delta** mode is selected the reference marker is placed at the current marker position, unless the marker was **OFF**, in which case both the active marker and the reference marker are placed at 0 dB point of the selected trace (see [“Marker Trace” on page 394](#)). You can adjust the trace point of the active delta marker. Annotation in the active function block and in the upper-right corner of the display indicates the power ratio (dB) difference and probability (percentage) difference of the two markers.

Key Path: Marker (after MEASURE, Power Stat CCDF is selected.)

Remote Command:

See “Marker” on page 177 for the mode command.

Example: `CALC:PST:MARK3:MODE DELT` selects marker 3 as a delta marker and places a reference marker at the 0 dB point on the specified trace (see “Marker Trace” on page 394). If marker 3 is OFF it places both the active and the reference markers at the 0 dB point of the specified trace.

5.13.4 Off

Turns off the selected marker. In addition, **Off** also turns off functions related to the selected marker.

Key Path: Marker (after MEASURE, Power Stat CCDF is selected.)

Remote Command:

See “Select Marker” on page 180 for the command to select the control mode.

Example:

`CALC:PST:MARK3:STAT OFF` selects marker 3 and sets it to **Off**.

5.13.5 Marker Trace

Chooses which trace the selected marker will be placed on. You can pick **Measured**, **Gaussian**, or **Reference**.

Key Path: Marker (after MEASURE, Power Stat CCDF is selected.)

State Saved: The **Marker Trace** for each marker is saved in instrument state.

Factory Preset: Measured

Remote Command:

`:CALCulate:PStatistic:MARKer [1] | 2 | 3 | 4:TRACe MEASured|GAUSSian|REFerence`

Puts the marker on the specified trace.

`:CALCulate:PStatistic:MARKer [1] | 2 | 3 | 4:TRACe?`

The query returns the type of the trace on which the marker currently resides.

Example: `CALC:PST:MARK1:TRAC GAUSSian` places marker 1 on the Gaussian trace.

5.13.6 Marker All Off

Turns off all markers.

NOTE Selecting any measurement (including **Meas Off**) under **Measure**, turns off the marker table.

Key Path: Marker (after MEASURE, Power Stat CCDF is selected.)

Remote Command:

:CALCulate:PSTatistic:MARKer [1] | 2 | 3 | 4 :AOFF

Example: CALC:PST:MARK:AOFF turns off all markers.

5.13.7 Marker X Position

Sets the marker X position (horizontal) to a specified point on the X axis in the current X-axis units (dB). If the value chosen would place the marker off screen, the marker will be placed at the left or right side of the display, on the specified trace (see “[Marker Trace](#)” on [page 394](#)). If the marker is off, this command has no effect.

Key Path: **Marker**

Key Notes: When a marker is active, you may use the knob, numeric keypad, or ↑ ↓ keys to specify the horizontal location of the marker.

Terminators: dB

Step Key Increment: 1 dB

Range: 0 to 50 dB

History: Added in A.02.00

Remote Command:

:CALCulate:PSTatistic:MARKer [1] | 2 | 3 | 4 :X <dB>

Sets the marker X position in the current X-axis units (dB).

:CALCulate:PSTatistic:MARKer [1] | 2 | 3 | 4 :X?

Queries the marker X position in the current x-axis units. For the response to be valid, the marker must be on.

:CALCulate:PSTatistic:MARKer [1] | 2 | 3 | 4 :X:POSition <dB>

:CALCulate:PSTatistic:MARKer [1] | 2 | 3 | 4 :X:POSition?

This defines marker X position in display points from 0 to 50 dB.

Example: CALC:PST:MARK:X 30 dB activates a normal marker (marker 1) at the 30 dB location on the specified trace (see “[Marker Trace](#)” on [page 394](#)).

CALC:PST:MARK2:X:POS 10 selects marker 2 and moves it to 1 dB location on the specified trace.

5.13.8 Marker Y Position (Remote Command Only)

Displays the marker Y position (vertical) of the specified trace (see “[Marker Trace](#)” on [page 394](#)) in the current Y-axis units (percent).

History: Added in A.02.00

Remote Command:

```
:CALCulate:PSTatistic:MARKer [1] | 2 | 3 | 4 :Y?
```

Queries the marker Y value or delta in the current y axis units. The marker must be **ON** for the response to be valid.

Example: CALC:PST:MARK1:Y?

5.13.9 Marker Maximum and Minimum (Remote Command Only)

Moves the marker to the maximum or minimum detected amplitude value on the display. If the marker is off, this command has no effect.

History: Added in A.02.00

Remote Command:

```
:CALCulate:PSTatistic:MARKer [1] | 2 | 3 | 4 :MAXimum
```

```
:CALCulate:PSTatistic:MARKer [1] | 2 | 3 | 4 :MINimum
```

Example: CALC:PST:MARK:MAX
 CALC:PST:MARK3:MIN

5.14 Meas Setup (Channel Power—CHP)

When the channel power measurement has been selected in the **Measure** key menu of the Spectrum Analysis Mode, this key displays the appropriate measurement setup menu.

The Channel Power measurement measures the power and power spectral density in the channel bandwidth that you specify. One marker pair on the display indicates the edges of the channel bandwidth. The center frequency, reference level, and channel bandwidth must be set by the user.

Key Path: Front-panel key
 Dependencies/
 Couplings: Menu changes depending on the Mode and Measurement selected.
 State Saved: No save
 History: Added with firmware revision A.02.00

Remote Command:

There is no equivalent remote command.

5.14.1 Avg Number

To specify the number of measurement averages used when calculating the measurement result set **Avg Number** to **On**. The average will be displayed at the end of each sweep. Setting **Avg Number** to **Off** disables measurement averaging.

Key Path: **Meas Setup**
 State Saved: Saved in instrument state.
 Factory Preset: 10 averages/ Off
 Knob Increment: 1
 Step Key
 Increment: 1
 Range: 1 to 1000

Remote Command:

```
[ :SENSe ] :CHPower:AVERage:COUNT <integer>
[ :SENSe ] :CHPower:AVERage:COUNT?

[ :SENSe ] :CHPower:AVERage [ :STATe ] OFF | ON | 0 | 1
[ :SENSe ] :CHPower:AVERage [ :STATe ] ?
```

Example: CHP: AVER: COUN 10
 CHP: AVER: COUN?
 CHP: AVER OFF
 CHP: AVER?

5.14.2 Avg Mode

Press **Avg Mode** to select the type of termination control used for the averaging function to either **Exp** or **Repeat**. This determines the averaging action after the specified number of measurements (average count) is reached.

- **EXP** (Exponential Averaging mode)—When you set **Avg Mode** to **Exp**, each successive data acquisition after the average count is reached is exponentially weighted and combined with the existing average. Exponential averaging weights new data more than old data, which facilitates tracking of slow-changing signals. The average will be displayed at the end of each sweep.
- **Repeat**—When you set **Avg Mode** to **Repeat**, after reaching the average count, all previous result data is cleared and the average count is set back to 1.

Key Path: **Meas Setup**

State Saved: Saved in instrument state.

Factory Preset: EXPonential

Remote Command:

```
[ :SENSe ] :CHPower: AVERage: TCONrol EXPonential | REPeat
```

```
[ :SENSe ] :CHPower: AVERage: TCONrol ?
```

Example: CHP: AVG: TCON EXP
 CHP: AVG: TCON?

5.14.3 Integ BW

Press **Integ BW** to specify the range of integration used in calculating the power in the channel, for example. set the main (center) channel bandwidth. Note that the integration bandwidth is displayed on the trace as two markers connected by an arrow. Be sure the **Span** of the instrument is set between 1 and 10 times the integration bandwidth.

Key Path: **Meas Setup**

Key Notes: If **RRC Filter** is on, the actual integration bandwidth used is the displayed integration bandwidth multiplied by (1 + “[Filter Alpha](#)”).

State Saved: Saved in instrument state.

Factory Preset: 2 MHz, or as defined by the selected radio standard.

Terminators: GHz, MHz, kHz, Hz

Default Terminator: Hz

Knob Increment: 1%

Step Key

Increment: 1, 1.5, 2, 3, 5, 7.5, 10...

Range: 100 Hz to maximum span supported by your analyzer.

Remote Command:

```
[ :SENSe ] :CHPower:BANDwidth|BWIDth:INTEgration <freq>
```

```
[ :SENSe ] :CHPower:BANDwidth|BWIDth:INTEgration?
```

Example: CHP:BAND:INT 1 MHz

```
CHP:BAND:INT?
```

5.14.4 Chan Pwr Span

Press **Chan Pwr Span** to set the analyzer span for the channel power measurement. When the **RRC Filter** is set to **On**, the lower limit for the span is $(1 + \alpha) \times \text{Integration BW}$.

Key Path: **Meas Setup**

State Saved: Saved in instrument state.

Factory Preset: 3 MHz, or as defined by the selected radio standard.

Default Terminator: Hz

Knob Increment: 1, 1.5, 2, 3, 5, 7.5, 10...

Step Key

Increment: 1%

Range: Current integration bandwidth to 10 times the integration bandwidth or span of your analyzer.

Remote Command:

```
[ :SENSe ] :CHPower:FREQuency:SPAN <freq>
```

```
[ :SENSe ] :CHPower:FREQuency:SPAN?
```

Example: CHP:FREQ:SPAN 2 MHz

```
CHP:FREQ:SPAN?
```

5.14.5 Optimize Ref Level

Sets the input attenuator to optimize the robustness of the measurement, which is its freedom from errors due to input compression.

NOTE There will always be a minimum of 6 dB of attenuation set to protect the analyzer input.

Key Path: **Meas Setup**

State Saved: Not saved.

Remote Command:

[:SENSe] :POWer [:RF] :RANGe :AUTO ONCE

Example: POW:RANG:AUTO ONCE

5.14.6 RRC Filter

Pressing **RRC Filter** turns the Root Raised Cosine filter on or off. This filter is the type specified in the TETRA and 3GPP W-CDMA standards. This parameter is only available when either **3GPP W-CDMA** or **TETRA** has been selected as the **Radio Std** from the **Mode Setup** menu. If **3GPP W-CDMA** is selected, the roll-off value (alpha) for the filter will be initially set to 0.22. T is set to 1/RefBW (default 260 ns). If **TETRA** is selected, the roll-off will be initially set to 0.35. T is set to 1/RefBW (default 55.56 μ s). The roll-off value can be changed using **Filter Alpha**.

Key Path: **Meas Setup**

State Saved: Saved in instrument state.

Factory Preset: Off

History: Added with firmware revision A.03.00.

Remote Command:

[:SENSe] :CHPower :FILTer [:RRC] [:STATe] OFF | ON | 0 | 1

[:SENSe] :CHPower :FILTer [:RRC] [:STATe] ?

Example: CHP:FILT 1

CHP:FILT?

5.14.7 Filter Alpha

Press **RRC Filter** to input the alpha value for the RRC Filter. This parameter is only available when either **3GPP W-CDMA** or **TETRA** has been selected as the Radio Std. from the Mode Setup menu.

Key Path: **Meas Setup**

State Saved: Saved in instrument state.

Factory Preset: 0.22 when W-CDMA is selected, 0.35 for TETRA, otherwise Off.

Knob Increment: 0.01

Step Key

Increment: 0.1

Range: 0.01 to 1.0

History: Added with firmware revision A.03.00.

Remote Command:

```
[ :SENSe ] :CHPower :FILTer [ :RRC ] :ALPHA <number>
```

```
[ :SENSe ] :CHPower :FILTer [ :RRC ] :ALPHA?
```

Example: `CHP:FILT:ALPH 0.22`

`CHP:FILT:ALPH?`

5.15 Trace/View (Channel Power Measurement)

If **Channel Power** has been selected in the **Measure** menu of the Spectrum Analysis mode, this key displays the appropriate **Trace/View** menu for the channel power measurement.

Displays menu keys that enable you to set how trace information is stored and displayed.

Key Path: Front-panel key

Factory Preset: Spectrum

History: Added with firmware revision A.02.00

Remote Command:

There is no equivalent remote command for this function.

5.15.1 Spectrum

Pressing **Spectrum** selects the spectral display of the measurement.

Key Path: **Trace/View**

Factory Preset: Spectrum

History: Added with firmware revision A.02.00

Remote Command:

There is no remote command for this function.

5.15.2 Combined

Pressing **Combined** selects the measurement to be displayed as a bar graph and spectrum.

Key Path: **Trace/View**

Factory Preset: Spectrum

History: Added with firmware revision A.02.00

Remote Command:

There is no remote command for this function.

5.15.3 Trace

One-button measurements do not change this function. See [“Trace” on page 284](#) for more information.

5.15.3.1 Trace (1 2 3)

Determines which trace the menu keys will affect. Press **Trace 1 2 3** until the number of the desired trace is underlined.

Key Path: **Trace/View, Trace**

State Saved: Saved in Instrument State for all traces

History: Added with firmware revision A.02.00

Remote Command:

:TRACe [1] | 2 | 3 :MODE WRITe | MAXHold | MINHold | VIEW | BLANk

WRITe = **Clear Write**

MAXHold = **Max Hold**

MINHold = **Min Hold**

VIEW = **View**

BLANk = **Blank**

:TRACe [1] | 2 | 3 :MODE?

Example: TRAC:MODE WRIT

TRAC:MODE MAXH

TRAC:MODE MINH

TRAC:MODE VIEW

TRAC:MODE BLANk

TRAC:MODE?

5.15.3.2 Clear Write

See “[Clear Write](#)” on page 285 for more information.

5.15.3.3 Max Hold

See “[Max Hold](#)” on page 285 for more information.

5.15.3.4 Min Hold

See “[Min Hold](#)” on page 285 for more information.

5.15.3.5 View

See “[View](#)” on page 286 for more information.

5.15.3.6 Blank

See “Blank” on page 286 for more information.

5.16 Meas Setup (Harmonic Distortion)

When the harmonic distortion measurement has been selected in the Measure key menu of the Spectrum Analysis Mode, this key displays the appropriate measurement setup menu.

Key Path: Front-Panel key

Saved State: Not saved.

5.16.1 Avg Number

Press **Avg Number (On)** to specify the number of measurement averages used when calculating the measurement result. The average will be displayed at the end of each sweep.

Key Path: Meas Setup

State Saved: Saved in instrument state.

Factory Preset: 10 averages / Off

Range: 1 to 1000

Remote Command:

```
[ :SENSe ] :HARMonics :AVERAge :COUNT <integer>
```

```
[ :SENSe ] :HARMonics :AVERAge :COUNT ?
```

```
[ :SENSe ] :HARMonics :AVERAge [ :STATe ] OFF | ON | 0 | 1
```

```
[ :SENSe ] :HARMonics :AVERAge [ :STATe ] ?
```

Example: HARM:AVER:COUN 100

HARM:AVER ON

5.16.2 Avg Mode

Press **Avg Mode** to select the type of termination control used for the averaging function to either **Exp** or **Repeat**. This determines the averaging action after the specified number of measurements (average count) is reached.

- **EXP** (Exponential Averaging mode)—When you set **Avg Mode** to **Exp**, each successive data acquisition after the average count is reached is exponentially weighted and combined with the existing average. Exponential averaging weights new data more than old data, which facilitates tracking of slow-changing signals. The average will be displayed at the end of each sweep.

- **Repeat**—When you set **Avg Mode** to **Repeat**, after reaching the average count, all previous result data is cleared and the average count is set back to 1.

Key Path: **Meas Setup**

State Saved: Saved in instrument state.

Factory Preset: EXPonential

Range: EXPonential | REPeat

History: Added with firmware revision A.02.00.

Remote Command:

```
[ :SENSE ] :HARMonics:AVERAge:TCONrol EXPonential | REPeat
```

```
[ :SENSE ] :HARMonics:AVERAge:TCONrol?
```

Example: HARM:AVG:TCON EXP

HARM:AVG:TCON?

5.16.3 Harmonics

Harmonics indicates the number of harmonics to measure before computing the total harmonic distortion. The minimum number is 2 (only the fundamental and second harmonic will be measured). The maximum number is 10.

Key Path: **Meas Setup**

State Saved: Saved in instrument state.

Factory Preset: 10

Range: 2 to 10

Remote Command:

```
[ :SENSE ] :HARMonics:NUMBer <integer>
```

```
[ :SENSE ] :HARMonics:NUMBer?
```

Example: HARM:NUMB 5

5.16.4 ST/Harmonic

Sets the sweep time used to measure each harmonic. The value is set to 200 divided by the resolution bandwidth, or 10 ms, whichever is greater when the measurement is started. This sweep time is used only for measuring harmonics. The analyzer sweep time before the measurement was started is used for finding the fundamental.

Key Path: **Meas Setup**

State Saved: Saved in instrument state.

Factory Preset: 10 ms / Auto

Default Terminator: seconds

Range: 10 ms to maximum sweep time of the analyzer

Remote Command:

```
[ :SENSe ] :HARMonics :SWEeptime :STATe OFF | ON | 0 | 1
```

```
[ :SENSe ] :HARMonics :SWEeptime :STATe ?
```

```
[ :SENSe ] :HARMonics :SWEeptime <time>
```

```
[ :SENSe ] :HARMonics :SWEeptime ?
```

Remote Command Notes: ON is equal to automatic (Auto). OFF is equal to manual (Man).

Example: HARM:SWE:STAT OFF
HARM:SWE 100 ms

5.16.5 Range Table (On/Off)

Press Range Table to specify whether the range table is to be used or not. When **Range Table** is set to **Off** the harmonics are measured. When **Range Table** is set to **On** the first active range is considered to be the fundamental and the subsequent active ranges are used as the harmonics. At least two ranges must be active if **Range Table** is set to **On**.

Key Path: Meas Setup

Factory Preset: See [Table 5-1 on page 414](#).

Range: Off | On

History: Added with firmware revision A.03.00

Remote Command:

```
[ :SENSe ] :HARMonics :RTABLE :STATe OFF | ON | 0 | 1
```

```
[ :SENSe ] :HARMonics :RTABLE :STATe ?
```

Example: HARM:RTAB:STAT OFF

5.16.6 Range Table

Enables you to enter the settings for up to 10 ranges, either using the instrument front panel keys or remotely. Upon entering the range table, the measurement stops, then the analyzer is set to a constantly sweeping state. The analyzer is then set to the current values for range 1 (whether range 1 is on or off). If a range is currently off, the values in the range table for that range are replaced with --- (see Range 5 in the illustration) to indicate this range is currently inactive.

Range	Center Freq	Span	Res BW	Video BW	Sweep Time
1	50.00 MHz	0.000 Hz	100.0 kHz	100.0 kHz	10.00 ms
2	100.0 MHz	0.000 Hz	100.0 kHz	2.000 kHz	10.00 ms
3	150.0 MHz	0.000 Hz	100.0 kHz	2.000 kHz	10.00 ms
4	200.0 MHz	0.000 Hz	100.0 kHz	2.000 kHz	10.00 ms
5	---	---	---	---	---

NOTE You can edit the range table at anytime by pressing any front-panel key except the following: **Esc**, **System**, **File**, **Save**, **Print Setup**, **Print**, **Marker**, **Peak Search**, **Freq Count**, **Next Marker**, **Next Window**, or **Zoom**.

Key Path: **Meas Setup**

Saved State: All values for all ranges are saved in instrument state.

Factory Preset: For each range, the following settings are selected: **Range State**(On), **Zero Span**, **Res BW Mode**(Man), **Video BW**(Man) is set to 2 kHz, and **Sweep Time Mode**(Auto) is set to 10 ms. The table below defines the other default parameter settings for the measurement.

Table 5-1 Range Table Default Settings

Range	Center Freq (GHz)	Res BW (kHz)
1	1.000	100.0
2	2.000	200.0
3	3.000	300.0
4	4.000	430.0
5	5.000	510.0
6	6.000	620.0
7	7.000	750.0
8	8.000	820.0
9	9.000	910.0
10	10.00	1000.0

History: Added with firmware revision A.03.00

Remote Command:

There is no equivalent remote command.

5.16.6.1 Range

Selects a range and updates the values on the other **Range Table** keys so that they reflect the settings for the selected range. If **Range** is set to **On** it is used as part of the measurement; when set to **Off** it is excluded. A range is made up of the next parameters.

Key Path: **Meas Setup, Range Table**

Factory Preset: See [Table 5-1 on page 414](#).

Range: Off | On

Remote Command:

This parameter can send up to 10 values. The location in the list sent corresponds to the range the value is associated with. Missing values are not permitted. For example, if you want to change values 2 and 6, you must send all values up to 6. Subsequent values remain as they were.

```
[ :SENSE ] :HARMonics:RANGe [ :LIST ] :STATe OFF | ON | 0 | 1
```

The query for this parameter will always return 20 values.

```
[ :SENSE ] :HARMonics:RANGe [ :LIST ] :STATe?
```

Example: HARM:RANG:LIST:STAT ON, OFF, ON, ON

5.16.6.2 Center Freq

Used to set the center frequency of the analyzer.

Key Path: **Meas Setup, Range Table**

Factory Preset: See [Table 5-1 on page 414](#).

Knob Increment: 1%

Step Key

Increment: 1, 1.5, 2, 3, 5, 7.5, 10, ...

Range: Frequency range of your analyzer.

History: Added with firmware revision A.03.00

Remote Command:

This parameter can send up to 10 values. The location in the list sent corresponds to the range the value is associated. Missing values are not permitted, for example, if you want to change values 2 and 6, you must send all values up to 6. Subsequent values will remain as they were.

```
[ :SENSE ] :HARMonics:RANGe [ :LIST ] :FREQuency <integer>
```

The query for this parameter will always return 10 values.

```
[ :SENSE ] :HARMonics:RANGe [ :LIST ] :FREQuency?
```

Example: HARM:RANG:LIST FREQ 300

5.16.6.3 Span

Span is used to set the span of the analyzer.

Key Path: **Meas Setup, Range Table**

Factory Preset: See [Table 5-1 on page 414](#).

Knob Increment: Steps through the available spans.

Step Key

Increment: Steps through the available spans.

Range: Span of your analyzer.

History: Added with firmware revision A.03.00

Remote Command:

This parameter can send up to 10 values. The location in the list sent corresponds to the range the value is associated with. Missing values are not permitted, for example, if you want to change values 2 and 6, you must send all values up to 6. Subsequent values will remain as they were.

```
[ :SENSE ] :HARMONICS :RANGE [ :LIST ] :SPAN
```

```
[ :SENSE ] :HARMONICS :RANGE [ :LIST ] :SPAN?
```

5.16.6.4 Res BW

Res BW is used to set the resolution bandwidth mode of the analyzer. If the range is zero span and **Res BW** is set to **Auto**, the analyzer determines the optimum setting. **Res BW** set to **Man** enables you to determine the setting.

Key Path: **Meas Setup, Range Table**

Factory Preset: See [Table 5-1 on page 414](#).

Knob Increment: Steps through the available resolution bandwidth filters.

Step Key

Increment: Steps through the available resolution bandwidth filters.

Range: Resolution bandwidth range of your analyzer.

History: Added with firmware revision A.03.00

Remote Command:

This parameter can send up to 10 values. The location in the list sent corresponds to the range the value is associated with. Missing values are not permitted, for example, if you want to change values 2 and 6, you must send all values up to 6. Subsequent values will remain as they were.

```
[ :SENSE ] :HARMONICS :RANGE [ :LIST ] :BWIDTh | BANDwidth [ :RESolution ] :AUTO
```

```
OFF | ON | 0 | 1
```

selects the mode.

```
[ :SENSE ] :HARMONICS :RANGE [ :LIST ] :BWIDTh | BANDwidth [ :RESolution ] <integer>
```

The query for this parameter always returns 10 values.

```
[ :SENSE ] :HARMONICS :RANGE [ :LIST ] :BWIDTh | BANDwidth [ :RESolution ] :AUTO?
```



```
[ :SENSe ] :HARMonics :RANGe [ :LIST ] :BWIDth | BANDwidth [ :RESolution ] ?
```

5.16.6.5 Video BW

Video BW is used to set the video bandwidth of the analyzer. When **Auto** is selected the analyzer determines the optimum setting, while **Man** enables you to determine the setting.

Key Path: **Meas Setup, Range Table**

Factory Preset: Auto

Knob Increment: Steps through the available video bandwidth filters.

Step Key

Increment: Steps through the available video bandwidth filters.

Range: Video bandwidth range of your analyzer.

History: Added with firmware revision A.03.00

Remote Command:

This parameter can send up to 10 values. The location in the list sent corresponds to the range the value is associated with. Missing values are not permitted, for example, if you want to change values 2 and 6, you must send all values up to 6. Subsequent values will remain as they were.

`[:SENSE] :HARMONICS :RANGE [:LIST] :BWIDTh | BANDwidth :VIDeo :AUTO OFF | ON | 0 | 1`
selects the mode.

`[:SENSE] :HARMONICS :RANGE [:LIST] :BWIDTh | BANDwidth :VIDeo <integer>`

The query for this parameter will always return 10 values.

`[:SENSE] :HARMONICS :RANGE [:LIST] :BWIDTh | BANDwidth :VIDeo :AUTO?`

`[:SENSE] :HARMONICS :RANGE [:LIST] :BWIDTh | BANDwidth :VIDeo?`

5.16.6.6 Sweep Time

Sweep Time is used to set the sweep time of the analyzer. If the range is zero span and **Sweep Time** is set to **Auto**, the sweep time will be 200 divided by the resolution bandwidth or 10 ms, whichever is greater. If the range is non zero span and **Sweep Time** is set to **Auto**, the analyzer determines the optimum setting. **Sweep Time** set to **Man** enables you to determine the setting.

Key Path: **Meas Setup, Range Table**

Factory Preset: Auto

Knob Increment: 1%

Step Key

Increment: 1, 1.5, 2, 3, 5, 7.5, 10, ...

Range: Sweep time range of your analyzer.

History: Added with firmware revision A.03.00

Remote Command:

This parameter can send up to 10 values. The location in the list sent corresponds to the range the value is associated with. Missing values are not permitted, for example, if you want to change values 2 and 6, you must send all values up to 6. Subsequent values will remain as they were.

```
[ :SENSe] :HARMonics:RANGe [:LIST] :SWEep:TIME:AUTO OFF|ON|0|1 selects the mode.
```

```
[ :SENSe] :HARMonics:RANGe [:LIST] :SWEep:TIME: <integer>
```

The query for this parameter will always return 10 values.

```
[ :SENSe] :HARMonics:RANGe [:LIST] :SWEep:TIME:AUTO?
```

```
[ :SENSe] :HARMonics:RANGe [:LIST] :SWEep:TIME?
```

5.16.6.7 Auto Fill Range Table

Auto Fill Range Table is used to automatically setup the range table based on the current range center frequency and span. When selected, the current center frequency is taken as the fundamental and the frequency in range one is set to this value. Each of the subsequent range center frequency parameters are set to the appropriate integer multiple of the fundamental frequency. The span for range one is set to that of the current range. Each of the subsequent range span parameters are set to the appropriate integer multiple of the fundamental span. This means that if the fundamental range is zero span, all the ranges will be zero span. If the range span is zero, **Res BW**, **Video BW**, and **Sweep Time** are set to the current base instrument settings. If the range span is non-zero, **Res BW**, **Video BW**, and **Sweep Time** for all harmonics are set to the same settings as for the fundamental. Span is set to zero for all harmonics and the fundamental.

Key Path: **Meas Setup, Range Table**

Knob Increment: 1%

Step Key

Increment: 1, 1.5, 2, 3, 5, 7.5, 10, ...

Range: Sweep time range of your analyzer.

History: Added with firmware revision A.03.00

Remote Command:

```
[ :SENSe] :HARMonics:RTABle:FILL <no query>
```

Example: HARM:RTAB:FILL

5.16.7 Optimize Ref Level

Sets the input attenuator to optimize the robustness of the measurement, which is its freedom from errors due to input compression.

NOTE There will always be a minimum of 2 dB of attenuation set to reduce the

potential errors due to VSWR.

Key Path: **Meas Setup**

State Saved: Saved in instrument state.

History: Added with firmware revision A.02.00.

Remote Command:

[:SENSe] :POWer [:RF] :RANGe :AUTO ONCE

Example: POW:RANG:AUTO ONCE

5.17 Trace/View (Harmonics)

If **Harmonic Distortion** has been selected in the **Measure** menu of the Spectrum Analysis mode, this key displays the appropriate **Trace/View** menu to view the harmonic measurement results.

Displays menu keys to view the harmonic measurement results in two views, **Harmonic** and **Harmonic & THD**.

Key Path: Front-panel key

History: Modified with firmware revision A.03.00
Added with firmware revision A.02.00

5.17.1 Harmonics

Press **Harmonics** to view the measurement results in numeric form.

Key Path: **Trace/View**

5.17.2 Harmonics & THD

Press **Harmonics & THD** to view the measurement results in numeric form, as well as the total harmonic distortion (THD) displayed as a percentage and as a dB value.

Key Path: **Trace/View**

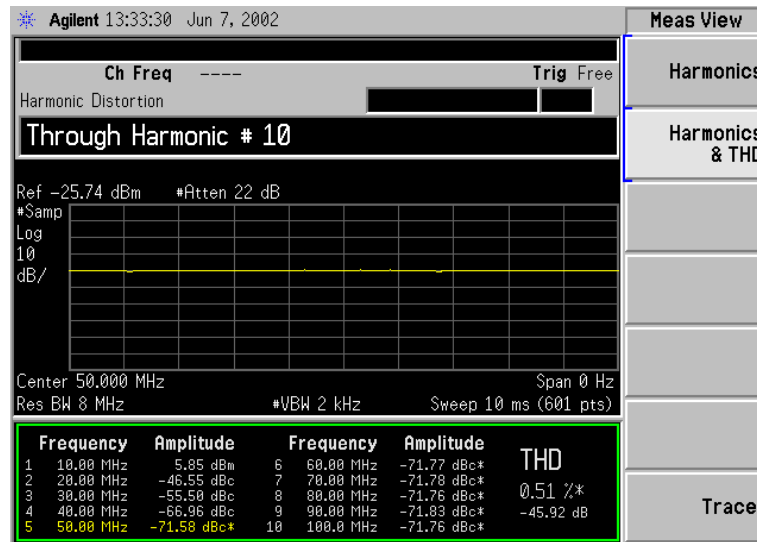

5.18 Meas Setup (Intermod (TOI))

When **Intermod (TOI)** measurement has been selected in the **Measure** menu of the Spectrum Analysis Mode, this key displays the appropriate measurement setup menu for third order intercept (TOI).

The TOI measurement computes and displays the output intercept point (IP3), and places markers upon the trace to indicate the measured signals and third-order products.

Key Path: Front-panel key

Dependencies/

Couplings: Menu changes depending on the Mode and Measurement selected.

History: Added with PSA firmware revision A.02.00

Remote Command:

There is no equivalent remote command.

5.18.1 Avg Number

Set **Avg Number** to On to specify the number of measurement averages used when calculating the measurement result. The average will be displayed at the end of each sweep. Setting **Avg Number** to Off disables measurement averaging.

Key Path: **Meas setup**

State Saved: Saved in instrument state.

Factory Preset: 10 averages / Off

Range: 1 through 1000

History: Added with PSA firmware revision A.02.00

Remote Command:

```
[ :SENSe ] :TOIN:AVERAge:COUNT <integer>
```

```
[ :SENSe ] :TOIN:AVERAge:COUNT?
```

```
[ :SENSe ] :TOIN:AVERAge [ :STATe ] OFF | ON | 0 | 1
```

```
[ :SENSe ] :TOIN:AVERAge [ :STATe ] ?
```

Example: TOIN:AVER ON

TOIN:AVER?

5.18.2 Avg Mode

Press **Avg Mode** to select the type of termination control used for the averaging function to either **Exp** or **Repeat**. This determines the averaging action after the specified number of measurements (average count) is reached.

- **EXP** (Exponential Averaging mode)—When you set **Avg Mode** to **Exp**, each successive data acquisition after the average count is reached is exponentially weighted and combined with the existing average. Exponential averaging weights new data more than old data, which facilitates tracking of slow-changing signals. The average will be displayed at the end of each sweep.
- **Repeat**—When you set **Avg Mode** to **Repeat**, after reaching the average count, all previous result data is cleared and the average count is set back to 1.

Key Path: **Meas Setup**

State Saved: Saved in instrument state.

Factory Preset: EXPonential

History: Added with PSA firmware revision A.02.00

Remote Command:

```
[ :SENSe] :TOIN:AVERAge:TCONrol EXPonential|REPEAT
```

```
[ :SENSe] :TOIN:AVERAge:TCONrol?
```

Example: TOIN:AVG:TCON EXP
 TOIN:AVG:TCON?

5.18.3 TOI Span

Press **Span** to specify the frequency span in which intermodulation products are measured.

Key Path: **Meas Setup**

Key Note: If you modify the value of Span in the base instrument Span menu, the value in the Meas Setup menu will be updated to reflect the new value and the measurement will restart if it is running.

Factory Preset: 15 MHz, or as defined by the radio standard selected.

Range: Non-Zero Span of Analyzer

History: Added with PSA firmware revision A.02.00

Remote Command:

```
[ :SENSe] :TOIN:FREQuency:SPAN <number>
```

```
[ :SENSe] :TOIN:FREQuency:SPAN?
```

Example: TOIN:FREQ:SPAN 20 MHz
TOIN:FREQ:SPAN?

5.18.4 Max Mixer Lvl

Enables you to set the relationship between the highest signal that can be displayed (the reference level) and the input attenuation. The relationship applies whenever the **Attenuation** is set to **Auto**. The relationship is that the attenuation is given by reference level minus the max mixer level. For example, as the reference level changes, the input attenuator changes to ensure that a signal at the reference level does not exceed the **Max Mixer Lvl** setting.

When the TOI measurement is on, this key controls the maximum mixer level, independent of the previous setting of **Max Mixer Lvl** located under **Amplitude**. When the TOI measurement is **Off**, the previous maximum **Max Mixer Lvl** is restored.

Setting **Max Mixer Lvl** to **Auto** sets the maximum mixer level to -30 dBm.

Key Path: **Meas Setup**

Factory Preset: -30.00 dBm/Auto

Range:

History: Added with PSA firmware revision A.02.00

Remote Command:

```
[ :SENSE ] :TOIN:FREQuency:MIXer:RANGe [:UPPer] <number>
```

```
[ :SENSe ] :TOIN:FREQuency:MIXer:RANGe [:UPPer] ?
```

```
[ :SENSe ] :TOIN:FREQuency:MIXer:RANGe:AUTO OFF|ON|0|1
```

```
[ :SENSe ] :TOIN:FREQuency:MIXer:RANGe:AUTO?
```

Example: TOIN:FREQ:MIX:RANG -10 dBm
TOIN:FREQ:MIX:RANG?
TOIN:FREQ:MIX:RANG:AUTO 1
TOIN:FREQ:MIX:RANG:AUTO?

5.18.5 Optimize Ref Level

Sets the reference level to place the tones near the top of the display. When input attenuation is set to **Auto**, pressing **Optimize Ref Level** sets the input attenuation according to the auto rules described in [Max Mixer Lvl](#), based on this reference level. You may want to trade off analyzer noise and analyzer-induced distortion by manually changing the attenuation setting from this starting point.

NOTE There is always a minimum of 6 dB of attenuation set to protect the analyzer input.

Key Path: **Meas Setup**

State Saved: Saved in instrument state.

History: Added with PSA firmware revision A.02.00

Remote Command:

```
[ :SENSe ] :POWer [ :RF ] :RANGe :AUTO ONCE
```

Example: TOIN:RANG:AUTO ONCE

```
TOIN:RANG:AUTO?
```

5.19 Meas Setup (Multi-Carrier Power—MCP)

If the MCP measurement has been selected in the **Measure** menu of the Spectrum Analysis mode, this key displays the MCP measurement setup menu.

The Multi-Carrier Power measurement is a measure of the power in two or more transmit channels and of the power that leaks into their adjacent transmit channels. The results reported are similar to the adjacent channel power measurement, but the setup is different to allow for two or more carriers present.

Key Path: Front-panel key

Dependencies/

- Couplings:
- Parameter defaults change depending on the Radio Standard selected.
 - Sweep time is coupled to span, RBW, and VBW if the measurement method is set to IBW.

History: Added with firmware revision A.02.00

Remote Command:

There is no equivalent remote command.

5.19.1 Avg Number

Pressing **Avg Number** to **On** enables you to specify the number of measurements that will be averaged when calculating the measurement result. The average will be displayed at the end of each sweep. Setting **Avg Number** to **Off** disables the measurement averaging.

Key Path: **Meas Setup**

State Saved: Saved in instrument state.

Factory Preset: 10 / Off

Range: 1 through 1000

History: Added with firmware revision A.02.00

Remote Commands:

```
[ :SENSe ] :MCPower:AVERage:COUNT <integer>
```

```
[ :SENSe ] :MCPower:AVERage:COUNT?
```

```
[ :SENSe ] :MCPower:AVERage [ :STATe ] OFF | ON | 0 | 1
```

```
[ :SENSe ] :MCPower:AVERage [ :STATe ] ?
```

Example: MCP:AVER:COUN 10

```
MCP:AVER:COUN?
```

MCP: AVER OFF

MCP: AVER?

5.19.2 Avg Mode

Press **Avg Mode** to select the type of termination control used for the averaging function as either **Exp** or **Repeat**. This determines the averaging action after the specified number of measurements (average count) is reached.

- **EXP** (Exponential Averaging mode)—When you set **Avg Mode** to **Exp**, each successive data acquisition after the average count is reached is exponentially weighted and combined with the existing average. Exponential averaging weights new data more than old data, which facilitates tracking of slow-changing signals. The average will be displayed at the end of each sweep.
- **Repeat**—When you set **Avg Mode** to **Repeat**, after reaching the average count, all previous result data is cleared and the average count is set back to 1.

Key Path: **Meas Setup**

State Saved: Saved in instrument state.

Factory Preset: Exponential

History: Added with firmware revision A.02.00

Remote Command:

```
[ :SENSe ] :MCPower :AVERage :TCONrol EXPonential | REPeat
```

```
[ :SENSe ] :MCPower :AVERage :TCONrol ?
```

Example: MCP:AVG:TCON EXP

MCP:AVG:TCON?

5.19.3 Carrier Setup

Accesses the Carrier Setup and Configure Carriers menus that allow you to define the various parameters for each carrier.

Key Path: **Meas Setup**

History: Added with firmware revision A.03.00.

Remote Command:

There is no equivalent remote command.

5.19.3.1 Carriers

Press **Carriers** to specify the number of carriers to be measured.

Key Path: **Meas Setup, Carrier Setup**

Factory Preset: 4

Step Key

Increment: 1

Range: 2 to 12

History: Added with firmware revision A.03.00.

Remote Command:

```
[ :SENSe] :MCPower:CARRier:COUNT<integer>
```

```
[ :SENSe] :MCPower:CARRier:COUNT?
```

Example: MCP:CARR:COUN 10

```
MCP:CARR:COUN?
```

5.19.3.2 Ref Carrier

Press **Ref Carrier (Man)** to specify the carrier (identified by a numeric position) from which all relative power measurements will be made. When **Ref Carrier** is set to **Auto**, the analyzer selects the carrier with the highest power as the reference.

Key Path: **Meas Setup, Carrier Setup**

Key Notes: The carrier must have power present in order to be assigned as a reference carrier frequency. If you change the reference carrier's power present value from "yes" to "no", the next carrier to the left (or to the right, if there are none to the left) will be assigned as the reference carrier. If it currently has power present set to No, this will change to Yes. This is also true when there are only two carriers with a "yes" value. Refer to the "[Carrier Pwr Present](#)" key description for more information on setting the carrier power present value.

Factory Preset: Auto

Range: Auto/Man
1 to 12

History: Added with firmware revision A.03.00.

Remote Command:

```
[ :SENSe] :MCPower:RCARrier:AUTO OFF|ON|0|1
```

```
[ :SENSe] :MCPower:RCARrier:AUTO?
```

```
[ :SENSe] :MCPower:RCARrier<integer>
```

One-Button Measurement Functions
Meas Setup (Multi-Carrier Power—MCP)

```
[ :SENSe ] :MCPower:RCARrier?
```

Remote Command Notes: Refer to “Key Notes:” above.

Example: MCP:RCAR:AUTO ON
 MCP:RCAR 3
 MCP:RCAR?

5.19.3.3 Ref Carrier Freq

Press **Ref Carrier Freq (Man)** to select the reference carrier frequency for this measurement. The center frequency is then calculated using the algorithm below:

1. Cntr Freq 1 = Ref Freq – [0.5 (Carrier Width of Ref Carrier)]
2. Cntr Freq 2 = Cntr Freq 1– (Total of all Carrier Widths excluding the Ref Carrier Width)
3. Cntr Freq = Cntr Freq 2 + [(Total of all Carrier Widths)/2]

Pressing **Ref Carrier Freq (Auto)** distributes the carriers evenly around the current center frequency. The reference carrier frequency is then calculated using the algorithm below:

1. Ref Freq 1 = Cntr Freq – [(Total of all Carrier Widths)/2]
2. Ref Freq 2 = Ref Freq 1+ (Total of all Carrier Widths excluding the Ref Carrier Width)
3. Ref Freq = Ref Freq 2 + [0.5 (Carrier Width of Ref Carrier)]

The above procedure ensures carrier visibility on the analyzer display.

Key Path: **Meas Setup, Carrier Setup**

Dependencies/

Couplings: The reference carrier can be re-assigned by implementing changes to carrier power present values.

State Saved: Saved in instrument state.

Factory Preset: Auto/Calculated based on current center frequency. Refer to the [“algorithm”](#) above when defining the **Ref Carrier Freq(Auto)** key.

Terminators: Hz, kHz, MHz, GHz

Default Terminator GHz

Resolution: 1 Hz

Knob Increment: Span ÷ 50

Step Key

Increment: If **CF Step(Auto)** is selected: span/10.
 If **CF Step(Man)** is selected: CF Step

Range: Analyzer minimum to analyzer maximum

History Added with firmware revision A.03.00.

Remote Command:

```
[ :SENSe] :MCPower:RCFrequency<Freq>
```

```
[ :SENSe] :MCPower:RCFrequency?
```

```
[ :SENSe] :MCPower:RCFrequency:AUTO OFF|ON|0|1
```

```
[ :SENSe] :MCPower:RCFrequency:AUTO?
```

Example: MCP:RCFR 2 GHz
MCP:RCFR?

5.19.3.4 Configure Carriers

Accesses the Config Carriers menu that allows further definition of each carrier.

Key Path: **Meas Setup, Carrier Setup**

History: Added with firmware revision A.03.00.

Remote Command:

There is no equivalent remote command.

5.19.3.4.1 Carrier

Selects the carrier number you wish to configure.

Key Path: **Meas Setup, Carrier Setup, Configure Carriers**

Dependencies/

Couplings: All keys available on the Configure Carrier key menu are coupled to this key.

State Saved: Saved in instrument state.

Factory Preset: 1

Knob Increment: 1

Step Key

Increment: 1

Range: 2 to 12

History: Added with firmware revision A.03.00.

Remote Command:

There is no equivalent remote command.

5.19.3.4.2 Carrier Pwr Present

Press **Carrier Pwr Present (Yes)** to specify carriers which have power present. First, press the **Carrier** key and select the carrier number you wish to define, using the Step Keys (\downarrow \uparrow), the knob, or the numeric keypad. (The carrier number selected is shown on the **Carrier** key.) Then toggle the **Carrier Pwr Present** key to indicate either yes or no.

If a carrier is defined as having no power present, the power displayed will be relative to the reference carrier. If a carrier is defined as having power present, the absolute power will be displayed.

Carriers with power present are included in the total carrier power result.

Key Path: Meas Setup, Carrier Setup, Configure Carriers

Dependencies/Couplings: This key assigns a value (yes or no) to the carrier number displayed on the **Carrier** key.

State Saved: Saved in instrument state.

Factory Preset: YES, YES, YES, YES

Range: Yes or No

History: Added with firmware revision A.03.00.

Remote Command:

```
[ :SENSe] :MCPower:CARRier:LIST:PPResent YES|NO
[ :SENSe] :MCPower:CARRier:LIST:PPResent?
```

Remote Command Notes:

- The position number in the list sent corresponds to the carrier number you are designating. For example: “YES, YES, NO, YES, YES, NO” defines six carriers. Carriers 1, 2, 4, and 5 are defined as having power present whereas carriers 3 and 6 do not have power present. If you need to change carrier 5, you must send all carriers up to 5. Carrier 6 will remain unchanged. If you send more values than the number of carriers specified using the **Carriers** key, (in this example, there are six carriers) they will be ignored.
- The query for this parameter returns the current value for all carriers (with and without power present).

Example: MCP:CARR:PPR YES,NO,YES,NO,YES
 MCP:CARR:PPR?

5.19.3.4.3 Carrier Width

Press **Carrier Width** to specify the width of each carrier including carriers with no power present. There is a corresponding one-to-one relationship between each carrier width value and the specified number of carriers. First, press the **Carrier** key and select the carrier number you wish to define, using the Step Keys (↓ ↑), the knob, or the numeric keypad. (The carrier number selected is shown on the **Carrier** key.) Then press the **Carrier Width** key and enter the width using the numeric keypad.

Key Path: Meas Setup, Carrier Setup, Configure Carriers

Key Notes: The **Carrier** key determines which carrier width you are defining.

State Saved: Saved in instrument state.

Factory Preset: 5 MHz, 5 MHz, 5 MHz, 5 MHz

Terminators: Hz, kHz, MHz, GHz

One-Button Measurement Functions
Meas Setup (Multi-Carrier Power—MCP)

Default Terminator: Hz

Resolution: 1 Hz

Step Key

Increment: If **CF Step**(Auto) is selected: span/10.
If **CF Step**(Man) is selected: CF Step

Range: 0 Hz to 45 MHz

History: Added with firmware revision A.03.00.

Remote Command:

```
[ :SENSe] :MCPower:CARRier:LIST:WIDTh <Hz>
[ :SENSe] :MCPower:CARRier:LIST:WIDTh?
```

Remote Command Notes:

- The position number of the each carrier width in the list sent corresponds to the carrier number you are defining. For example: “5 MHz, 10 MHz, 5 MHz” defines six carriers. Carriers 1, 2, 4, and 5 are defined as having power present whereas carriers 3 and 6 do not have power present. If you need to change carrier 5, you must send all carriers up to 5. Carrier 6 will remain unchanged. If you send more values than the number of carriers specified using the **Carriers** key, (in this example, there are six carriers) they will be ignored.
- The query for this parameter returns the current value for all carriers (with and without power present).

Example: MCP:CARR:LIST:WIDT 5 MHz,10 MHz,4 MHz,15 MHz,5 MHz,10 MHz
 MCP:CARR:LIST:WIDT?

5.19.3.4.4 Carrier IntegBW

Press **Carrier IntegBW** to define the integration bandwidth used to calculate the power in the carriers.

Key Path: Meas Setup, Carrier Setup, Configure Carriers

State Saved: Saved in instrument state.

SCPI Status Bits/

OPC Dependencies: The integration bandwidth is specified differently depending on the radio standard selected. If **Mode Setup, Radio Std, 3GPP W-CDMA** is selected and the RRC filter is on, the actual integration bandwidth used will be the displayed integration bandwidth multiplied by (1 + filter alpha).

Factory Preset: 3.84 MHz, 3.84 MHz, 3.84 MHz, 3.84 MHz

Terminators: Hz, kHz, MHz, GHz

Default Terminator Hz

Resolution:

Knob Increment: Span ÷ 50

Step Key

Increment: If **CF Step(Auto)** is selected: span/10.
 If **CF Step(Man)** is selected: CF Step

Range: 100 Hz to 20 MHz

History: Added with firmware revision A.03.00.

Remote Command:

[[:SENSe]:MCPower:CARRier:LIST:BANDwidth|BWIDth:[INTEgration]<Hz>

[[:SENSe]:MCPower:CARRier:LIST:BANDwidth|BWIDth:[INTEgration]?

Example: MCP:CARR:BAND 3.5MHz,2.85MHz,3.84MHz

5.19.4 Offsets/Limits

Displays menu keys that enable you to configure the offsets and limits for the MCP measurement.

Key Path: **Meas Setup**

History: Added with firmware revision A.02.00

Remote Command:

There is no equivalent remote command.

5.19.4.1 Offset

Enables you to select the offset the menu keys will affect. Press **Offset** until the letter of the desired offset (A, B, or C) is underlined.

Key Path: **Meas Setup, Offset/Limits**

Factory Preset: A

History: Added with firmware revision A.02.00

Remote Command:

There is no equivalent remote command.

5.19.4.2 Offset Freq

Sets the frequency difference between the center of the uppermost carrier and the center of the upper element of the offset pair, as well as the frequency difference between the center of the lower element of the offset pair and the center of the lowermost carrier. If you set the frequency of any offset to 0 Hz, the offset is turned off and not included in the displayed results.

Key Path: **Meas Setup, Offset/Limits**

State Saved: Saved in instrument state.

Factory Preset: 5 MHz, 10 MHz, 15 MHz

Terminators: Hz, kHz, MHz, GHz

Default Terminator: Hz

Range: 0 MHz to 45 MHz
 History: Added with firmware revision A.02.00

Remote Command:

```
[ :SENSe] :MCPower:OFFSet:LIST: [FREQuency] <Hz>, <Hz>, <Hz>
[ :SENSe] :MCPower:OFFSet:LIST: [FREQuency] ?
```

Example: MCP:OFFS:LIST:5MHz, 7.5MHz, 15MHz
 MCP:OFFS:LIST:?

5.19.4.3 Offset Integ BW

Sets the bandwidth over which the power is integrated for the selected offset (refer to “Offset” above).

Key Path: **Meas Setup, Offset/Limits**
 Key Notes: If **RRC Filter** is set to **On**, the actual integration bandwidth used is the displayed integration bandwidth multiplied by (1 + **Filter Alpha**).
 State Saved: Saved in instrument state.
 Factory Preset: 3.84 MHz, 3.84 MHz, 3.84 MHz
 Terminators: Hz, kHz, MHz, GHz
 Default Terminator: Hz
 Knob Increment: Span ÷ 50
 Step Key
 Increment: If **CF Step(Auto)** is selected: span/10
 If **CF Step(Man)** is selected: CF Step
 Range: 100 Hz to 20 MHz
 History: Added with firmware revision A.03.00

Remote Command:

```
[ :SENSe] :MCPower:OFFSet:LIST:BANDwidth|BWIDth: [INTEgration] <Hz>, <Hz>, <Hz>
[ :SENSe] :MCPower:OFFSet:LIST:BANDwidth|BWIDth: [INTEgration] <Hz>, <Hz>, <Hz>
```

Example: MCP:OFFS:LIST:BWIDth 5MHz, 3MHz, 5MHz
 MCP:OFFS:LIST:BWID?

5.19.4.4 Upper Offset Limit

Sets the limit for the selected offset (refer to “Offset” above) to the right of the carriers.

Key Path: **Meas Setup, Offset/Limits**
State Saved: Saved in instrument state.
Factory Preset: 0 dB, 0 dB, 0 dB
Default Terminator: dB
Knob Increment: 1
Step Key
Increment: 5
Range: -200 dB to 200 dB
History: Added with firmware revision A.03.00

Remote Command:

```
:CALCulate:MCPower:OFFSet:LIST:LIMit:POSitive[:UPPer]:DATA <dB>,<dB>,<dB>  
:CALCulate:MCPower:OFFSet:LIST:LIMit:POSitive[:UPPer]:DATA?
```

Example: `CALC:MCP:OFFS:LIST:LIM:POS:DATA -50dB,-55dB,-60dB`
`:CALC:MCP:OFFS:LIST:LIM:POS:DATA?`

5.19.4.5 Lower Offset Limit

Sets the limit for the selected offset (refer to “Offset” above) to the left of the carriers.

Key Path: **Meas Setup, Offset/Limits**
State Saved: Saved in instrument state.
Factory Preset: 0 dB, 0 dB, 0 dB
Default Terminator: dB
Knob Increment: 1
Step Key
Increment: 5
Range: -200 dB through 200 dB
History: Added with firmware revision A.03.00

Remote Command:

```
:CALCulate:MCPower:OFFSet:LIST:LIMit:NEGative[:UPPer]:DATA <dB>,<dB>,<dB>  
:CALCulate:MCPower:OFFSet:LIST:LIMit:NEGative[:UPPer]:DATA?
```

Example: `CALC:MCP:OFFS:LIST:LIM:NEG:DATA -50dB,-55dB,-60dB`
`CALC:MCP:OFFS:LIST:LIM:NEG:DATA?`

5.19.5 Carrier Result

Press **Carrier Result** to select the result you wish to display on the last line of the carrier power results list except when:

- the carrier result number ≤ 4 (the first 4 carrier power results are displayed)
- the carrier result number ≥ 9 (the last 4 carrier power results are displayed)

Key Path: **Meas Setup**

Key Notes: This key is only available when **Meas Control, Measure (Single)** is selected.

State Saved: Not saved.

Factory Preset: 1

Step Key
 Increment: 1

Range: 1 to number of carriers.

History Added with firmware revision A.03.00

Remote Command:

There is no equivalent remote command.

5.19.6 Optimize Ref Level

Sets the input attenuator to optimize the robustness of the measurement, which is its freedom from errors due to input compression.

NOTE There will always be a minimum of 2 dB of attenuation set to reduce the potential errors due to VSWR.

Key Path: **Meas Setup**

State Saved: Not saved.

History: Added with firmware revision A.02.00

Remote Command:

[:SENSE] :POWER [:RF] :RANGe:AUTO ONCE

Example: POW:RANG:AUTO ONCE

5.19.7 Method

Enables you to set the measurement method to either the integration bandwidth method (IBW) or the resolution bandwidth method (RBW). The resolution bandwidth method is

most useful for measuring cdmaOne and cdma2000 signals; the integration bandwidth method is preferred for other signals.

Key Path: **Meas Setup**

Key Notes: When Method is set to RBW, neither Noise Correction nor RRC Filter are available.

State Saved: Saved in instrument state.

Factory Preset: IBW

Range: IBW | RBW

History: Added with firmware revision A.02.00.

Remote Command:

```
[ :SENSe ] :MCPower :METHod IBW | RBW
```

```
[ :SENSe ] :MCPower :METHod ?
```

Example: MCP :METH RBW

MCP :METH ?

5.19.8 Power Ref

Enables you to set the multi-carrier power reference to automatic or manual. When set to automatic, the carrier power result reflects the measured power value in the selected reference carrier (**Meas Setup**, **Carrier Setup**, **Ref Carrier**). When set to manual, the result is referenced to the last measured value, or you may specify the reference for the multi-carrier power measurement. Relative values are displayed, referenced to the “Power Reference” value.

Key Path: **Meas Setup**

State Saved: Saved in instrument state.

Factory Preset: Off/Measured power in the reference carrier.

Terminators: dBm

Default Terminator: dBm

History: Added with firmware revision A.02.00.

Remote Command:

```
[ :SENSe ] :MCPower :CARRier :AUTO [ :STATe ] OFF | ON | 0 | 1
```

```
[ :SENSe ] :MCPower :CARRier :AUTO [ :STATe ] ?
```

```
[ :SENSe ] :MCPower :CARRier [ :POWer ] <dBm>
```

```
[ :SENSe ] :MCPower :CARRier [ :POWer ] ?
```

Example: MCP:CARR:AUTO 0
 MCP:CARR:AUTO?
 MCP:CARR -100
 MCP:CARR?

5.19.9 Limit Test

Pressing **Limit Test** turns the testing of the limit line on or off. When **Limit Test** is set to **On**, each offset is compared to its upper and lower offset limit. In those cases where the power exceeds the limit, a red “F” is placed next to the dBc result to indicate a failure. If there are any failures, the pass/fail indicator area show “FAIL” in red; if there are none, it shows “PASS” in green. Any offsets that are in the off state (see [“Offset Freq” on page 438](#)) are not measured and their results will not be displayed on screen.

Key Path: **Meas Setup, More**

State Saved: Saved in instrument state.

Factory Preset: Off

History: Added with firmware revision A.02.00

Remote Command:

```
[[:SENSE]:MCPower:LIMit[:STATE] OFF|ON|0|1
```

```
[[:SENSE]:MCPower:LIMit[:STATE] ?
```

Example: MCP:LIM ON

MCP:LIM?

5.19.10 RRC Filter

Pressing **RRC Filter** turns the Root Raised Cosine filter on or off for the carriers and all adjacent channels. The RRC filter is the type specified in the 3GPP W-CDMA standards, with roll-off (α) = **Filter Alpha** parameter (defined below). It is set to 1/Carrier Integ BW (for carriers) or 1/Offset Integ BW (for Offsets).

Key Path: **Meas Setup, More**

Key Notes: This key is not available when **Meas Setup, Method** (RBW) is selected.

State Saved: Saved in instrument state.

Factory Preset: Off

History: Added with firmware revision A.02.00

Remote Command:

```
[[:SENSE]:MCPower:FILTer[:RRC][:STATE] OFF|ON|0|1
```

```
[[:SENSE]:MCPower:FILTer[:RRC][:STATE] ?
```

Example: MCP:FILT 1

MCP:FILT?

5.19.11 Filter Alpha

Press **Filter** to input the alpha value for the RRC Filter. This parameter is only available when **3GPP W-CDMA** or **None** has been selected as the radio standard from the Mode Setup menu.

Key Path: **Meas Setup, More**

State Saved: Saved in instrument state.

Factory Preset: 0.22 when W-CDMA is selected, otherwise Off.

Range: Off/On

History: Added with firmware revision A.03.00.

Remote Command:

```
[ :SENSe] :MCPower:FILTer [:RRC] :ALPHA <number>
```

```
[ :SENSe] :MCPower:FILTer [:RRC] :ALPHA?
```

Example: MCP:FILT:ALPHA .33

```
MCP:FILT:ALPHA?
```

5.19.12 Noise Correction

Pressing **Noise Correction** turns noise correction **on** or **off**. When you set **Noise Correction** to **On**, a calibration of the noise floor is performed and used to correct for analyzer noise floor contribution to measurement levels, increasing dynamic range.

Key Path: **Meas Setup, More**

Key Notes: This key is not available when **Meas Setup, Method (RBW)** is selected or when signal tracking is on.

State Saved: Saved in instrument state.

Factory Preset: Off

History: Added with firmware revision A.02.00.

Remote Command:

```
[ :SENSe] :MCPower:CORRection:NOISe [:AUTO] OFF|ON|0|1
```

```
[ :SENSe] :MCPower:CORRection:NOISe [:AUTO] ?
```

Remote Command Notes: The noise correction feature is not available when the measurement method is **RBW (Meas Setup, Method (RBW))** or when signal tracking is on.

Example: MCP:CORR:NOIS 1

```
MCP:CORR:NOIS?
```

5.20 Trace/View (Multi-Carrier Power Measurement)

If **Multi-Carrier Power** has been selected in the **Measure** menu of the Spectrum Analysis mode, this key displays the appropriate **Trace/View** menu for the multi-carrier power measurement.

Displays menu keys that enable you to set how trace information is stored and displayed.

Key Path: Front-panel key

History: Added with firmware revision A.02.00

Remote Command:

There is no equivalent remote command for this function.

5.20.1 Spectrum

Pressing **Spectrum** selects the spectral display of the measurement.

Key Path: **Trace/View**

Factory Preset: Spectrum

History: Added with firmware revision A.02.00

Remote Command:

There is no remote command for this function.

5.20.2 Combined

Pressing **Combined** selects the measurement to be displayed as a bar graph and spectrum.

Key Path: **Trace/View**

Factory Preset: Spectrum

History: Added with firmware revision A.02.00

Remote Command:

There is no remote command for this function.

5.20.3 Combined View Units

Pressing **Combined View Units** selects the units (**dBc** or **dBm**) for the floating numeric displays when **Combined** is selected.

Key Path: **Trace/View**

Factory Preset: dBc

History: Added with firmware revision A.02.00

Remote Command:

There is no remote command for this function.

5.20.4 Trace

One-button measurements do not change this function. See [“Trace” on page 284](#) for more information.

5.20.4.1 Trace (1 2 3)

Determines which trace the menu keys will affect. Press **Trace 1 2 3** until the number of the desired trace is underlined.

Key Path: **Trace/View, Trace**

State Saved: Saved in Instrument State for all traces

History: Added with firmware revision A.02.00

Remote Command:

```
:TRACe [1] | 2 | 3 :MODE WRITe | MAXHold | MINHold | VIEW | BLANk
```

WRITe = **Clear Write**

MAXHold = **Max Hold**

MINHold = **Min Hold**

VIEW = **View**

BLANk = **Blank**

```
:TRACe [1] | 2 | 3 :MODE?
```

Example: TRAC:MODE WRIT
TRAC:MODE MAXH
TRAC:MODE MINH
TRAC:MODE VIEW
TRAC:MODE BLANk
TRAC:MODE?

5.20.4.2 Clear Write

See “Clear Write” on page 285 for more information.

5.20.4.3 Max Hold

See “Max Hold” on page 285 for more information.

5.20.4.4 Min Hold

See “Min Hold” on page 285 for more information.

5.20.4.5 View

See “View” on page 286 for more information.

5.20.4.6 Blank

See “Blank” on page 286 for more information.

5.21 Meas Setup (Occupied Bandwidth—OBW)

When **Occupied BW** has been selected in the **Measure** menu of the Spectrum Analysis Mode, this key displays the appropriate measurement setup menu.

The Occupied Bandwidth measurement integrates the power of the displayed spectrum and puts markers at the frequencies between which a selected percentage of the power is contained. The measurement defaults to 99% of the occupied bandwidth power. The power-bandwidth routine first computes the combined power of all signal responses contained in the trace. For 99% occupied power bandwidth, markers are placed at the frequencies on either side of 99% of the power. 1% of the power is evenly distributed outside the markers. The difference between the marker frequencies is the 99% power bandwidth and is the value displayed.

The occupied bandwidth function also indicates the difference between the analyzer center frequency and the center frequency of the channel, referred to as “Transmit Freq Error.” The measurement can be made in single or continuous sweep mode. The center frequency, reference level, and channel spacing must be set by the user.

Key Path: Front-panel key

5.21.1 Avg Number

Press **Avg Number (On)** to specify the number of measurement averages used when calculating the measurement result. The average is displayed at the end of each sweep. Press **Avg Number (Off)** to disable measurement averaging.

Key Path: **Meas Setup**

State Saved: Saved in instrument state.

Factory Preset: 10 averages / Off

Range: 1 through 1000

Remote Command:

```
[ :SENSE ] :OBW:AVERAge:COUNT <integer>
```

```
[ :SENSe ] :OBW:AVERAge:COUNT?
```

```
[ :SENSE ] :OBW:AVERAge [ :STATe ] OFF | ON | 0 | 1
```

```
[ :SENSe ] :OBW:AVERAge [ :STATe ] ?
```

Example: `OBW:AVER:COUN 20`

`OBW:AVER:COUN?`

OBW:AVER ON

OBW:AVER?

5.21.2 Avg Mode

Enables you to select the type of termination control used for the averaging function (**Exp** or **Repeat**). This determines the averaging action after the specified number of measurements (average count) is reached.

- **EXP** (Exponential Averaging mode)—Each successive data acquisition after the average count is reached is exponentially weighted and combined with the existing average. Exponential averaging weights new data more than old data, which facilitates tracking of slow-changing signals. The average is displayed at the end of each sweep.
- **Repeat**—After reaching the average count, all previous result data is cleared and the average count is set back to 1.

Key Path: **Meas Setup**

State Saved: Saved in instrument state.

Factory Preset: EXPonential

Remote Command:

```
[ :SENSe ] :OBW:AVERAge:TCONtrol EXPonential | REPeat
```

```
[ :SENSe ] :OBW:AVERAge:TCONtrol?
```

Example: OBW:AVG:TCON EXP

OBW:AVG:TCON?

5.21.3 Max Hold

Enables you to turn maximum hold trace feature **On** or **Off** for the measurement. Maximum hold displays and holds the maximum responses of a signal.

Key Path: **Meas Setup**

State Saved: Saved in instrument state.

Factory Preset: Off

Remote Command:

```
[ :SENSe ] :OBW:MAXHOld OFF | ON | 0 | 1
```

```
[ :SENSe ] :OBW:MAXHOld?
```

Example: OBW:MAXH ON

OBW:MAXH?

5.21.4 Occ BW % Pwr

Enables you to change the percentage of signal power used when determining the occupied bandwidth.

Key Path: **Meas Setup**

State Saved: Saved in instrument state.

Factory Preset: 99.0%

Range: 10.0% through 99.99%

Remote Command:

```
[ :SENSe ] :OBW:PERCent <percent>
```

```
[ :SENSe ] :OBW:PERCent?
```

Example: OBW:PERC 98

```
OBW:PERC?
```

5.21.5 OBW Span

Enables you to specify the range of integration used in calculating the total power from which the percent occupied bandwidth is then calculated. The analyzer span will be set to the same value as the OBW Span for the measurement. OBW Span should be set to approximately 2 times the expected occupied bandwidth result.

Key Path: **Meas Setup**

Factory Preset: 3 MHz, or as defined by the radio standard selected.

Default Terminator: Hz

Range:

Remote Command:

```
[ :SENSe ] :OBW:FREQuency:SPAN <freq>
```

```
[ :SENSe ] :OBW:FREQuency:SPAN?
```

Example: OBW:FREQ:SPAN 10 MHz

```
OBW:FREQ:SPAN?
```

5.21.6 x dB

Enables you to specify the power level used to determine the emission bandwidth as the number of dB down from the highest signal point (P_1), within the occupied bandwidth span. Frequencies f_1 and f_2 are determined as the furthest frequencies xdB below and above P_1 , respectively. The emission bandwidth is then calculated as $f_2 - f_1$ as shown in Figure 5-1.

NOTE The asterisk next to the x dB bandwidth value in Figure 5-1 indicates the results may not have been determined with optimal analyzer settings. If emission bandwidth is your primary interest, select **Meas Setup, Max Hold**. Then change detector mode to peak by pressing **Det/Demod, Detector, Peak**. Acquiring peak data ensures accuracy of this measurement.

Figure 5-1 Occupied Bandwidth Measurement Results

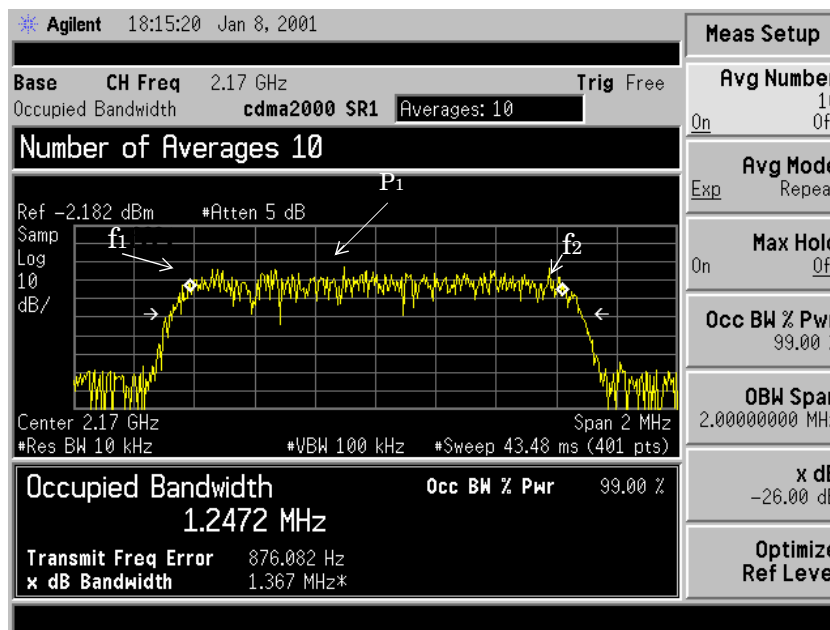

NOTE The “Transmit Freq Error” displayed above is defined as the difference between the $(f_2 + f_1)/2$ and the tuned center frequency of the signal.

- Key Path: **Meas Setup**
- State Saved: Saved in instrument state.
- Factory Preset: -26 dB
- Default Terminator: dB
- Range: -100.0 dB through -0.1 dB

One-Button Measurement Functions

Remote Command:

```
[ :SENSe ] :OBWidth :XDB <dB value>
```

```
[ :SENSe ] :OBWidth :XDB?
```

Example: OBW:XDB -50 dB

 OBW:XDB?

5.21.7 Optimize Ref Level

Sets the input attenuator to optimize the robustness of the measurement, which is its freedom from errors due to input compression.

NOTE There will always be a minimum of 6 dB of attenuation set to protect the analyzer input.

Key Path: **Meas Setup**

State Saved: Saved in instrument state.

Factory Preset: n/a

Remote Command:

```
[ :SENSe ] :POWer [ :RF ] :RANGe :AUTO ONCE
```

Example: POW:RANG:AUTO ONCE

5.22 Meas Setup (Spectrum Emissions Mask—SEM)

When the spectrum emissions mask measurement has been selected in the **Measure** menu of the Spectrum Analysis Mode, this key displays the appropriate measurement setup menu.

Spectrum Emissions Mask (SEM) measurement includes the in-band and out-of-band spurious emissions. As it applies to W-CDMA (3GPP), this is the power contained in a specified frequency bandwidth at certain offsets relative to the total carrier power. It may also be expressed as a ratio of power spectral densities between the carrier and the specified offset frequency band.

Key Path: Front-panel key
 History: Updated with firmware revision A.03.00
 Added with firmware revision A.02.00

5.22.1 Avg Number

Press **Avg Number (On)** to specify the number of measurement averages used when calculating the measurement result. The average will be displayed at the end of each sweep.

Key Path: **Meas Setup**
 State Saved: Saved in instrument state.
 Factory Preset: 10 averages / Off
 Range: 1 through 1000

Remote Command:

```
[ :SENSe] :SEMAsk:AVERAge:COUNT <integer>
[ :SENSe] :SEMAsk:AVERAge:COUNT?

[ :SENSe] :SEMAsk:AVERAge [:STATe] OFF|ON|0|1
[ :SENSe] :SEMAsk:AVERAge [:STATe] ?
```

Example: SEM:AVER:COUN 15
 SEM:AVER 1

5.22.2 Meas Type

Displays a menu where you can select a measurement reference type, **Total Pwr Ref** or **PSD Ref**.

Key Path: **Meas Setup**

Factory Preset: Total Pwr Ref

Remote Command:

```
[ :SENSE ] :SEMask:TYPE TPref | PSDRef
```

```
[ :SENSE ] :SEMask:TYPE?
```

Example: SEM:TYPE TPref or SEM:TYPE PSDRef
SEM:TYPE?

5.22.2.1 Total Pwr Ref

When **Total Pwr Ref** is selected, the power in the carrier is used as the reference in computing the relative power values for the offsets.

Key Path: **Meas Setup, Meas Type**

Readback: Reads back “Total Pwr Ref” to the **Meas Type** key.

History: Updated with firmware revision A.03.00

5.22.2.2 PSD Ref

When **PSD Ref** is selected, the mean power spectral density of the carrier is used in computing the relative power spectral density values for the offsets.

Key Path: **Meas Setup, Meas Type**

Readback: Reads back “PSD Ref” to the **Meas Type** key.

Factory Preset: On (Auto)

History: Updated with firmware revision A.03.00

5.22.3 Ref Channel

Accesses the menu of keys that enable you to change the reference channel settings.

Key Path: **Meas Setup**

5.22.3.1 Chan Integ BW

Specifies the integration bandwidth used in calculating the power in the main channel.

Key Path: **Meas Setup, Ref Channel**

Factory Preset: 3.84 MHz

Range: 10% to 100% of the setting of Chan Span

Remote Command:

```
[ :SENSE ] :SEMAsk :BANDwidth [n] | BWIDth [n] :INTEgration <number>
```

```
[ :SENSe ] :SEMAsk :BANDwidth [n] | BWIDth [n] :INTEgration?
```

Example: SEM:BAND [n] :INT 4 MHz

```
SEM:BWID [n] :INT 4 MHz
```

```
SEM:BAND [n] :INT?
```

```
SEM:BWID [n] :INT?
```

5.22.3.2 Chan Span

Specifies the span used in measuring the power in the main channel.

Key Path: **Meas Setup, Ref Channel**

Factory Preset: 5 MHz

Knob Increment: 1% of the set span.

Range: 1 kHz to 10 MHz

Remote Command:

```
[ :SENSe ] :SEMAsk :FREQuency :SPAN <number>
```

```
[ :SENSe ] :SEMAsk :FREQuency :SPAN?
```

Example: SEM:FREQ:SPAN 4 MHz

```
SEM:FREQ:SPAN?
```

5.22.3.3 Sweep Time

Specifies the sweep time used in measuring the power in the main channel.

Key Path: **Meas Setup, Ref Channel**

Factory Preset: Auto/On

Range: 1 ms through 2 ks

Remote Command:

```
[ :SENSe ] :SEMask:SWEeptime <number>  
[ :SENSe ] :SEMask:SWEeptime?  
[ :SENSe ] :SEMask:SWEeptime:AUTO OFF|ON|0|1  
[ :SENSe ] :SEMask:SWEeptime:AUTO?
```

Example: SEM:SWE 4 s
SEM:SWE?
SEM:SWE:AUTO 1
SEM:SWE:AUTO?

5.22.3.4 Res BW

Specifies the resolution bandwidth used in measuring and the power in the main channel.

Key Path: **Meas Setup, Ref Channel**

Factory Preset: 100 kHz/On

Range: Full Range provided by Base Instrument Hardware.

History: Remote command updated with firmware revision A.03.00

Remote Command:

```
[ :SENSe ] :SEMask:BANDwidth|BWIDth[:RESolution] <freq>  
[ :SENSe ] :SEMask:BANDwidth|BWIDth[:RESolution]?  
  
[ :SENSe ] :SEMask:BANDwidth|BWIDth[:RESolution]:AUTO OFF|ON|0|1  
[ :SENSe ] :SEMask:BANDwidth|BWIDth[:RESolution]:AUTO?
```

Remote Command Notes: If an unavailable bandwidth is entered, the closest available bandwidth is used. Refer to “Res BW” on page 83.

Example: SEM:BAND 4 MHz
SEM:BWID 4 MHz
SEM:BAND?
SEM:BWID?

SEM:BAND:AUTO 1
SEM:BWID:AUTO 1
SEM:BAND:AUTO?
SEM:BWID:AUTO?

5.22.3.5 Total Pwr Ref or PSD Ref

Displays the type of power measurement reference selected using the **Meas Type** key (see “Meas Type” on page 458).

Total Pwr Ref is the power in the carrier that is used as the reference in computing the relative power values for the offsets. When **Man** is selected, this can be set by the user. When **Auto** is selected, this is the measured power in the reference carrier.

PSD Ref is the mean power spectral density in the carrier that is used as the reference in computing the relative power spectral density values for the offsets. When **Man** is selected, this can be set by the user, when **Auto** is selected, this is the measured mean power spectral density in the reference carrier.

Key Path: **Meas Setup, Ref Channel**

Factory Preset: 0.00 dBm/Off

Range: –200.0 dBm to 200.0 dBm.

Remote Command:

[[:SENSe]:SEMAsk:CARRier[:POWER] <ampl>

[[:SENSe]:SEMAsk:CARRier[:POWER]?

[[:SENSe]:SEMAsk:CARRier:AUTO[:STATe] OFF|ON|0|1

[[:SENSe]:SEMAsk:CARRier:AUTO[:STATe]?

Example: SEM:CARR 0 dBm
 SEM:CARR?
 SEM:CARR:AUTO 1
 SEM:CARR:AUTO?

5.22.4 Offset/Limits

Displays the menus where you can change the following parameters for offset frequency settings and pass/fail tests: **Offset**, **Start Freq**, **Stop Freq**, **Sweep Time**, **Res BW**, and **Limits**. If **Spectrum Segment** is set to **Offset**. Refer to the tables below for default settings of particular radio standards of interest.

Table 5-2 Offsets & Limits Defaulted for W-CDMA (3GPP) Base Station Measurements^a

Offset	Start Freq (MHz)	Stop Freq (MHz)	ResBW (kHz)	Abs Start (dBm)	Abs Stop (dBm)	Abs Couple	Rel Start (dBc)	Rel Stop (dBc)	Meas BW
A, On	2.515	2.715	30.00	-14.00	-14.00	Couple	-30.00	-30.00	1
B, On	2.715	3.515	30.00	-14.00	-26.00	Man	-30.00	-30.00	1
C, On	3.515	4.000	30.00	-26.00	-26.00	Couple	-30.00	-30.00	1
D, On	4.000	8.000	1000.0	-13.00	-13.00	Couple	-30.00	-30.00	1
E, On	8.000	12.500	1000.0	-13.00	-13.00	Couple	-30.00	-30.00	1

a. **Fail Mask** is set to Absolute and **Rel Stop** is set to Couple.

Table 5-3 Offsets & Limits Defaulted for W-CDMA (3GPP) Mobile Station Measurements^a

Offset	Start Freq (MHz)	Stop Freq (MHz)	Res BW (kHz)	Abs Start (dBm)	Abs Stop (dBm)	Rel Start (dBc)	Rel Stop (dBc)	Rel Couple	Meas BW
A, On	2.515	3.485	30.00	-71.07	-71.07	-35.23	-49.78	Man	1
B, On	4.000	7.500	1000.0	-55.84	-55.84	-35.50	-39.00	Man	1
C, On	7.500	8.500	1000.0	-55.84	-55.84	-39.00	-49.00	Man	1
D, On	8.500	12.000	1000.0	-55.84	-55.84	-49.00	-49.00	Couple	1
E, Off	12.500	15.000	1000.0	-55.84	-55.84	-49.00	-49.00	Couple	1

a. **Abs Stop** is set to Couple and **Fail Mask** is set to Abs AND Rel.

Table 5-4 Offsets & Limits Defaulted for 802.11a and HiperLAN/2 Radio Standards^a

Offset	Start Freq (MHz)	Stop Freq (MHz)	Abs Start (dBm)	Abs Stop (dBm)	Abs Couple	Rel Start (dBc)	Rel Stop (dBc)	Rel Couple	Meas BW
A, On	9.00	11.00	16.00	-4.00	Man	0.00	-20.00	Man	1
B, On	11.00	20.00	-4.00	-12.00	Man	-20.00	-28.00	Man	1
C, On	20.00	30.00	-12.00	-24.00	Man	-28.00	-40.00	Man	1
D, On	30.00	50.00	-24.00	-24.00	Couple	-40.00	-40.00	Couple	1
E, Off	50.00	100.00	-24.00	-24.00	Couple	-40.00	-40.00	Couple	1

a. **Sweep Time** is set to 100 mseconds, **Res BW** is set to 100 kHz, and **Fail Mask** is set to Rel.

Table 5-5 Offsets & Limits Defaulted for 802.11b Radio Standard^a

Offset	Start Freq (MHz)	Stop Freq (MHz)	Abs Start (dBm)	Abs Stop (dBm)	Rel Start (dBc)	Rel Stop (dBc)	Meas BW
A, On	11.00	22.00	-10.00	-10.00	-30.00	-30.00	1
B, On	22.00	50.00	-30.00	-30.00	-50.00	-50.00	1
C, Off	50.00	70.00	-30.00	-30.00	-50.00	-50.00	1
D, Off	70.00	90.00	-30.00	-30.00	-50.00	-50.00	1
E, Off	90.00	100.00	-30.00	-30.00	-50.00	-50.00	1

a. **Sweep Time** is set to 100 mseconds, **Res BW** is set to 100 kHz, **Fail Mask** is set to Rel, and **Abs Stop** and **Rel Stop** are both set to Couple

5.22.4.1 Offset

Selects the offset pairs (upper and lower) that the menu keys affect, and displays the memory selection menu from **A** to **E** (where you can store up to 5 sets of values for **Start Freq**, **Stop Freq**, **Sweep Time**, **Res BW**, **Meas BW**, **Abs Start**, **Abs Stop**, and so forth). Press **Offset** until the letter of the desired offset (A, B, C, D, or E) is underlined. Only one selection at a time is shown on this key label.

Key Path: **Meas Setup, Offset/Limits**

State Saved: Saved in instrument state.

Factory Preset: A

Remote Command:

There is no remote command for this function.

5.22.4.2 Start Freq

Specifies the inner limit (frequency closest to the carrier) for both segments of the specified offset pair. When **Start Freq** (Off) is selected, the offset pair is not measured.

Key Path: **Meas Setup, Offset/Limits**

State Saved: Saved in instrument state.

Factory Preset: Dependent upon Radio Standard and device selected, refer to the default tables for “[Offset/Limits](#)” on page 462 for this value.

Default Terminator: Hz

Range: 0 Hz to the Stop Freq (for that offset) minus 10 Hz

Remote Command:

[:SENSe] :SEMAsk:OFFSet [n] :LIST:FREQuency:STARt <freq>, ... [<freq>] (up to five values)

[:SENSe] :SEMAsk:OFFSet [n] :LIST:FREQuency:STARt?

[:SENSe] :SEMAsk:OFFSet [n] :LIST:STATe OFF|ON|0|

[:SENSe] :SEMAsk:OFFSet [n] :LIST:STATe?

Remote Command Notes: Comma separated list of up to 5 values. n = 1 for BTS and n = 2 for MS. Default is BTS.

Offsets that are turned off, for the currently selected offset will return a -999.0 when queried.

Example: SEM:OFFS:LIST:FREQ:STAR 2 MHz

SEM:OFFS:LIST:FREQ:STAR?

```
SEM:OFFS:LIST:STAT 1  
SEM:OFFS:LIST:STAT?
```

5.22.4.3 Stop Freq

Specifies the outer limit (frequency furthest from the carrier) for both segments of the specified offset pair. The lower range is limited to the setting of **Start Freq**.

Key Path: **Meas Setup, Offset/Limits**

State Saved: Saved in instrument state.

Factory Preset: Dependent upon Radio Standard and device selected, refer to the default tables for “[Offset/Limits](#)” on page 462 for this value.

Default Terminator: Hz

Range: The Start Freq (for that offset) plus 10 Hz to 100 MHz

Remote Command:

```
[ :SENSe] :SEMAsk:OFFSet [n] :LIST:FREQuency:STOP <freq> ... [<freq>] (up to five values)
```

```
[ :SENSe] :SEMAsk:OFFSet [n] :LIST:FREQuency:STOP?
```

Remote Command Notes: Comma separated list of up to 5 values. n = 1 for BTS and n = 2 for MS. Default is BTS.

Example: SEM:OFFS:LIST:FREQ:STOP 4 MHz
SEM:OFFS:LIST:FREQ:STOP?

5.22.4.4 Sweep Time

Specifies the sweep time for the currently selected offset, and toggles this function between **Auto** and **Manual** for each offset.

Key Path: **Meas Setup, Offset/Limits**

State Saved: Saved in instrument state.

Factory Preset: Dependent upon Radio Standard and device selected, refer to the default tables for “[Offset/Limits](#)” on page 462 for this value.

Default Terminator: s (seconds)

Range: 1 ms to 2 ks

Remote Command:

```
[ :SENSe] :SEMAsk:OFFSet [n] :LIST:SWEeptime <time> ... [<time>] (up to five
```

values)

```
[ :SENSe ] :SEMAsk:OFFSet [n] :LIST:SWEeptime?
```

```
[ :SENSe ] :SEMAsk:OFFSet [n] :LIST:SWEeptime:AUTO OFF|ON|0|1
```

```
[ :SENSe ] :SEMAsk:OFFSet [n] :LIST:SWEeptime:AUTO?
```

Remote Command Notes: Comma separated list of up to 5 values. n = 1 for BTS and n = 2 for MS. Default is BTS.

Example: SEM:OFFS:LIST:SWE:AUTO 4 ms
SEM:OFFS:LIST:SWE:AUTO?
SEM:OFFS:LIST:SWE 4 ms
SEM:OFFS:LIST:SWE?

5.22.4.5 Res BW

Specifies the resolution bandwidth used in measuring the offset pair. When set to Auto, the Res BW from the default tables for “Offset/Limits” on page 462 are used. When set to Man, the range of settings is the range of the available Res BW of the analyzer, except the maximum is further limited to not exceed (Stop Freq - Start Freq).

Key Path: **Meas Setup, Offset/Limits**

State Saved: Saved in instrument state.

Factory Preset: Dependent upon Radio Standard and device selected, refer to the default tables for “Offset/Limits” on page 462 for this value.

Default Terminator: Hz

Remote Command:

```
[ :SENSe ] :SEMAsk:OFFSet [n] :LIST:BANDwidth|BWIDth[:RESolution]  
<freq>... [<freq>] (up to five values)
```

```
[ :SENSe ] :SEMAsk:OFFSet [n] :LIST:BANDwidth|BWIDth[:RESolution] ?
```

```
[ :SENSe ] :SEMAsk:OFFSet [n] :LIST:BANDwidth|BWIDth[:RESolution] :AUTO  
OFF|ON|0|1
```

```
[ :SENSe ] :SEMAsk:OFFSet [n] :LIST:BANDwidth|BWIDth[:RESolution] :AUTO?
```

Remote Command Notes: Comma separated list of up to 5 values. n = 1 for BTS and n = 2 for MS. Default is BTS (1).

You may only enter valid Res BW filter frequencies. Refer to “Res BW” on page 83.

Example:

SEM:OFFS:LIST:BAND 40 kHz or SEM:OFFS:LIST:BWID 40 kHz

SEM:OFFS:LIST:BAND? or SEM:OFFS:LIST:BWID?

SEM:OFFS:LIST:BAND:AUTO 0 or SEM:OFFS:LIST:BWID:AUTO 0

SEM:OFFS:LIST:BAND:AUTO? or SEM:OFFS:LIST:BWID:AUTO?

5.22.4.6 Meas BW

Enables you to specify the bandwidth to use when measuring the offset. When using the front panel, only the currently selected offset is affected. All the offsets are affected when using the remote command. This is the multiplier applied to the resolution bandwidth to determine the bandwidth to integrate when calculating the power.

Key Path: **Meas Setup, Offset/Limits**

Key Notes: When setting Meas BW > 1, dynamic range is increased, however measurement time is also increased since an increased number of sweep points are required to make the measurement. For Meas BW > 1, consider this equation for trace points:

$$\text{Trace points} = (\text{Offset Stop Freq} - \text{Offset Start Freq}) / (\text{Meas BW}/100)$$

When Meas BW = 1, the number of trace points are set at the value specified upon entering the measurement.

Dependencies/

Couplings: This parameter must adhere to the rule: $(N \times \text{Res BW}) \leq (\text{Stop Freq of the offset} - \text{Start freq of the offset})$, where N is Meas BW value. If the Res BW is changed, Meas BW will change to ensure this rule.

n/a

State Saved: Saved in instrument state.

Factory Preset: 1

Default Terminator: x Res BW

Knob Increment: 1

Step Key

Increment: 1

Range: 1 to 1000

History: Added with firmware revision A.02.00

Remote Command:

```
[ :SENSe ] :SEMask:OFFSet [n] :LIST:BANDwidth|BWIDth:IMULti <integer>
```

```
[ :SENSe ] :SEMask:OFFSet [n] :LIST:BANDwidth|BWIDth:IMULti?
```

```
[ :SENSe ] :SEMask:OFFSet [n] :LIST:BANDwidth|BWIDth[:RESolution] :AUTO  
OFF|ON|0|1
```

```
[ :SENSe ] :SEMask:OFFSet [n] :LIST:BANDwidth|BWIDth[:RESolution] :AUTO?
```

Remote Command Notes: Comma separated list of up to 5 values. n = 1 for BTS and n = 2 for MS. Default is BTS (1).

Example: SEM:OFFS:LIST:BAND:IMUL 40 or SEM:OFFS:LIST:BWID:IMUL 40

SEM:OFFS:LIST:BAND:IMUL? or SEM:OFFS:LIST:BWID:IMUL?

SEM:OFFS:LIST:BAND:AUTO 0 or SEM:OFFS:LIST:BWID:AUTO 0

SEM:OFFS:LIST:BAND:AUTO? or SEM:OFFS:LIST:BWID:AUTO?

5.22.4.7 Abs Start

Enables you to enter an absolute level limit at **Start Freq** for the currently selected offset ranging from –200.00 to +50.00 dBm with 0.01 dB resolution.

Key Path: **Meas Setup, Offset/Limits**

State Saved: Saved in instrument state.

Factory Preset: Dependent upon Radio Standard and device selected, refer to the default tables for “[Offset/Limits](#)” on page 462 for this value.

Default Terminator: dBm

Range: –200 dBm to 50 dBm

Remote Command:

[[:SENSE]:SEMMask:OFFSet [n]:LIST:STARt:ABSolute <ampl>, ... [<ampl>] (up to five values)

[[:SENSE]:SEMMask:OFFSet [n]:LIST:STARt:ABSolute?

Remote Command Notes: Comma separated list of up to 5 values. n = 1 for BTS and n = 2 for MS. Default is BTS (1).

Example: SEM:OFFS:LIST:STAR:ABS -20 dBm
SEM:OFFS:LIST:STAR:ABS

5.22.4.8 Abs Stop

Enables you to enter an absolute level limit at **Stop Freq** for the currently selected offset ranging from –200.00 to +50.00 dBm with 0.01 dB resolution, and to toggle this function between **Couple** and **Man**. If set to **Couple**, this is coupled to **Abs Start** to make a flat limit line. If set to **Man**, **Abs Start** and **Abs Stop** you can enter different values to make a sloped limit line.

Key Path: **Meas Setup, Offset/Limits**

State Saved: Saved in instrument state.

Factory Preset: Dependent upon Radio Standard and device selected, refer to the default tables for “[Offset/Limits](#)” on page 462 for this value.

Default Terminator: dBm

One-Button Measurement Functions
Meas Setup (Spectrum Emissions Mask—SEM)

Range: –200 dBm to 50 dBm

Remote Command:

[:SENSE] :SEMAsk:OFFSet [n] :LIST:STOP:ABSolute <ampl>, ... [<ampl>] (up to five values)

[:SENSE] :SEMAsk:OFFSet [n] :LIST:STOP:ABSolute?

[:SENSE] :SEMAsk:OFFSet [n] :LIST:STOP:ABSolute:COUPle OFF|ON|0|1

[:SENSE] :SEMAsk:OFFSet [n] :LIST:STOP:ABSolute:COUPle?

Remote Command Notes: Comma separated list of up to 5 values. n = 1 for BTS and n = 2 for MS. Default is BTS (1).

Example: SEM:OFFS:LIST:STOP:ABS -20 dBm
SEM:OFFS:LIST:STOP:ABS

SEM:OFFS:LIST:STOP:ABS:COUP 0

SEM:OFFS:LIST:STOP:ABS:COUP?

5.22.4.9 Rel Start

Enables you to enter a relative level limit at **Start Freq** ranging from -150.00 to +50.00 dBc with 0.01 dB resolution.

Key Path: **Meas Setup, Offset/Limits, More**

State Saved: Saved in instrument state.

Factory Preset: Dependent upon Radio Standard and device selected, refer to the default tables for “[Offset/Limits](#)” on page 462 for this value.

Default Terminator: dBc

Range: -200 dBc to 50 dBc

Remote Command:

[[:SENSE]:SEMASK:OFFSet [n]:LIST:STARt:RCARrier <rel_ampl>,... [<rel_ampl>]
(up to five values)

[[:SENSE]:SEMASK:OFFSet [n]:LIST:STARt:RCARrier?

Remote Command Notes: Comma separated list of 5 values. n = 1 for BTS and n = 2 for MS. Default is BTS (1).

Example: SEM:OFFS:LIST:STAR:RCAR -20 dBc
SEM:OFFS:LIST:STAR:RCAR

5.22.4.10 Rel Stop

Enables you to enter a relative level limit at **Stop Freq** ranging from -150.00 to +50.00 dBc with 0.01 dB resolution, and to toggle this function between **Couple** and **Man**. If set to **Couple**, this is coupled to **Rel Start** to make a flat limit line. If set to **Man**, **Rel Start** and **Rel Stop** you can enter different values to make a sloped limit line.

Key Path: **Meas Setup, Offset/Limits, More**

State Saved: Saved in instrument state.

Factory Preset: Dependent upon Radio Standard and device selected, refer to the default tables for “[Offset/Limits](#)” on page 462 for this value.

Default Terminator: dBc

Range: -200 dBc to 50 dBc

Remote Command:

```
[ :SENSE ] :SEMAsk:OFFSet [n] :LIST:STOP:RCARrier <real number>, [<real number>] ...
```

```
[ :SENSE ] :SEMAsk:OFFSet [n] :LIST:STOP:RCARrier?
```

```
[ :SENSE ] :SEMAsk:OFFSet [n] :LIST:STOP:RCARrier:COUPle OFF|ON|0|1
```

```
[ :SENSE ] :SEMAsk:OFFSet [n] :LIST:STOP:RCARrier:COUPle?
```

Remote Command Notes: Comma separated list of 5 values. n = 1 for BTS and n = 2 for MS. Default is BTS (1).

Example: SEM:OFFS:LIST:STOP:RCAR -20 dBm

```
SEM:OFFS:LIST:STOP:RCAR
```

```
SEM:OFFS:LIST:STOP:RCAR:COUP 0
```

```
SEM:OFFS:LIST:STOP:RCAR:COUP?
```

5.22.4.11 Fail Mask

Displays the menu to select one of the following logic keys for fail conditions between the measurement results and the test limits: **Absolute**, **Relative**, **Abs AND Rel**, and **Abs OR Rel**.

Absolute - Fail is shown if one of the absolute spectrum emission mask measurement results is larger than the limit between **Abs Start** and **Abs Stop**, inclusive. This is the default selection for each offset for BTS measurements.

Relative - Fail is shown if one of the relative spectrum emission mask measurement results is larger than the limit between **Rel Start** and **Rel Stop**, inclusive.

Abs AND Rel - Fail is shown if one of the absolute spectrum emission mask measurement results is larger than the limit between **Abs Start** and **Abs Stop**, inclusive AND one of the relative spectrum emission mask measurement results is larger than the limit for **Rel Start** and **Rel Stop**. This is the default for MS measurements.

Abs OR Rel - Fail is shown if one of the absolute spectrum emission mask measurement results is larger than the limit between **Abs Start** and **Abs Stop**, inclusive OR one of the relative spectrum emission mask measurement results is larger than the limit for **Rel Start** and **Rel Stop**.

Key Path: Meas Setup, Offset/Limits, More

State Saved: Saved in instrument state.

Factory Preset: Dependent upon Radio Standard and device selected, refer to the default

tables for “Offset/Limits” on page 462 for this value.

Remote Command:

```
[[:SENSE]:SEMAsk:OFFSet [n]:LIST:TEST  
ABSolute|AND|OR|RELative,ABSolute|AND|OR|RELative,ABSolute|AND|OR|RELative  
,ABSolute|AND|OR|RELative
```

```
[[:SENSE]:SEMAsk:OFFSet [n]:LIST:TEST?
```

Remote Command Notes: Comma separated list of 5 values. n = 1 for BTS and n = 2 for MS. Default is BTS (1).

Example: SEM:OFFS:LIST:TEST ABS,REL,ABS AND REL,ABS OR REL
SEM:OFFS:LIST:TEST?

5.22.4.11.1 Absolute

Set the limit test to show Fail if one of the absolute spectrum emission mask measurement results is larger than the limit for **Abs Start** and/or **Abs Stop**. This is the default selection for each offset

Key Path: Meas Setup, Offset/Limits, More, Fail Mask

State Saved: Saved in instrument state.

Factory Preset: Dependent upon Radio Standard and device selected, refer to the default tables for “Offset/Limits” on page 462 for this value.

Remote Command:

Refer to “Fail Mask” on page 472.

5.22.4.11.2 Relative

Sets the limit test to show Fail if one of the relative spectrum emission mask measurement results is larger than the limit for **Rel Start** and/or **Rel Stop**.

Key Path: Meas Setup, Offset/Limits, More, Fail Mask

State Saved: Saved in instrument state.

Factory Preset: Dependent upon Radio Standard and device selected, refer to the default tables for “Offset/Limits” on page 462 for this value.

Remote Command:

Refer to “Fail Mask” on page 472.

5.22.4.11.3 Abs AND Rel

Set the limit test to show Fail if one of the absolute spectrum emission mask measurement results is larger than the limit for **Abs Start** and **Abs Stop** AND one of the relative spectrum emission mask measurement results is larger than the limit for **Rel Start** and **Rel Stop**.

Key Path: **Meas Setup, Offset/Limits, More, Fail Mask**

State Saved: Saved in instrument state.

Factory Preset: Dependent upon Radio Standard and device selected, refer to the default tables for “Offset/Limits” on page 462 for this value.

Remote Command:

Refer to “Fail Mask” on page 472.

5.22.4.11.4 Abs OR Rel

Set the limit test to show Fail if one of the absolute spectrum emission mask measurement results is larger than the limit for **Abs Start** and **Abs Stop** OR one of the relative spectrum emission mask measurement results is larger than the limit for **Rel Start** and **Rel Stop**.

Key Path: **Meas Setup, Offset/Limits, More, Fail Mask**

State Saved: Saved in instrument state.

Factory Preset: Dependent upon Radio Standard and device selected, refer to the default tables for “Offset/Limits” on page 462 for this value.

Remote Command:

Refer to “Fail Mask” on page 472.

5.22.5 Optimize Ref Level

Sets the input attenuator to optimize the robustness of the measurement, which is its freedom from errors due to input compression.

NOTE There is always a minimum of 6 dB of attenuation set to protect the analyzer input.

Key Path: **Meas Setup**

State Saved: Saved in instrument state.

Remote Command:

```
[ :SENSE ] :POWER [ :RF ] :RANGE :AUTO ONCE
```

Example: POW:RANG:AUTO ONCE

5.22.6 RRC Filter

Pressing **RRC Filter** turns the Root Raised Cosine filter on or off. This filter is the type

specified in the 3GPP W-CDMA standards. This parameter is only available when **3GPP W-CDMA** is selected as the **Radio Std** from the **Mode Setup** menu. If **3GPP W-CDMA** is selected, the roll-off value (alpha) for the filter will be initially set to 0.22 and T will be 260 ns. The roll-off value can be changed using **Filter Alpha**.

Key Path: **Meas Setup**

State Saved: Saved in instrument state.

Factory Preset: Off

History: Added with firmware revision A.03.00.

Remote Command:

```
[ :SENSe] :SEMAsk:FILTeR [ :RRC] [ :STATe] OFF|ON|0|1
```

```
[ :SENSe] :SEMAsk:FILTeR [ :RRC] [ :STATe] ?
```

Example: SEM:FILT 1

SEM:FILT?

5.22.7 Filter Alpha

Press **RRC Filter** to input the alpha value for the RRC Filter. This parameter is only available when **3GPP W-CDMA** is selected as the Radio Std. from the Mode Setup menu.

Key Path: **Meas Setup**

State Saved: Saved in instrument state.

Factory Preset: 0.22 when W-CDMA is selected, otherwise Off.

Knob Increment: 0.01

Step Key

Increment: 0.1

Range: 0.01 to 1.0

History: Added with firmware revision A.03.00.

Remote Command:

```
[ :SENSe] :SEMAsk:FILTeR [ :RRC] :ALPHA <number>
```

```
[ :SENSe] :SEMAsk:FILTeR [ :RRC] :ALPHA?
```

5.23 Trace/View (Spectrum Emissions Mask)

If **Spectrum Emission Mask** has been selected in the **Measure** menu of the Spectrum Analysis mode, this key displays the appropriate **Trace/View** menu for the spectrum emission mask (SEM).

Displays menu keys that enable you to set how trace information is stored and displayed.

Key Path: Front-panel key

History: Added with firmware revision A.02.00

Remote Command:

There is no remote command for this function.

5.23.1 Abs Pwr & Freq

Press **Abs Pwr & Freq** to view the measurement results of Spectrum (Ref: Total Pwr, Seg: Offset) measurements in the graph window as absolute peak power and frequency. The absolute peak power levels, in dBm and those corresponding offset frequency ranges on both sides of the reference channel are displayed in the text window.

Key Path: **Trace/View**

Saved State: Saved in instrument state.

Factory Preset: On

Remote Command:

There is no remote command for this function.

5.23.2 Rel Pwr & Freq

Press **Rel Pwr & Freq** to view the measurement results of Spectrum (Ref: Total Pwr, Seg: Offset) measurements in the graph window as power relative to the carrier power and frequency. The relative power levels in dBc and those corresponding offset frequency ranges on both sides of the reference channel are displayed in the text window.

Key Path: **Trace/View**

Saved State: Saved in instrument state.

Remote Command:

There is no remote command for this function.

5.23.3 Integrated Power

Press **Integrated Power** to view the measurement results of Spectrum (Ref: Total Pwr, Seg: Offset) measurements in the graph window as integrated absolute and relative peak power and frequency. The absolute and relative peak power levels integrated throughout the bandwidths between the start and stop frequencies and those corresponding offset frequency ranges on both sides of the reference channel are displayed in the text window.

Key Path: **Trace/View**

Saved State: Saved in instrument state.

Remote Command:

There is no remote command for this function.

5.24 Display (Spectrum Emissions Mask—SEM)

Displays menu keys that enable you to configure parameters for the CCDF measurement.

NOTE The keys described below are measurement dependent. To access the display menus, for the SEM measurement press **Measure**, **Spectrum Emission Mask**, then **Display**.

5.24.1 Full Screen

Expands the measurement window horizontally over the entire instrument display. Pressing any other key that results in a new menu cancels the full screen function.

Key Path: Display
Key Path: Display
State Saved: Not saved in state.
Factory Preset: Off
Factory Default: Off
History: Added with firmware revision A.02.00

5.24.2 Limit Display

Allows you to toggle the limit lines display function for spectrum emission mask measurements between **On** and **Off**. If set to **On**, the absolute limit lines and the relative limit lines are shown on the spectrum emission mask measurement display.

Key Path: Display, Limit Display
State Saved: Saved in instrument state.
Factory Preset: On
History: Added with firmware revision A.02.00

5.24.3 Preferences

Displays menu keys that enable you to turn the graticule and annotation on or off.

Key Path: Display
State Saved: Saved in instrument state.

History: Added with firmware revision A.02.00

5.24.3.1 Graticule (On Off)

Pressing Graticule turns the display graticules **On** or **Off**.

Key Path: **Display, Preferences**

Factory Preset: On

Factory
Default: On

Terminators: **Enter**

History: Added with firmware revision A.02.00

5.24.3.2 Annotation (On Off)

Turns the screen annotation on or off, however, menu key annotation will remain on the display. The screen annotation may not be required for prints or during remote operation.

Key Path: **Display**

Factory Preset
and *RST: On

Factory
Default: On

Terminators: **Enter**

History: Added with firmware revision A.02.00

5.25 SPAN X Scale (Spectrum Emissions Mask—SEM)

Activates the Span function for the SEM measurement and displays the menu of span functions.

Key Path: Front-panel key
 State Saved: Saved in Instrument State

Remote Command:

See the [Scale/Div](#), [Ref Value](#), and [Ref Position](#) commands below.

5.25.1 Scale/Div

Allows you to enter a numeric value to change the horizontal display sensitivity by setting the frequency units per horizontal graticule division. To determine full display frequency span, multiply the frequency span per horizontal graticule division by 10. This function is only available when you select **Spectrum Emissions Mask** from the Measurement menu.

Key Path: **MEASURE, Spectrum Emission Mask, SPAN X Scale**
 State Saved: Saved in Instrument State
 Factory Preset: 2.50000000 MHz
 History: Added with firmware revision A.02.00

5.25.2 Ref Value

Press **Ref Value** to set the frequency represented by the selected horizontal graticule line on the display (the reference). The current value is indicated by `Ref Value` in the upper left corner of the display. You can change the reference value using the step keys, the knob, or the numeric keypad. You can set the reference line location using the **Ref Position** setting. This function is only available when you select **Spectrum Emissions Mask** from the Measurement menu.

Key Path: **MEASURE, Spectrum Emission Mask, SPAN X Scale**
 State Saved: Saved in Instrument State
 Factory Preset: Center frequency value in Factory Preset state.
 History: Added with firmware revision A.02.00

5.25.3 Ref Position

Press **Ref Position** to position the X-Scale reference to the extreme left line, center line, or

One-Button Measurement Functions
SPAN X Scale (Spectrum Emissions Mask—SEM)

extreme right line of the display graticule.

Key Path: **MEASURE, Spectrum Emission Mask, SPAN X Scale**

Factory Preset: Center

5.26 Marker (Spectrum Emissions Mask—SEM)

Displays the Marker control menu for the SEM measurement. If no markers are active, **Marker** selects marker 1, sets it to **Normal** and places it to the right of the display. There are two control modes for the markers:

- **Normal (POSITION)** - A single marker that can be moved to any point on the trace.
- **Off (OFF)** - Turns off the active marker or marker pair.

Key Path: Front-panel key

State Saved: The control mode for each marker, as well as the position of each marker, is saved in instrument state.

Factory Preset: All Off.

Remote Command:

There is no equivalent remote command.

5.26.1 Select Marker

Selects one of the four possible markers. Once a marker is selected, it can be set to any of the control modes **Normal** or **Off**.

Key Path: **Marker**

State Saved: The number of the selected marker is saved in instrument state.

Factory Preset: Marker 1

History: Remote command updated with firmware revision A.03.00

Remote Command:

```
:CALCulate:SEMask:MARKer [1] | 2 | 3 | 4:STATe OFF|ON|0|1
```

```
:CALCulate:SEMask:MARKer [1] | 2 | 3 | 4:STATe?
```

Remote Command Notes: Sets or queries the state of a marker. Setting a marker to state ON or 1 selects that marker. Setting a marker which is OFF to state ON or 1 puts it in **Normal** mode and places it on the screen to the right of the displayed measurement graph. Setting a marker to state OFF or 0 selects that marker and turns it off. The response to the query will be 0 if OFF, 1 if ON.

Example: CALC:SEM:MARK2:STAT ON selects marker 2.

CALC:SEM:MARK:STAT ON will not modify a marker that is already on.

5.26.2 Normal

Sets the control mode for the selected marker to **Normal** (see “[Select Marker](#)” on page 483). If the marker is off, a single marker is activated and placed on the screen to the right of the measurement graph. You can then adjust the trace point of the marker using the knob, numeric keypad, or \uparrow \downarrow keys.

Key Path: **Marker**

Factory Preset: Off

History: Remote command updated with firmware revision A.03.00

Remote Command:

See “[Marker \(Spectrum Emissions Mask—SEM\)](#)” on page 483 for the mode command.

Example: `CALC:SEM:MARK:STAT ON` selects marker 1 and sets it to **Normal**.

5.26.3 Off

Turns off the selected marker. In addition, **Off** also turns off functions related to the selected marker.

Key Path: **Marker**

Factory Preset: Off

History: Remote command updated with firmware revision A.03.00

Remote Command:

See “[Select Marker](#)” on page 483 for the command to select the control mode.

Example: `CALC:SEM:MARK3:STAT OFF` selects marker 3 and sets it to **Off**.

5.27 Meas Setup (Spurious Emissions)

When the spurious emissions measurement has been selected in the **Measure** menu of the Spectrum Analysis mode, this key displays the appropriate measurement setup menu.

The spurious emissions measurement identifies and determines the power level of spurious emissions in certain frequency bands.

Key Path: Front-panel key

History: Added with firmware revision A.02.00

Remote Command:

There is no equivalent remote command.

5.27.1 Avg Number

Press **Avg Number** to **On** to specify the number of measurements that will be averaged when calculating the measurement result. The average will be displayed at the end of each sweep. **Off** disables the measurement averaging.

Key Path: **Meas Setup**

State Saved: Saved in instrument state.

Factory Preset: 10 averages / Off

Range: 1 to 1000

Remote Command:

```
[ :SENSE ] : SPURious : AVERage : COUNT <integer>
```

```
[ :SENSE ] : SPURious : AVERage : COUNT ?
```

```
[ :SENSE ] : SPURious : AVERage [ :STATE ] OFF | ON | 0 | 1 turns the averaging on or off.
```

```
[ :SENSE ] : SPURious : AVERage [ :STATE ] ?
```

Example: SPUR:AVER:COUN 10

SPUR:AVER OFF

5.27.2 Avg Mode

Selects the type of termination control used for the averaging function (Exp or Repeat). This determines the averaging action after the specified number of measurements (average count) is reached.

- **EXP** (Exponential Averaging mode)—When you set **Avg Mode** to **Exp**, each successive data acquisition after the average count is reached is exponentially weighted and combined with the existing average. Exponential averaging weights new data more than old data, which facilitates tracking of slow-changing signals. The average will be displayed at the end of each sweep.
- **Repeat**—When you set **Avg Mode** to **Repeat**, after reaching the average count, all previous result data is cleared and the average count is set back to 1.

Key Path: **Meas Setup**

State Saved: Saved in instrument state.

Factory Preset: EXPOnential

Range: EXPOnential | REPeat

Remote Command:

```
[ :SENSE ] :SPURious :AVERage :TCONrol EXPOnential | REPeat
```

```
[ :SENSE ] :SPURious :AVERage :TCONrol ?
```

Example: SPUR:AVG:TCON EXP
SPUR:AVG:TCON?

5.27.3 Range Table

Enables you to enter the settings for up to 20 ranges, either using the instrument front panel keys or remotely. Upon entering the range table, the measurement stops, then the analyzer is set to a constantly sweeping idle state. The analyzer is then set to the current values for range 1 (whether range 1 is on or off). If a range is currently off, the values in the range table for that range are replaced with --- (see Range 5 in the illustration) to

indicate this range is currently inactive.

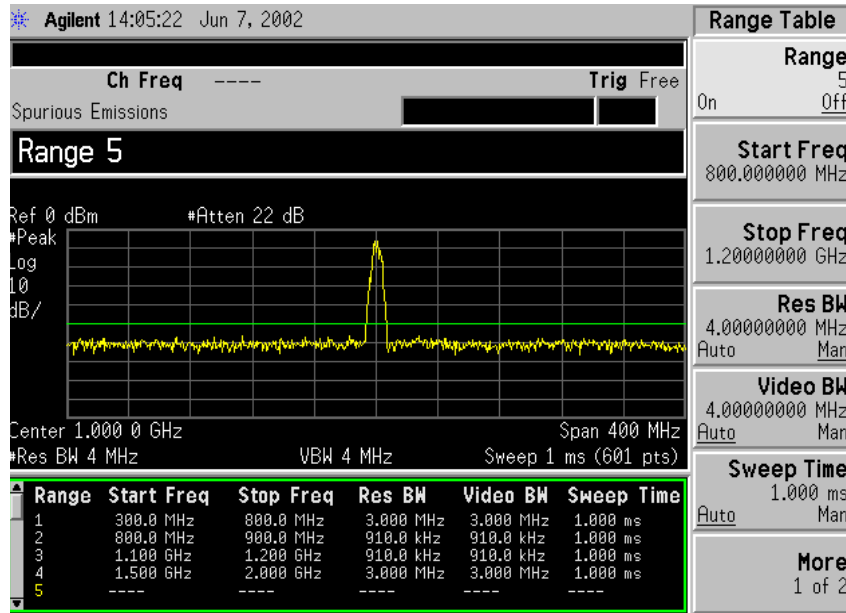

Key Path: **Meas Setup**

Saved State: All values for all ranges are saved in instrument state.

Factory Preset: For each range, the following settings are selected: **Video BW (Auto)**, **Sweep Time (Auto)**, **Absolute Limit = -50 dBm**, **Peak Threshold = -90 dBm**, **Peak Excursion = 6 dB**, and **Abs Stop Limit Mode (Auto)** is set to -50 dBm. The table below defines the other parameter's settings for the measurement. The values for ranges 1 through 5 are based on the W-CDMA (3GPP) BTS Spurious Emission measurement.

Table 5-6 Range Table Default Settings

Range	Start Freq (GHz)	Stop Freq (GHz)	Res BW (kHz)
1	1.920	1.980	1200
2	1.894	1.920	510
3	2.100	2.102	100
4	2.175	2.180	100
5	0.800	1.000	4000
6-20	1.5	2.5	Auto

Remote Command:

There is no equivalent remote command.

5.27.3.1 Range

Selects a range and updates the values on the other **Range Table** keys so that they reflect the settings for the selected range. If **Range** is set to **On** it is used as part of the measurement; when set to **Off** it is excluded.

Key Path: **Meas Setup, Range Table**

Factory Preset: See “[Range Table](#)” on page 486.

Range: Off|On

Remote Command:

This parameter can receive up to 20 values. The location in the list sent corresponds to the range the value is associated with. Missing values are not permitted. For example, if you want to change values 2 and 6, you must send all values up to 6. Subsequent values remain as they were.

```
[ :SENSE ] :SPURious [ :RANGe ] [ :LIST ] :STATe OFF|ON|0|1
```

The query for this parameter will always return 20 values.

```
[ :SENSE ] :SPURious [ :RANGe ] [ :LIST ] :STATe?
```

Example: SPUR:STAT OFF,ON,ON,OFF,ON,ON
lists values 1 through 6

5.27.3.2 Start Freq

Used to set the start frequency of the analyzer.

Key Path: **Meas Setup, Range Table**

Factory Preset: See “[Range Table](#)” on page 486.

Knob Increment: 1%

Step Key

Increment: 1, 1.5, 2, 3, 5, 7.5, 10, ...

Range: Frequency range of your analyzer.

Remote Command:

This parameter can receive up to 20 values. The location in the list sent corresponds to the range the value is associated with. Missing values are not permitted, for example, if you want to change values 2 and 6, you must send all values up to 6. Subsequent values will remain as they were.

```
[ :SENSE ] :SPURious [ :RANGe ] [ :LIST ] :FREQuency:START <integer>
```

The query for this parameter will always return 20 values.

```
[ :SENSe ] :SPURious [ :RANGe ] [ :LIST ] :FREQuency :START?
```

5.27.3.3 Stop Freq

Stop Freq is used to set the stop frequency of the analyzer.

Key Path: **Meas Setup, Range Table**

Factory Preset: See “Range Table” on page 486.

Knob Increment: 1%

Step Key

Increment: 1, 1.5, 2, 3, 5, 7.5, 10, ...

Range: Frequency range of your analyzer.

Remote Command:

This parameter can receive up to 20 values. The location in the list sent corresponds to the range the value is associated with. Missing values are not permitted, for example, if you want to change values 2 and 6, you must send all values up to 6. Subsequent values will remain as they were.

```
[ :SENSE ] :SPURious [ :RANGe ] [ :LIST ] :FREQuency:STOP <integer>
```

The query for this parameter will always return 20 values.

```
[ :SENSE ] :SPURious [ :RANGe ] [ :LIST ] :FREQuency:STOP?
```

5.27.3.4 Res BW

Res BW is used to set the resolution bandwidth of the analyzer. When **Auto** is selected the analyzer determines the optimum setting, while **Man** enables you to determine the setting.

Key Path: **Meas Setup, Range Table**

Factory Preset: See “Range Table” on page 486.

Knob Increment: Steps through the available resolution bandwidth filters.

Step Key

Increment: Steps through the available resolution bandwidth filters.

Range: Resolution bandwidth range of your analyzer.

Remote Command:

This parameter can receive up to 20 values. The location in the list sent corresponds to the range the value is associated with. Missing values are not permitted, for example, if you want to change values 2 and 6, you must send all values up to 6. Subsequent values will remain as they were.

```
[ :SENSE ] :SPURious [ :RANGe ] [ :LIST ] :BANDwidth [ :RESolution ] :AUTO OFF|ON|0|1  
selects the mode.
```

```
[ :SENSE ] :SPURious [ :RANGe ] [ :LIST ] :BANDwidth [ :RESolution ] <integer>
```

The query for this parameter always returns 20 values.

```
[ :SENSe ] :SPURious [ :RANGe ] [ :LIST ] :BANDwidth [ :RESolution ] :AUTO?
[ :SENSe ] :SPURious [ :RANGe ] [ :LIST ] :BANDwidth [ :RESolution ] ?
```

5.27.3.5 Video BW

Video BW is used to set the video bandwidth of the analyzer. When **Auto** is selected the analyzer determines the optimum setting, while **Man** enables you to determine the setting.

Key Path: **Meas Setup, Range Table**

Factory Preset: See “Range Table” on page 486.

Knob Increment: Steps through the available video bandwidth filters.

Step Key

Increment: Steps through the available video bandwidth filters.

Range: Video bandwidth range of your analyzer.

Remote Command:

This parameter can receive up to 20 values. The location in the list sent corresponds to the range the value is associated with. Missing values are not permitted, for example, if you want to change values 2 and 6, you must send all values up to 6. Subsequent values will remain as they were.

```
[ :SENSe ] :SPURious [ :RANGe ] [ :LIST ] :BWIDth | BANDwidth :VIDeo :AUTO OFF | ON | 0 | 1
selects the mode.
```

```
[ :SENSe ] :SPURious [ :RANGe ] [ :LIST ] :BWIDth | BANDwidth :VIDeo <integer>
```

The query for this parameter will always return 20 values.

```
[ :SENSe ] :SPURious [ :RANGe ] [ :LIST ] :BWIDth | BANDwidth :VIDeo :AUTO?
```

```
[ :SENSe ] :SPURious [ :RANGe ] [ :LIST ] :BWIDth | BANDwidth :VIDeo?
```

5.27.3.6 Sweep Time

Sweep Time is used to set the sweep time of the analyzer. When **Auto** is selected the analyzer determines the optimum setting, while **Man** enables you to determine the setting.

Key Path: **Meas Setup, Range Table**

Factory Preset: See “Range Table” on page 486.

Knob Increment: 1%

Step Key

Increment: 1, 1.5, 2, 3, 5, 7.5, 10, ...

Range: Sweep time range of your analyzer.

Remote Command:

```
[ :SENSe ] :SPURious [ :RANGe ] [ :LIST ] :SWEep:TIME:AUTO OFF|ON|0|1, OFF|ON|0|1
```

```
[ :SENSe ] :SPURious [ :RANGe ] [ :LIST ] :SWEep:TIME:AUTO?
```

```
[ :SENSe ] :SPURious [ :RANGe ] [ :LIST ] :SWEep:TIME: <time>, <time>, ... (up to 20  
sweeptimes)
```

```
[ :SENSe ] :SPURious [ :RANGe ] [ :LIST ] :SWEep:TIME?
```

Remote Command Notes: This parameter can receive up to 20 values. The location in the list sent corresponds to the range the value is associated with. Missing values are not permitted, for example, if you want to change values 2 and 6, you must send all values up to 6. Subsequent values will remain as they were.

The query for this parameter will always return 20 values.

Example: `[:SENSe]:SPURious[:RANGe][:LIST]:SWEep:TIME:AUTO ON,OFF,ON`
`[:SENSe]:SPURious[:RANGe][:LIST]:SWEep:TIME: 4ms,10ms`

5.27.3.7 Abs Start Limit

Abs Start Limit is used to set the absolute start limit to the set value, then sets the absolute stop limit to the same value as the start limit. If any spurs are located above the current setting of **Peak Excursn** will be added to the results table. A red F will be appended to the amplitude value of the spur if the measured amplitude of the spur is above the limit set with **Abs Start Limit**.

Key Path: **Meas Setup, Range Table**

Dependencies/

Couplings: If the limit is set to **Auto**, **Abs Start Limit** and **Abs Stop Limit** are coupled to make a flat limit line. If set to **Man**, the absolute start and stop limits can take different values to make a sloped limit line.

Factory Preset: See [“Range Table” on page 486](#).

Knob Increment: 0.1 dB

Step Key

Increment: 1 dB

Range: -150 dBm to 50 dBm

History: Added with firmware revision A.03.00

Remote Command:

`:CALCulate:SPURious[:RANGe][:LIST]:LIMit:ABSolute[:UPPER]:DATA:START`
`<integer>`

`:CALCulate:SPURious[:RANGe][:LIST]:LIMit:ABSolute[:UPPER]:DATA:START?`

Remote Command Notes: This parameter can receive up to 20 values. The location in the list sent corresponds to the range the value is associated with. Missing values are not permitted, for example, if you want to change values 2 and 6, you must send all values up to 6. Subsequent values will remain as they were.

The query for this parameter will always return 20 values.

Related commands are

`[:SENSe]:SPURious[:RANGe][:LIST]:SWEep:TIME:AUTO?`

`[:SENSe]:SPURious[:RANGe][:LIST]:SWEep:TIME?`

5.27.3.8 Abs Stop Limit

Abs Stop Limit is used to determine the limit above which spurs will report a failure. If any spurs are located above the current setting of **Peak Excursn** will be added to the results table. A red F will be appended to the amplitude value of the spur if the measured amplitude of the spur is above the limit set with **Abs Stop Limit**.

Key Path: **Meas Setup, Range Table**

Dependencies/

Couplings: If the limit is set to **Auto**, **Abs Start Limit** and **Abs Stop Limit** are coupled to make a flat limit line. If set to **Man**, the absolute start and stop limits can take different values to make a sloped limit line.

Factory Preset: See “[Range Table](#)” on page 486.

Knob Increment: 0.1 dB

Step Key

Increment: 1 dB

Range: -150 dBm to 50 dBm

History: Added with firmware revision A.03.00

Remote Command:

```
:CALCulate:SPURious[:RANGE] [:LIST] :LIMit:ABSolute[:UPPER] :DATA:STOP
<integer>, <integer>
```

```
:CALCulate:SPURious[:RANGE] [:LIST] :LIMit:ABSolute[:UPPER] :DATA:STOP?
```

```
:CALCulate:SPURious[:RANGE] [:LIST] :LIMit:ABSolute[:UPPER] :DATA:STOP:AUTO
OFF|ON|0|1, OFF|ON|0|1
```

```
:CALCulate:SPURious[:RANGE] [:LIST] :LIMit:ABSolute[:UPPER] :DATA:STOP:AUTO?
```

Remote Command Notes: This parameter can receive up to 20 values. The location in the list sent corresponds to the range the value is associated with. Missing values are not permitted, for example, if you want to change values 2 and 6, you must send all values up to 6. Subsequent values will remain as they were.

The query for this command will always return 20 values.

Example: :CALC:SPUR:LIM:ABS:DATA -23, -27

```
:CALC:SPUR:LIM:ABS:DATA:AUTO ON, ON, ON, ON
```

5.27.3.9 Peak Excursn

Peak Excursn sets the minimum amplitude variation of signals that can be identified as peaks. For example, if a value of 6 dB is selected, peaks that rise and fall more than the 6 dB above the peak threshold value are identified.

Key Path: **Meas Setup, Range Table**

Factory Preset: See [“Range Table” on page 486](#).

Knob Increment: 1 dB

Step Key

Increment: 1 dB

Range: 0.0 dB to 100.0 dB

Remote Command:

This parameter can receive up to 20 values. The location in the list sent corresponds to the range the value is associated with. Missing values are not permitted, for example, if you want to change values 2 and 6, you must send all values up to 6. Subsequent values will remain as they were.

```
[ :SENSE ] :SPURious [ :RANGE ] [ :LIST ] :PEAK:EXCURsion <integer>
```

The query for this parameter will always return 20 values.

```
[ :SENSE ] :SPURious [ :RANGE ] [ :LIST ] :PEAK:EXCURsion?
```

5.27.3.10 Pk Threshold

Pk Threshold sets the minimum amplitude of signals that can be identified as peaks. For example, if a value of -90 dBm is selected, only peaks that rise and fall more than the peak excursion value which is above -90 dBm are identified.

Key Path: **Meas Setup, Range Table**

Factory Preset: See [“Range Table” on page 486](#).

Knob Increment: 1 dB

Step Key

Increment: 1 dB

Range: -100 dB to 0.0 dB

Remote Command:

This parameter can receive up to 20 values. The location in the list sent corresponds to the range the value is associated with. Missing values are not permitted, for example, if you want to change values 2 and 6, you must send all values up to 6. Subsequent values will remain as they were.

```
[ :SENSE ] :SPURious [ :RANGE ] [ :LIST ] :PEAK:THReshold <integer>
```

The query for this parameter will always return 20 values.

[:SENSE] :SPURious [:RANGE] [:LIST] :PEAK:THReshold?

5.27.4 Meas Type

Specifies the measurement type (**Examine** or **Full**). This parameter is coupled to the average mode. If you select **Examine**, the measurement sets **Avg Mode** to **Exp**. If you select **Full**, the measurement sets **Avg Mode** to **Rep**. The behavior of each measurement type is described below.

	Single		Continuous	
	No Spurs	Spurs	No Spurs	Spurs
Examine	<p>All active ranges are measured.</p> <p>Upon completion, the measurement is set to the idle state.</p> <p>The message No Spurs is displayed.</p>	<p>All active ranges are measured and the found spurs are reported.</p> <p>Upon completion, the measurement is set to the idle state.</p> <p>The trace containing the worst spur is restored.</p> <p>Spur is enabled (no longer greyed out).</p> <p>A marker is added, set to the frequency of the worst spur.</p>	<p>All active ranges are measured.</p> <p>Upon completion, the analyzer remains set to the last range checked with an active trace.</p> <p>The message No Spurs is displayed.</p>	<p>All active ranges are measured and the found spurs are reported.</p> <p>Upon completion the analyzer is set to the range containing the worst spur found and continually sweeps this range.</p> <p>Spur is enabled (no longer greyed out).</p> <p>A marker added, set to the frequency of the worst spur.</p>
Full	<p>All active ranges are measured.</p> <p>Upon completion, the measurement is set to the idle state.</p> <p>The message No Spurs is displayed.</p>	<p>All active ranges are measured and the found spurs are reported.</p> <p>Upon completion, the measurement is set to the idle state.</p> <p>The trace of the last active range is displayed.</p>	<p>Measurement continually cycles through all active ranges.</p>	<p>All active ranges are measured and the found spurs are reported.</p> <p>On each cycle of the active ranges, the report on spurs found is reset. This ensures that remote queries retrieve the trace data that matches the currently displayed results.</p>

Key Path: **Meas Setup**

State Saved: Saved in instrument state.

Factory Preset: Examine

Range: Examine | Full

Remote Command:

```
[ :SENSe] :SPURious:TYPE EXAMine|FULL
```

```
[ :SENSe] :SPURious:TYPE?
```

Remote Command Notes n/a

Example: SPUR:TYPE FULL

5.27.5 Spur

Enables you to view any spurs that have been found. The measurement sets the analyzer to the range in which the currently selected spur was found. The range settings changes only if the selected spur is in the range that is different from the current range settings. A marker identifies the currently selected spur on the trace.

NOTE This key is enabled only when **Meas Type** is set to **Examine**, and only upon completion of a measurement.

Key Path: **Meas Setup**

Saved State: No values are saved to state.

Factory Preset: 1

Knob Increment: 1

Step Key

Increment: 1

Range: 1 to 100

Remote Command:

```
[ :SENSe] :SPURious:SPUR <integer>
```

```
[ :SENSe] :SPURious:SPUR?
```

5.27.6 Ref Level

Pressing **Ref Level** sets the reference level of the analyzer.

Key Path: **Meas Setup**

Saved State: Ref Level state is saved to instrument state. Ref Level value is recalculated for each active range the value is not stored in instrument state.

Factory Preset: 0.00 dBm

Knob Increment: 1

Step Key

Increment: 10
 Range: -180 dBm to 20 dBm

Remote Command:

```
[ :SENSe] :SPURious:POWer[:RF]:LEVel <integer>
[ :SENSe] :SPURious:POWer[:RF]:LEVel?
[ :SENSe] :SPURious:POWer[:RF]:RANGe:AUTO OFF|ON|0|1
[ :SENSe] :SPURious:POWer[:RF]:RANGe:AUTO?
```

Example: SPUR:POW:RF:LEV 10
 SPUR:POW:RF:RANG:AUTO ON

5.27.7 Fast Spurious Meas

Pressing **Fast Spurious Meas** turns the fast spurious measurement test on or off. Pressing **Fast Spurious Meas** to **On** provides a faster method of execution as with fast spurious testing spurs above the limit line are reported. Any spurs reported outside the limit will cause the measurement to fail. See [“Abs Start Limit” on page 493](#) for more information.

Key Path: Meas Setup

Saved State: Ref Level state is saved to instrument state. Ref Level value is recalculated for each active range the value is not stored in instrument state.

Factory Preset: Off

Range: Off|On

History: Add with firmware revision A.03.00

Remote Command:

```
[ :SENSe] :SPURious:FSMeas OFF|ON|0|1
[ :SENSe] :SPURious:FSMeas?
```

Example: SPUR:FSM ON

6 Programming Fundamentals

- “SCPI Language Basics” on page 503
- “Improving Measurement Speed” on page 511
- “Programming Command Compatibility Across Model Numbers and Across Modes” on page 519
- “Using the LAN to Control the Instrument” on page 524
- “Programming in C Using the VTL” on page 546
- “Overview of the GPIB Bus” on page 554

SCPI Language Basics

This section is not intended to teach you everything about the SCPI (Standard Commands for Programmable Instruments) programming language. The SCPI Consortium or IEEE can provide that level of detailed information.

Topics covered in this chapter include:

- “Creating Valid Commands” on page 504
- “Command Keywords and Syntax” on page 503
- “Special Characters in Commands” on page 505
- “Parameters in Commands” on page 506
- “Putting Multiple Commands on the Same Line” on page 508

For more information refer to:

IEEE Standard 488.1-1987, *IEEE Standard Digital Interface for Programmable Instrumentation*. New York, NY, 1998.

IEEE Standard 488.2-1987, *IEEE Standard Codes, Formats, Protocols and Comment Commands for Use with ANSI/IEEE Std488.1-1987*. New York, NY, 1998.

Command Keywords and Syntax

A typical command is made up of keywords set off by colons. The keywords are followed by parameters that can be followed by optional units.

Example: `SENSe:FREQuency:STARt 1.5 MHz`

The instrument does not distinguish between upper and lower case letters. In the documentation, upper case letters indicate the short form of the keyword. The lower case letters, indicate the long form of the keyword. Either form may be used in the command.

Example: `Sens:Freq:Star 1.5 mhz`

is the same as `SENSE:FREQ:start 1.5 MHz`

NOTE

The command `SENS:FREQ:STAR` is not valid because `FREQU` is neither the short, nor the long form of the command. Only the short and long forms of the keywords are allowed in valid commands.

Creating Valid Commands

Commands are not case sensitive and there are often many different ways of writing a particular command. These are examples of valid commands for a given command syntax:

Command Syntax	Sample Valid Commands
[SENSe:]BANDwidth[:RESolution] <freq>	<p>The following sample commands are all identical. They will all cause the same result.</p> <ul style="list-style-type: none"> • Sense:Band:Res 1700 • BANDWIDTH:RESOLUTION 1.7e3 • sens:band 1.7KHZ • SENS:band 1.7E3Hz • band 1.7kHz • bandwidth:RES 1.7e3Hz
MEASure:SPECTrum[n] ?	<ul style="list-style-type: none"> • MEAS:SPEC? • Meas:spec? • meas:spec3? <p>The number 3 in the last meas example causes it to return different results then the commands above it. See the command description for more information.</p>
[[:SENSE]:DETECTOR[:FUNCTION] NEGative POSitive SAMPLE	<ul style="list-style-type: none"> • DET:FUNC neg • Detector:Func Pos
INITiate:CONTinuous ON OFF 1 0	<p>The sample commands below are identical.</p> <ul style="list-style-type: none"> • INIT:CONT ON • init:continuous 1

Special Characters in Commands

Special Character	Meaning	Example
	A vertical stroke between parameters indicates alternative choices. The effect of the command is different depending on which parameter is selected.	<p>Command: TRIGger:SOURCE EXTernal INTernal LINE</p> <p>The choices are external, internal, and line. Ex: TRIG:SOURCE INT</p> <p>is one possible command choice.</p>
	A vertical stroke between keywords indicates identical effects exist for both keywords. The command functions the same for either keyword. Only one of these keywords is used at a time.	<p>Command: SENSE:bandwidth BWIDTH: OFFSet</p> <p>Two identical commands are: Ex1: SENSE:BWIDTH:OFFSET Ex2: SENSE:BAND:OFFSET</p>
[]	keywords in square brackets are optional when composing the command. These implied keywords will be executed even if they are omitted.	<p>Command: [SENSE:]BANDwidth[:RESolu tion]:AUTO</p> <p>The following commands are all valid and have identical effects: Ex1: bandwidth:auto Ex2: band:resolution:auto Ex3: sense:bandwidth:auto</p>
< >	Angle brackets around a word, or words, indicates they are not to be used literally in the command. They represent the needed item.	<p>Command: SENS:FREQ <freq></p> <p>In this command example the word <freq> should be replaced by an actual frequency. Ex: SENS:FREQ 9.7MHz.</p>
{ }	Parameters in braces can optionally be used in the command either not at all, once, or several times.	<p>Command: MEASure:BW <freq>{,level}</p> <p>A valid command is: meas:BW 6 MHz, 3dB, 60dB</p>

Parameters in Commands

There are four basic types of parameters: booleans, keywords, variables and arbitrary block program data.

OFF|ON|0|1

(Boolean) This is a two state boolean-type parameter. The numeric value 0 is equivalent to OFF. Any numeric value other than 0 is equivalent to ON. The numeric values of 0 or 1 are commonly used in the command instead of OFF or ON. Queries of the parameter always return a numeric value of 0 or 1.

keyword The keywords that are allowed for a particular command are defined in the command syntax description.

Units Numeric variables may include units. The valid units for a command depend on the variable type being used. See the following variable descriptions. The indicated default units will be used if no units are sent. Units can follow the numerical value with, or without, a space.

Variable A variable can be entered in exponential format as well as standard numeric format. The appropriate range of the variable and its optional units are defined in the command description.

The following keywords may also be used in commands, but not all commands allow keyword variables.

- DEFault - resets the parameter to its default value.
- UP - increments the parameter.
- DOWN - decrements the parameter.
- MINimum - sets the parameter to the smallest possible value.
- MAXimum - sets the parameter to the largest possible value.

The numeric value for the function's MINimum, MAXimum, or DEFault can be queried by adding the keyword to the command in its query form. The keyword must be entered following the question mark.

Example query: SENSE:FREQ:CENTER? MAX

Variable Parameters

<freq>	
<bandwidth>	Is a positive rational number followed by optional units. The default unit is Hz. Acceptable units include: HZ, KHZ, MHZ, GHZ.
<time>	
<seconds>	Is a rational number followed by optional units. The default units are seconds. Acceptable units include: S, MS, US.
<voltage>	Is a rational number followed by optional units. The default units are V. Acceptable units include: Volts, V, MV, UV.
<power>	
<ampl>	Is a rational number followed by optional units. The default units are dBm. Acceptable units include: DBM, DBMV, W.
<rel_power>	
<rel_ampl>	Is a positive rational number followed by optional units. The default units are dB. Acceptable units include: DB.
<angle>	
<degrees>	Is a rational number followed by optional units. The default units are degrees. Acceptable units include: DEG, RAD.
<integer>	An integer value has no units.
<real>	Is a floating point number, with no units.
<percent>	Is a rational number between 0 and 100, with no units.
<string>	Is a series of alpha numeric characters.
<bit_pattern>	Specifies a series of bits rather than a numeric value. The bit series is the binary representation of a numeric value. There are no units.

Bit patterns are most often specified as hexadecimal numbers, though octal, binary or decimal numbers may also be used. In the SCPI language these numbers are specified as:

- Hexadecimal, #Hdddd or #hdddd where 'd' represents a hexadecimal digit 0 to 9 and 'a' to 'f'. So #h14 can be used instead of the decimal number 20.
- Octal, #Odddd or #odddd where 'd' represents an octal digit 0 to 7. So #o24 can be used instead of the decimal number 20.

- Binary, #Bdddddddddddddd or #bdddddddddddddd where 'd' represents a 1 or 0. So #b10100 can be used instead of the decimal number 20.

Block Program Data

Some parameters consist of a block of data. Block data There are a few standard types of block data. Arbitrary blocks of program data can also be used.

<trace> Is an array of rational numbers corresponding to displayed trace data. See FORMat:DATA for information about available data formats.

A SCPI command often refers to a block of current trace data with a variable name such as: Trace1, TRACE2, or trace3, depending on which trace is being accessed.

<arbitrary block data> Consists of a block of data bytes. The first information sent in the block is an ASCII header beginning with #. The block is terminated with a semi-colon. The header can be used to determine how many bytes are in the data block. There are no units.

For example, suppose the header is #512320.

- The first digit in the header (5) tells you how many additional digits/bytes there are in the header.
- The 12320 means 12 thousand, 3 hundred, 20 data bytes follow the header.
- Divide this number of bytes by your current data format (bytes/data point), either 8 (for real64), or 4 (for real32). For this example, if you're using real64 then there are 1540 points in the block.

Putting Multiple Commands on the Same Line

Multiple commands can be written on the same line, reducing your code space requirement. To do this:

- Commands must be separated with a semicolon (;).
- If the commands are in different subsystems, the key word for the new subsystem must be preceded by a colon (:).
- If the commands are in the same subsystem, the full hierarchy of the command key words need not be included. The second command can start at the same key word level as the command that was just executed.

SCPI Termination and Separator Syntax

A terminator must be provided when an instrument is controlled using RS-232. There are several issues to be understood about choosing the proper SCPI terminator and separator when this is the case. There is no current SCPI standard for RS-232. Although one intent of SCPI is to be interface independent, <END> is only defined for IEEE 488 operation. At the time of this writing, the RS-232 terminator issue was in the process of being addressed in IEEE standard 1174.

A semicolon (;) is not a SCPI terminator, it is a separator. The purpose of the separator is to queue multiple commands or queries in order to obtain multiple actions and/or responses. Make sure that you do not attempt to use the semicolon as a terminator when using RS-232 control.

All binary trace and response data is terminated with <NL><END>, as defined in Section 8.5 of IEEE Standard 488.2-1992, *IEEE Standard Codes, Formats, Protocols and Common Commands for Use with ANSI/IEEE Std 488.1-1987*. New York, NY, 1992.

The following are some examples of good and bad commands. The examples are created from a theoretical instrument with the simple set of commands indicated below:

```
[ :SENSe]
    :POWer
        [:RF]
        :ATTenuation 40dB

:TRIGger
    [:SEQuence]
    :EXTernal [1]
        :SLOPe
            POSitive
```

```
[ :SENSe]
  :FREQuency
    :STARt
  :POWer
  [ :RF]
    :MIXer
      :RANGe
        [ :UPPer]
```

Bad Command	Good Command
PWR:ATT 40dB	POW:ATT 40dB
The short form of POWER is POW, not PWR.	
FREQ:STAR 30MHz;MIX:RANG -20dBm	FREQ:STAR 30MHz;POW:MIX:RANG -20dBm
The MIX:RANG command is in the same :SENSE subsystem as FREQ, but executing the FREQ command puts you back at the SENSE level. You must specify POW to get to the MIX:RANG command.	
FREQ:STAR 30MHz;POW:MIX RANG -20dBm	FREQ:STAR 30MHz;POW:MIX:RANG -20dBm
MIX and RANG require a colon to separate them.	
:POW:ATT 40dB;TRIG:FREQ:STAR 2.3GHz	:POW:ATT 40dB;:FREQ:STAR 2.3GHz
:FREQ:STAR is in the :SENSE subsystem, not the :TRIGGER subsystem.	
:POW:ATT?::FREQ:STAR?	:POW:ATT?;:FREQ:STAR?
:POW and FREQ are within the same :SENSE subsystem, but they are two separate commands, so they should be separated with a semicolon, not a colon.	
:POW:ATT -5dB;:FREQ:STAR 10MHz	:POW:ATT 5dB;:FREQ:STAR 10MHz
Attenuation cannot be a negative value.	

Improving Measurement Speed

There are a number of things you can do in your programs to make them run faster:

“Turn off the display updates.” on page 511

“Use binary data format instead of ASCII” on page 512

“Minimize the number of GPIB transactions.” on page 512

“Put ADC Ranging in Bypass for FFT Measurements” on page 513

“Minimize DUT/instrument setup changes.” on page 513

“Consider using LAN instead of GPIB.” on page 514

There are additional things you can do to run faster if you are using a measurement personality option (i.e. instrument Modes other than the standard Spectrum Analysis Mode). These considerations only apply to specific option modes.

“Using an Option Mode: Minimize the number of GPIB transactions.” on page 514

“Using an Option Mode: Avoid automatic attenuator setting.” on page 515

“Using an Option Mode: Optimize your GSM output RF spectrum switching measurement.” on page 515

“Using an Option Mode: Avoid using RFBurst trigger for single burst signals.” on page 515

“Using an Option Mode: When making power measurements on multiple bursts or slots, use CALCulate:DATA<n>:COMPRESS?” on page 516

Turn off the display updates.

`:DISPlay:ENABle OFF` turns off the display. That is, the data may still be visible, but it will no longer be updated. Updating the display slows down the measurement. For remote testing, since the computer is processing the data rather than a person, there is no need to display the data on the analyzer screen.

Use binary data format instead of ASCII

The ASCII data format is the instrument default since it is easier for people to understand and is required by SCPI for *RST. However, data input/output is faster using the binary formats.

:FORMat:DATA REAL,64 selects the 64-bit binary data format for all your numerical data queries. You may need to swap the byte order if you are using a PC rather than UNIX. **NORMal** is the default byte order. Use **:FORMat:BOReDer SWAP** to change the byte order so that the least significant byte is sent first. (Real,32 which is smaller and somewhat faster, should only be used if you don't need full resolution for your data. Some frequency data may require full 64 bit resolution.)

When using the binary format, data is sent in a block of bytes with an ASCII header. A data query would return the block of data in the following format: `#DNNN<nnn binary data bytes>`

To parse the data:

- Read two characters (#D), where D tells you how many N characters follow the D character.
- Read D characters, the resulting integer specifies the number of data bytes sent.
- Read the bytes into a real array.

For example, suppose the header is #512320.

- The first character/digit in the header (5) tells you how many additional digits there are in the header.
- The 12320 means 12 thousand, 3 hundred, 20 data bytes follow the header.
- Divide this number of bytes by your current data format (bytes/data point), 8 for real,64. For this example, there are 1540 data points in the block of data.

Minimize the number of GPIB transactions.

When you are using the GPIB for control of your instrument, each transaction requires driver overhead and bus handshaking, so minimizing these transactions reduces the time used.

You can reduce bus transactions by sending multiple commands per transaction. See the information on “Putting Multiple Commands on the Same Line” in the SCPI Language Basics section.

If you are using the **MEASURE** key measurements and are making the same measurement multiple times with small changes in the measurement setup, use the single **READ** command. It is faster than using **INITiate** and **FETCh**.

Avoid unnecessary use of *RST.

Remember that while *RST does not change the current Mode, it presets all the measurements and settings to their factory defaults. This forces you to reset your analyzer's measurement settings even if they use similar mode setup or measurement settings. See [Minimize DUT/instrument setup changes](#). below. (Also note that *RST may put the instrument in single measurement/sweep for some modes.)

Put ADC Ranging in Bypass for FFT Measurements

Setting ADC ranging to the Bypass mode can speed FFT measurements up by 10% to 50%. (Use ADC:RANG NONE) Bypass allows triggered FFT measurements to occur at the trigger time instead of following an autoranging time, so it can improve measurement speed. It does, however, add additional noise degrading your signal to noise level, so it should be used carefully.

Minimize DUT/instrument setup changes.

- Some instrument setup parameters are common to multiple measurements. You should look at your measurement process with an eye toward minimizing setup changes. If your test process involves nested loops, make sure that the inner-most loop is the fastest. Also, check if the loops could be nested in a different order to reduce the number of parameter changes as you step through the test.
- Are you are using the measurements under the **MEASURE** key? Remember that if you have already set your Meas Setup parameters for a measurement, and you want to make another one of these measurements later, use `READ:<meas>?`. The `MEASure:<meas>?` command resets all the settings to the defaults, while `READ` changes back to that measurement without changing the setup parameters from the previous use.
- Are you are using the Measurements under the **MEASURE** key? Remember that *Mode Setup* parameters remain constant across all the measurements in that mode (e.g. center/channel frequency, amplitude, radio standard, input selection, trigger setup). You don't have to re-initialize them each time you change to a different measurement.

Consider using LAN instead of GPIB.

LAN allows faster I/O of data, especially if you are moving large blocks of data. You will not get this improved throughput if there is excessive LAN traffic (i.e. your test instrument is connected to enterprise LAN). You may want to use a private LAN that is only for your test system.

Using an Option Mode: Minimize the number of GPIB transactions.

When you are using the GPIB for control of your instrument, each transaction requires driver overhead and bus handshaking, so minimizing these transactions reduces the time used.

- You can reduce bus transactions by sending multiple commands per transaction. See the information on “Putting Multiple Commands on the Same Line” in the SCPI Language Basics section.
- If you are making the same measurement multiple times with small changes in the measurement setup, use the READ command. It is faster than using INITiate and FETCh.
- If you are changing the frequency and making a measurement repeatedly, you can reduce transactions by sending the optional frequency parameter with your READ command. (for example, READ:<meas>? {<freq>}) These optional parameters are not available in some personality modes such as Spectrum Analysis or Phase Noise.

The CONFigure/MEASure/READ commands for measurements in the option Modes allow you to send center frequency setup information along with the command. (for example, MEAS:PVT? 935.2MHz) This sets the power vs. time measurement to its defaults, then changes the center frequency to 935.2 MHz, initiates a measurement, waits until it is complete and returns the measurement data.

- If you are doing bottom/middle/top measurements on base stations, you can reduce transactions by making a time slot active at each of the B,M,T frequencies. Then issue three measurements at once in the programming code and retrieve three data sets with just one GPIB transaction pair (write, read).

For example, send READ:PFER? <Freq_bottom>;PFER? <Freq_middle>;PFER? <Freq_top> This single transaction initiates three different phase and frequency error measurements at each of the three different frequencies provided and returns the data. Then you read the three sets of data.

Using an Option Mode: Avoid automatic attenuator setting.

The internal process for automatically setting the value of the attenuator requires measuring an initial burst to identify the proper attenuator setting before the next burst can be measured properly. If you know the amount of attenuation or the signal level needed for your measurement, just set it.

Note that spurious types of measurements must be done with the attenuator set to automatic (for measurements like: output RF spectrum, transmit spurs, adjacent channel power, spectrum emission mask). These types of measurements start by tuning to the signal, then they tune away from it and must be able to reset the attenuation value as needed.

Using an Option Mode: Optimize your GSM output RF spectrum switching measurement.

For ORFS (switching), setting the break frequency to zero (0) puts the analyzer in a measurement setup where it can use a direct time measurement algorithm, instead of an FFT-based algorithm. This non-FFT approach is faster. (However, remember that your break frequency for ORFS (modulation) measurements must be >400 kHz for valid measurements, so you will need to change the break frequency if you are making both types of measurements.)

Using an Option Mode: Avoid using RFBurst trigger for single burst signals.

RFBurst triggering works best when measuring signals with repetitive bursts. For a non-repetitive or single burst signals, use the IF(video) trigger or external trigger, depending on what you have available.

RFBurst triggering depends on its establishment of a valid triggering reference level, based on previous bursts. If you only have a single burst, the peak detection nature of this triggering function, may result in the trigger being done at the wrong level/point generating incorrect data, or it may not trigger at all.

Are you making a single burst measurement?

To get consistent triggering and good data for this type of measurement application, you need to synchronize the triggering of the DUT with the analyzer. You should use the analyzer's internal status system for this.

The first step in this process is to initialize the status register mask to look for the "waiting for trigger" condition (bit 5). Use

```
:STATus:OPERation:ENABLE 32
```

Then, in the measurement loop:

1. `:STATUS:OPERation:EVENT?` This query of the operation event register is to clear the current register contents.
2. `:READ:PVT?` initiates a measurement (in this example, for GSM power versus time) using the previous setup. The measurement will then be waiting for the trigger.

Make sure the attenuation is set manually. Do NOT use automatic attenuation as this requires an additional burst to determine the proper attenuation level before the measurement can be made.

3. Create a small loop that will serial poll the instrument for a status byte value of binary 128. Then wait 1 msec (100 ms if the display is left on/enabled) before checking again, to keep the bus traffic down. These two commands are repeated until the condition is set, so we know that the trigger is armed and ready.
4. Trigger your DUT to send the burst.
5. Return the measurement data to your computer.

This process cannot be done by using with the current VXI plug-n-play driver implementation. You will need to use the above SCPI commands.

Using an Option Mode: When making power measurements on multiple bursts or slots, use `CALCulate:DATA<n>:COMPress?`

The `CALC:DATA:COMP?` query is the fastest way to measure power data for multiple bursts/slots. There are two reasons for this: 1. it can be used to measure data across multiple, consecutive slots/frames with just one measurement, instead of a separate measurement on each slot, and 2. it can pre-process and/or decimate the data so that you only return the information that you need which minimizes data transfer to the computer.

For example: let's say you want to do a power measurement for a GSM base station where you generate a repeating frame with 8 different power levels. You can gather all the data with a single `CALC:DATA:COMP?` acquisition, using the waveform measurement.

With `CALC:DATA2:COMP? MEAN,9,197,1730` you can measure the mean power in those bursts. This single command will measure the data across all 8 frames, locate the first slot/burst in each of the frames, calculate the mean power of those bursts, then return the resulting 8 values.

NOTE

For later version of firmware (after A.02.00) you can use equivalent time values for the `CALC:DATA<n>:COMP?` query. The command would then be `CALC:DATA2:COMP? MEAN,25us,526us,579.6us,8`

Let's set up the GSM Waveform measurement:

- `:CONF:WAV?` turns on the waveform measurement
- `:WAV:BAND 300khz` sets a resolution bandwidth of 300 kHz
- `:WAV:SWE:TIME 5ms` sets a sweep time of 5 milliseconds
- `:WAV:BAND:TYPE FLAT` selects the flat filter type
- `:WAV:DEC 4;DEC:STAT ON` selects a decimation of 4 and turns on decimation. This reduces the amount of data that needs to be sent since the instrument hardware decimates (throws some away).
- `:INIT` to initiate a measurement and acquire the data
- `CALC:DATA2:COMP? MEAN, 25us, 526us, 579.6us, 8` to return the desired data

There are two versions of this command depending on your firmware revision. Earlier revisions require the optional variables be entered in terms of their position in the trace data array. Current instruments allow the variables to be entered in terms of time.

For early firmware revisions you need to know the sample interval. In the waveform measurement it is equal to the aperture value. Query `:WAVEform:APERture?` to find the sample interval. (Note: the `WAV:APER?` command always takes decimation into account.) The sample interval (aperture value) is dependent on the settings for resolution bandwidth, filter type, and decimation. See the following table to see how these value relate.

The parameters for this GSM example are:

`MEAN, 9, 197, 1730` (or with later firmware:

`MEAN, 25us, 526us, 579.6us, 8`)

- `MEAN` calculates the mean of the measurement points indicated
- `9` is how many points you want to discard before you look at the data. This allows you to skip over any “unsettled” values at the beginning of the burst. You can calculate this start offset by $(25\mu\text{s}/\text{sampleInterval})l$
- `197` is the length of the data you want to use. This would be the portion of the burst that you want to find the mean power over. You can calculate this length by $(526\mu\text{s}/\text{sampleInterval})$
- `1730` is how much data you have before you repeat the process. For this example it’s the time between the start offset point on the burst in the first slot (first frame) to the same spot on the burst in the first slot (second frame). You can calculate this by $(576.9\mu\text{s} * N / \text{sampleInterval})$ where `N` is the number of data items that you want. In this case it is the number of slots in the frame, `N=8.`)

Table 6-1 GSM Parameters for 1 Slot/Frame Measurement Requirements

Resolution Bandwidth	Filter Type	Decimation	Aperture	Start	Length	Repeat
500 or 300 kHz	Flat or Gaussian	4 or 1	dependent on settings	24 μsec^a	526 μsec^a	576.9 μsec^a
500 kHz	Gaussian	1	0.2 μsec	124	2630	2884.6
500 kHz	Gaussian	4	0.8 μsec	31	657	721.15
500 kHz	Flat	1	0.4 μsec	61	1315	1442.3
500 kHz	Flat	4	1.6 μsec	15	329	360.575
300 kHz	Gaussian	1	0.2667 μsec	90	1972	2163.1
300 kHz	Gaussian	4	1.07 μsec	22	492	539.16
300 kHz	Flat	1	0.6667 μsec	36	789	865.31
300 kHz	Flat	4	2.667 μsec	9	197	216.33

a. The use of time values is only allowed in firmware versions of A.02.00 and later.

Programming Command Compatibility Across Model Numbers and Across Modes

Across PSA Modes: Command Subsystem Similarities

When you select different modes you get different sets of available programming commands. That is, *only* the commands that are appropriate for the current mode are available. Also, some commands have the same syntax in different modes but have different ranges or settings that are only appropriate to the current mode.

The following table shows which command subsystems are the same across different modes. If there is no “X” by a particular subsystem, then the set of available commands is different in those modes. Command ranges or defaults may also be different. Refer to the programming command descriptions in the documentation for each mode for details.

Command Subsystem	Same command set is available: SA mode compared with the application modes: W-CDMA, cdmaOne, cdma2000, 1xEV-DO, Basic, GSM, EDGE, NADC, or PDC	Same command set is available: SA mode compared with the application mode: Phase Noise
IEEE common commands	X	X
ABORt	X	X
CALCulate		
CALibration	X	X
CONFigure		
COUPlE	not available in these application modes	not available in this application modes
DISPlay		
FETCh		
FORMat		X
HCOPy	X	X
INITiate		
INPut	not available in these application modes	X

Command Subsystem	Same command set is available: SA mode compared with the application modes: W-CDMA, cdmaOne, cdma2000, 1xEV-DO, Basic, GSM, EDGE, NADC, or PDC	Same command set is available: SA mode compared with the application mode: Phase Noise
MEASure		
MEMory	X	X
MMEMory	X	X
MMEMory:STORe:TRACe	not available in application modes	X
READ		
[SENSe] [SENSe:]CHANnel [SENSe:]CORRection [SENSe:]FEED [SENSe:]FREQUency:CENTer [SENSe:]FREQUency: <other subsystems> [SENSe:]<measurement> [SENSe:]POWer [SENSe:]RADio [SENSe:]SYNC	X not available in application modes	 not available in application modes
STATus	X	X
SYSTem	X	X
TRACe	not available in application modes	X
TRIGger		
UNIT	X	X

Across PSA Modes: Specific Command Differences

Some programming commands operate differently depending on which Mode the analyzer is set to.

Command	Spectrum Analysis, Phase Noise and Noise Figure Mode	Basic, cdmaOne, cdma2000, 1xEV-DO, W-CDMA, GSM, EDGE, NADC, PDC Modes
CONFigure: <measurement>	Accesses the measurement and sets the instrument settings to the defaults. Averaging is turned on and set to 10. The instrument is put in single measurement mode. It does not initiate a measurement. Use INIT:IMM to make one measurement.	Accesses the measurement and sets the instrument settings to the defaults. If you were already in single measurement mode, it takes one measurement and then waits. If you were in continuous measurement mode it continues to measure.
*ESE default	Default is 255 which means that every error/status bit change that has occurred will be returned with a *ESR? query. You must set the value of *ESE to choose only the bits/status that you want returned.	Default is 0 which means that none of the error/status bit changes that have occurred will be returned with a *ESR? query. You must set the value of *ESE to choose the bits/status that you want returned.
TRIGger commands	For these modes, only one trigger source can be selected and it will be common across the modes. Also, only one value can be set for the trigger delay, level, or polarity.	For these modes, a unique trigger source can be selected for each mode. Also, each trigger source can have unique settings for the its delay, level, and polarity.
Saving and recalling traces	Traces can only be saved when in the Spectrum Analysis mode (MMEM:STOR:TRAC). This is because the instrument state must be saved along with the trace data and the state data varies depending on the number of modes currently available in the instrument.	

Using Applications in PSA Series vs. VSA E4406A

NOTE

This information *only* applies to the application modes: Basic, cdmaOne, cdma2000, 1xEV-DO, W-CDMA, GSM, EDGE, NADC, and PDC.

Command	PSA Series	VSA E4406A: A.04.00	VSA E4406A: A.05.00
*RST	Resets instrument, putting it in continuous measurement mode. Use INIT:CONT OFF to select single measurement mode and INIT:IMM to start one measurement.	Resets instrument, putting it in single measurement mode. One measurement is initiated when the command is sent.	Resets instrument, putting it in single measurement mode. No measurement is initiated when the command is sent. Use INIT:IMM to start one measurement.
CONFigure: <measurement>	Accesses the measurement and sets the instrument settings to the defaults. If you were already in single measurement mode, it takes one measurement and then waits.	Same as PSA. Accesses the measurement and sets the instrument settings to the defaults. If you were already in single measurement mode, it takes one measurement and then waits.	Accesses the measurement and sets the instrument settings to the defaults. If you were already in single measurement mode, it does not initiate a measurement. Use INIT:IMM to make one measurement.
*ESE default	Default is 255 which means that every error/status bit change that has occurred will be returned with a *ESR? query. You must set the value of *ESE to choose only the bits/status that you want returned.	Default is 0 which means that none of the error/status bit changes that have occurred will be returned with a *ESR? query. You must set the value of *ESE to choose the bits/status that you want returned.	Same as VSA A.04.00. Default is 0 which means that none of the error/status bit changes that have occurred will be returned with a *ESR? query. You must set the value of *ESE to choose the bits/status that you want returned.
*LRN	The command is <i>not</i> available.	The command is available.	The command is available.
TRIGger commands	In Spectrum Analysis mode only one value can be set for the trigger's source, delay, level, or polarity. Basic, GSM, EDGE, cdmaOne, cdma2000, W-CDMA, NADC, PDC modes function the same as VSA	You can select a unique trigger source for each mode. Each trigger source can have unique settings for the its delay, level, and polarity.	Same as VSA A.04.00. You can select a unique trigger source for each mode. Each trigger source can have unique settings for the its delay, level, and polarity.

Command	PSA Series	VSA E4406A: A.04.00	VSA E4406A: A.05.00
AUTO ON OFF control and setting manual values	<p>We recommend that you set a function's automatic state to OFF, before you send it your manual value.</p> <p>Some functions will turn off the automatic mode when you send a specific manual value, but others will not. This also varies with the instrument model.</p>	<p>We recommend that you set a function's automatic state to OFF, before you send it your manual value.</p> <p>Some functions will turn off the automatic mode when you send a specific manual value, but others will not. This also varies with the instrument model.</p>	<p>We recommend that you set a function's automatic state to OFF, before you send it your manual value.</p> <p>Some functions will turn off the automatic mode when you send a specific manual value, but others will not. This also varies with the instrument model.</p>

Using the LAN to Control the Instrument

Refer to the function description chapters for information about configuring the instrument input/output settings from the front panel. Use the SYSTem commands to change settings remotely.

NOTE

Remember that in any type programming using LAN you should avoid constantly opening and closing connections. This uses up processing resources, adds to your system overhead, and can cause problems with asynchronous implementation of successive commands. When you are sending the instrument multiple commands: open the connection, send all the commands, and close the connection.

- [“Using ftp for File Transfers” on page 6-524](#)
- [“Using Telnet to Send Commands” on page 6-527](#)
- [“Using Socket LAN to Send Commands” on page 6-530](#)
- [“Using SICL LAN to Control the Instrument” on page 6-531](#)
- [“Using HP/Agilent VEE Over Socket LAN” on page 6-536](#)
- [“Using a Java™ Applet Over Socket LAN” on page 6-538](#)
- [“Using a C Program Over Socket LAN” on page 6-538](#)
- [“General LAN Troubleshooting” on page 6-538](#)

Using ftp for File Transfers

You can use the instrument LAN connection to transfer files. For example, you can use the ftp functionality to download instrument screen dumps to an external server.

The following is an example of an ftp session from an MSDOS window on a PC:

1. `ftp 141.88.163.118` (enter the instrument IP address, found/set from the front panel by pressing **System, Config I/O**)
2. At the user name prompt, enter: `vsa`
3. At the password prompt, enter: `service`

You are now in the instrument `/users` directory and can get files from the instrument. The ftp commands in the following steps may not all be available from your controller. To show the ftp commands available on your system, type `help` at the prompt. To end the ftp session, type `quit`.

NOTE

Do *not* delete files from this directory. Most of the files are required for

instrument operation, and for the operation of optional personality modes.

4. `cd userdir` (change to the directory where data files are saved)
5. `ls` (list all available files, `ls -la` shows file permissions)
6. `bin` (change to the binary file transfer mode)
7. `get myfilename` (enter the file name; the name *is* case sensitive)

This “gets” (copies) your file. The file is copied to the location you were pointing to when you *started* the ftp process. To query the current location, enter `lcd .` (include the period). To change the current location, enter the desired path/directory location as follows:
`lcd C:\my path\mydir`

NOTE

To use a web browser for this example, enter:
`ftp://vsa:service@141.88.163.118/userdir`

The Standard UNIX FTP Command:

Synopsis `ftp [-g] [-i] [-n] [-v] [server-host] [-B DataSocketBufferSize]`

Description The `ftp` command is used to transfer files using the File Transfer Protocol. `ftp` transfers files over a network connection between a local machine and the remote `server-host`.

Options and Parameters When `ftp` is invoked with a `server-host` specified, a connection is opened immediately. Otherwise, `ftp` waits for user commands.

The following options are supported:

- | | |
|--------------------------|--|
| <code>-g</code> | disables expansion of shell metacharacters in file and directory names |
| <code>-i</code> | disables prompts during multiple-file operations |
| <code>-n</code> | disables automatic log-in |
| <code>-v</code> | enables verbose output |
| <code>-B</code> | specifies a new <code>DataSocketBufferSize</code> |
| <code>server-host</code> | the name or address of the remote host. |

This table lists the available user commands.

Table 6-2 **ftp Commands**

Command	Description
ascii	Sets the file transfer type to ASCII.
binary	Sets the file transfer type to binary.
bye	Closes the connection to the host and exits ftp.
cd <i>remote_directory</i>	Sets the working directory on the host to <i>remote_directory</i> .
delete <i>remote_file</i>	Deletes <i>remote_file</i> or empty <i>remote_directory</i> .
dir [<i>remote_directory</i>]	Lists the contents of the specified <i>remote_directory</i> . If <i>remote_directory</i> is unspecified, the contents of the current remote directory are listed.
get <i>remote_file</i> [<i>local_file</i>]	Copies <i>remote_file</i> to <i>local_file</i> . If <i>local_file</i> is unspecified, ftp uses the <i>remote_file</i> name as the <i>local_file</i> name.
help	Provides a list of ftp commands.
help <i>command</i>	Provides a brief description of <i>command</i> .
image	Sets the file transfer type to binary.
lcd [<i>local_directory</i>]	Sets the local working directory to <i>local_directory</i> .
ls [<i>remote_directory</i>]	Lists the contents of the specified <i>remote_directory</i> . If the <i>remote_directory</i> is unspecified, the contents of the current remote directory are listed.
mget <i>remote_file</i> [<i>local_file</i>]	Copy <i>remote_file</i> to the local system. If <i>local_file</i> is unspecified, ftp uses the <i>remote_file</i> name as the <i>local_file</i> name.
mput <i>local_file</i> [<i>remote_file</i>]	Copies <i>local_file</i> to remote file. If <i>remote_file</i> is unspecified, ftp uses the <i>local_file</i> name as the <i>remote_file</i> name.
put <i>local_file</i> [<i>remote_file</i>]	Copies <i>local_file</i> to <i>remote file</i> . If <i>remote_file</i> is unspecified, ftp uses the <i>local_file</i> name as the <i>remote_file</i> name.
quit	Closes the connection to the host and exits ftp.

Using Telnet to Send Commands

Using telnet to send commands to your instrument works in a similar way to communicating over GPIB. You establish a connection with the instrument, and then send or receive information using SCPI commands.

NOTE

If you need to control the bus using “device clear” or SRQ’s, you can use SICL LAN. SICL LAN provides control of your instrument via IEEE 488.2 GPIB over the LAN. See [“Using SICL LAN to Control the Instrument” on page 6-531](#). in this chapter.

On unix or PC:

The syntax of the telnet command is:

```
telnet <IP address> <5023>
```

The initial telnet connection message will be displayed and then a SCPI> prompt. At the SCPI prompt, simply enter the desired SCPI commands.

On a PC (with telnet gui that has host/port setting menu):

You would type at the dos prompt

```
telnet
```

Unix Telnet Example:

To connect to the instrument with host name aaa and port number 5023, enter the following command:

```
telnet aaa 5023
```

When you connect to the instrument, it will display a welcome message and a command prompt. The instrument is now ready to accept your SCPI commands. As you type SCPI commands, query results appear on the next line. At any time, you can send a <device clear> by pressing `cntrl-c` on your keyboard. When you are done, break the telnet connection using your escape character, and type `quit`.

When the instrument responds with the welcome message and the SCPI prompt, you can immediately enter programming (SCPI) commands. Typical commands might be:

```
CALC:MARK:MODE POS  
CALC:MARK:MAX  
CALC:MARK:X?
```

The small program above sets the instrument to measure a signal amplitude by placing a marker on the maximum point of the trace, and then querying the instrument for the amplitude of the marker.

You need to press Enter after typing in each command. After pressing

Enter on the last line in the example above, the instrument returns the amplitude level of the marker to your computer and displays it on the next line. For example, after typing `CALC:MARK:MAX?` and pressing Enter, the computer could display:

```
+2.500000000000E+010
```

When you are done, close the telnet connection. Enter the escape character to get the telnet prompt. The escape character (Ctrl and "]" in this example) does not print.

At the telnet prompt, type `quit` or `close`.

The telnet connection closes and you see your regular prompt.

```
Connection closed.
```

The following example shows a terminal screen using the example commands above.

Telnet Example:

```
Welcome to at42
Agilent Technologies,E4440A,US41220095,A.02.04 20010921
10:52:07

SCPI>calc:mark:mode pos
SCPI>calc:mark:max
SCPI>calc:mark:x?
+2.5000000000000000E+010
SCPI>
```

NOTE

If your telnet connection is in a mode called “line-by-line,” there is no local echo. This means you will not be able to see the characters you are typing on your computer's display until *after* you press the Enter key.

To remedy this, you need to change your telnet connection to “character-by-character” mode. This can be accomplished in most systems by escaping out of telnet to the `telnet>` prompt and then typing `mode char`. If this does not work, consult your telnet program's documentation for how to change to “character-by-character” mode.

The Standard UNIX TELNET Command:

Synopsis `telnet [host [port]]`

Description The `telnet` command is used to communicate with another host using the TELNET protocol. When `telnet` is invoked with `host` or `port` arguments, a connection is opened to `host`, and input is sent from the user to `host`.

Options and Parameters `telnet` operates in line-by-line mode or in character-at-a-time mode. In line-by-line mode, typed text is first echoed on the screen. When the line is completed by pressing the **Enter** key, the text line is then sent to `host`. In character-at-a-time mode, text is echoed to the screen and sent to `host` as it is typed.

In some cases, if your `telnet` connection is in “line-by-line” mode, there is no local echo. This means you will not be able to see the characters you are typing on your computer's display until *after* you press the **Enter** key.

To remedy this, you need to change your `telnet` connection to “character-by-character” mode. This can be accomplished in most systems by escaping out of `telnet` to the `telnet>` prompt and then typing `mode char`. Consult your `telnet` program's documentation for how to change to “character-by-character” mode.

Using Socket LAN to Send Commands

Your instrument implements a sockets Applications Programming Interface (API) compatible with Berkeley sockets, Winsock, and other standard sockets APIs. You can write programs using sockets to control your instrument by sending SCPI commands to a socket connection you create in your program. Refer to [Using a Java™ Applet Over Socket LAN](#) in this chapter for example programs using sockets to control the instrument.

Setting Up Your Instrument for Socket Programming

Before you can use socket programming, you must identify your instrument's socket port number. The default is 5025.

1. Press **System, Config I/O, SCPI LAN, Socket Port**.
2. Notice that the port number you will use for your socket connection to the instrument is 5025.

NOTE You may need to enable the termination character attribute when using the VISA libraries for socket communication. If the termchar attribute is disabled, then no termination character is sent with the data and the bus will time out waiting for it. (Set vi_attr_termchar_en)

NOTE LAN “device clear” capability has not been implemented in firmware revision A.01.xx.

Troubleshooting help:

You can verify that you can open a socket connection to your instrument by using telnet:

```
telnet <IP address> 5025
```

Characters typed from your keyboard won't be echoed from the instrument and the SCPI prompt won't be given. However, you will be able to send commands and query the instrument. For example, you can type *idn? and the instrument identification string will be returned.

Using SICL LAN to Control the Instrument

SICL LAN is a LAN protocol using the Standard Instrument Control Library (SICL). It provides control of your instrument over the LAN, using a variety of computing platforms, I/O interfaces, and operating systems. With SICL LAN, you control your remote instrument over the LAN with the same methods you use for a local instrument connected directly to the controller with the GPIB. More information about SICL LAN can be found in the *HP Standard Instrument Control Library* user's guide for HP-UX, part number E2091-90004.

Your instrument implements a SICL LAN *server*. To control the instrument, you need a SICL LAN *client* application running on a computer or workstation that is connected to the instrument over a LAN. Typical applications implementing a SICL LAN client include

- HP/Agilent VEE
- HP/Agilent BASIC
- National Instrument's LabView with HP/Agilent VISA/SICL client drivers

NOTE

The SICL LAN protocol is Agilent's implementation of the VXI-11 Instrument Protocol, defined by the VXIbus Consortium working group.

Older versions of National Instruments' VISA does not support the VXI-11 Instrument Protocol. Contact National Instruments for their latest version.

SICL LAN can be used with Windows 95, Windows 98, Windows NT, and HP-UX.

Your instrument has a SICL LAN server to emulate GPIB over LAN, but it cannot be used to control other externally connected GPIB instruments.

Collecting SICL LAN Set-up Information

Before you set up your instrument as a SICL LAN server, you need some information about your instrument. The "value" of the following parameters is used to set up your VISA/SICL LAN client application:

Emulated GPIB

Name The GPIB name is the name given to a device used to communicate with the instrument. Your instrument is shipped with `gpib7` as its GPIB name. The GPIB name is the same as the remote SICL address.

Emulated GPIB

Logical Unit The logical unit number is a unique integer assigned to the device to be controlled using SICL LAN. Your instrument is shipped with the logical unit number set

to 8.

This can't be change, but you don't care. Numbers 0 through 30, excluding 21, are valid logical unit numbers for your instrument. Logical unit number 21 is used for the instrument's internal emulation mode. (If you are using Agilent VEE and SICL LAN, the logical unit number is limited to the range of 0-8.)

Emulated GPIB

Address The emulated GPIB address (bus address) is assigned to the device to be controlled using SICL LAN. The instrument is shipped with the emulated GPIB address set to 18. The emulated GPIB address will always be 18, regardless of what you set the GPIB address to.

The SICL LAN server uses the GPIB name, GPIB logical unit number, and GPIB address configuration on the SICL LAN client to communicate with the client. You must match these parameters *exactly* (including case) when you set up the SICL LAN client and server.

Configuring Your Instrument as a SICL LAN Server

After you have collected the required information from the SICL LAN client, perform the following steps to set up your instrument as a SICL LAN server:

1. Identify the GPIB name.

Press **System, Config I/O, SICL Server, Emulated GPIB Name**, and notice that it is **gpib7**.

2. Notice that the **Emulated GPIB Logical Unit** is set to 8.
3. Notice that the **Emulated GPIB Address** is set to 18.

Configuring a PC as a SICL LAN Client

The descriptions here are based on Agilent's VISA revision G.02.02, model number 2094G. A copy of Agilent VISA instrument io libraries can be found on Agilent's website:

<http://www.agilent.com/find/iolib>

see also

<http://www.agilent.com/find/vee>

The VISA User's Guide information on LAN programming may also be useful, see:

<ftp://ftp.agilent.com/pub/mpusup/pc/binfiles/iop/index.html>

The following assumes a LAN connection between your computer and your instrument. This will not work for the GPIB to LAN gateway.

1. Install VISA revision G.02.02 or higher.

2. Run I/O configuration.
3. Select LAN Client from the available interface types.
4. Press Configure.
5. Enter an interface name, such as lan1.
6. Enter a logical unit number, such as 7.
7. Select Okay.
8. Select VISA LAN Client from the available interface types.
9. Press Configure.
10. Enter a VISA interface name, such as GPIB1.
11. Enter the host name or IP address of your instrument in the host name field, such as aaa.companyname.com or 137.12.255.755.

NOTE

Changing the host name in your instrument does not change your LAN system representation of the host name. You must work through your local system administrator to change the host name on your LAN system and then change it to match in your instrument.

12. Enter a Remote SICL address, such as GPIB7.
13. Set the LAN interface to match the defined LAN client.
14. Select OK.
15. Close I/O Configuration by selecting OK.

Controlling Your Instrument with SICL LAN and HP/Agilent VEE

Before you can use SICL LAN with VEE, you need to set up VISA/SICL LAN I/O drivers for use with your VEE application. Consult your VEE documentation for information how to do this.

NOTE

If you are using Agilent VEE and SICL LAN, the logical unit number is limited to the range of 0-8.

The logical unit number is the same as the interface select code (ISC). VEE reserves ISC values 9-18, and does not allow you to use them for SICL/LAN communications with your instrument. VEE also does not allow any ISC values higher than 18.

After you have the VISA/SICL LAN I/O drivers installed, perform the steps below to set up VEE to control your instrument:

1. On your computer or workstation, select I/O | Instrument Manager.
2. Add a new GPIB device with an address of 7XX, where XX is the GPIB device address from your instrument.

Figure 6-1 Adding Your Instrument as a VEE Device

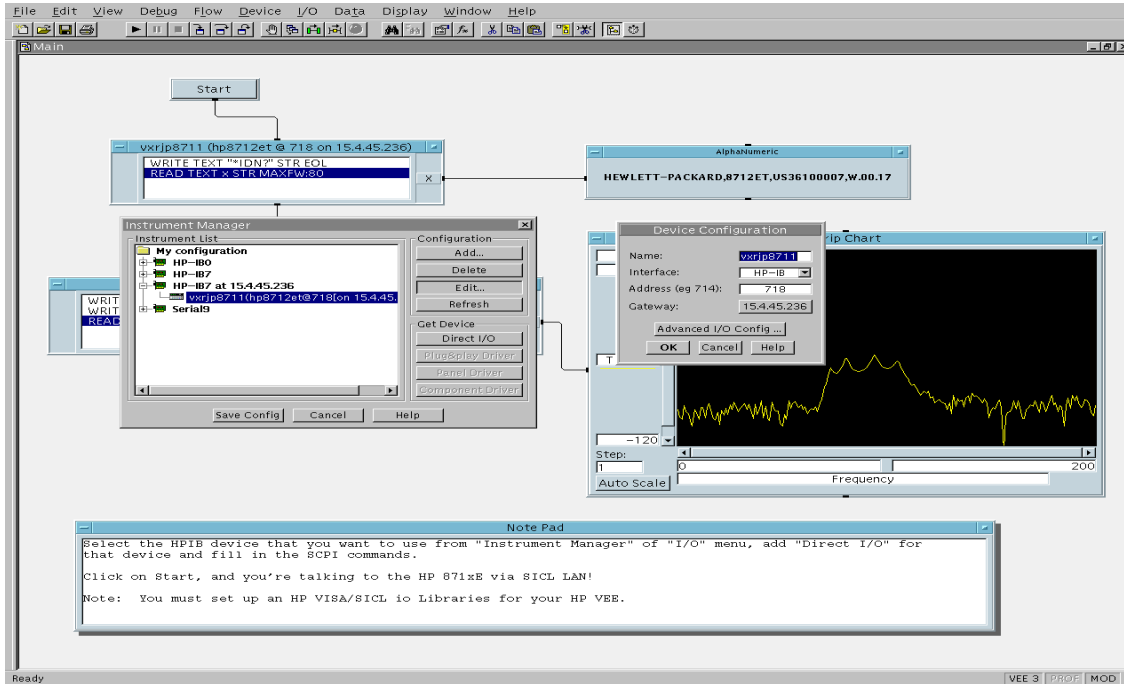

To send SCPI commands to the instrument, select I/O | Instrument Manager, and the GPIB device just added. Select Direct I/O. You can now type SCPI commands in the command window, and they are sent over the LAN to your instrument.

Controlling Your Instrument with SICL LAN and Agilent BASIC for Windows

Before you can use Agilent BASIC for Windows with SICL LAN, you need to set up VISA/SICL LAN I/O drivers for use with your BASIC applications. Consult your BASIC documentation for information how to do this.

To set up SICL LAN for BASIC, add the following statement to your AUTOST program (all on a single line):

```
LOAD BIN "GPIBS;DEV lan[analyzer IP address]:GPIB name TIME 30 ISC 7"
```

Replace analyzer IP address with the IP address of your instrument, GPIB name with the GPIB name given to your instrument, and 7 with the logical unit number.

For example, the following LOAD statement should be added to your AUTOST program for the parameters listed below:

instrument IP address **191.108.344.225**

instrument GPIB name **inst0**

logical unit number **7**

timeout value (seconds) **30**

LOAD statement (all on a single line)

```
LOAD BIN "GPIBS;DEV lan[191.108.344.225]:inst0 TIME 30 ISC 7"
```

Consult your BASIC documentation to learn how to load the SICL driver for BASIC.

After the SICL driver is loaded, you control your instrument using commands such as the following:

```
OUTPUT 718; "*IDN?"  
ENTER 718; S$
```

where 18 is the device address for the instrument.

See the BASIC example program in this chapter for more information.

Controlling Your Instrument with SICL LAN and BASIC for UNIX (Rocky Mountain BASIC)

Before you can use Rocky Mountain Basic (HPRMB) with SICL LAN, you will need to set up the SICL LAN I/O drivers for HPRMB. Consult your system administrator for details.

Create a `.rmbrc` file in your root directory of your UNIX workstation with the following entries:

```
SELECTIVE_OPEN=ON  
Interface 8= "lan[analyzer IP address]:GPIB name";NORMAL
```

Replace `analyzer IP address` with the IP address of your instrument, and `GPIB name` with the GPIB name given to your instrument. Also replace the "8" of `Interface 8` with the logical unit number. Consult your HPRMB documentation for the exact syntax.

After your SICL driver is configured correctly on your UNIX workstation, you control your instrument using commands such as the following:

```
OUTPUT 818; "*IDN?"  
ENTER 818; S$
```

where 18 is the device address for the instrument.

Using HP/Agilent VEE Over Socket LAN

(There is a VEE example program provided on the documentation CD-ROM.)

(There is a LabView example program provided on the documentation CD-ROM.)

To control your instrument via socket LAN using VEE, click on the VEE menu titled "I/O." Then select "To/From Socket" and position the I/O object box on the screen. Fill in the following fields:

```
Connect Port:    5025
Host Name:       <your_hostname>
Timeout:        15
```

For faster troubleshooting, you may want to set the timeout to a smaller number. If the host name you enter doesn't work, try using the IP address of your instrument (example: 191.108.43.5). Using the IP address rather than the hostname may also be faster. See [Figure 5](#) for an example of an VEE screen.

NOTE

Changing the host name in the instrument does not change your LAN system's representation of the host name. You must work through your local system administrator to change the host name on your LAN system.

Figure 5 Sample VEE Screen

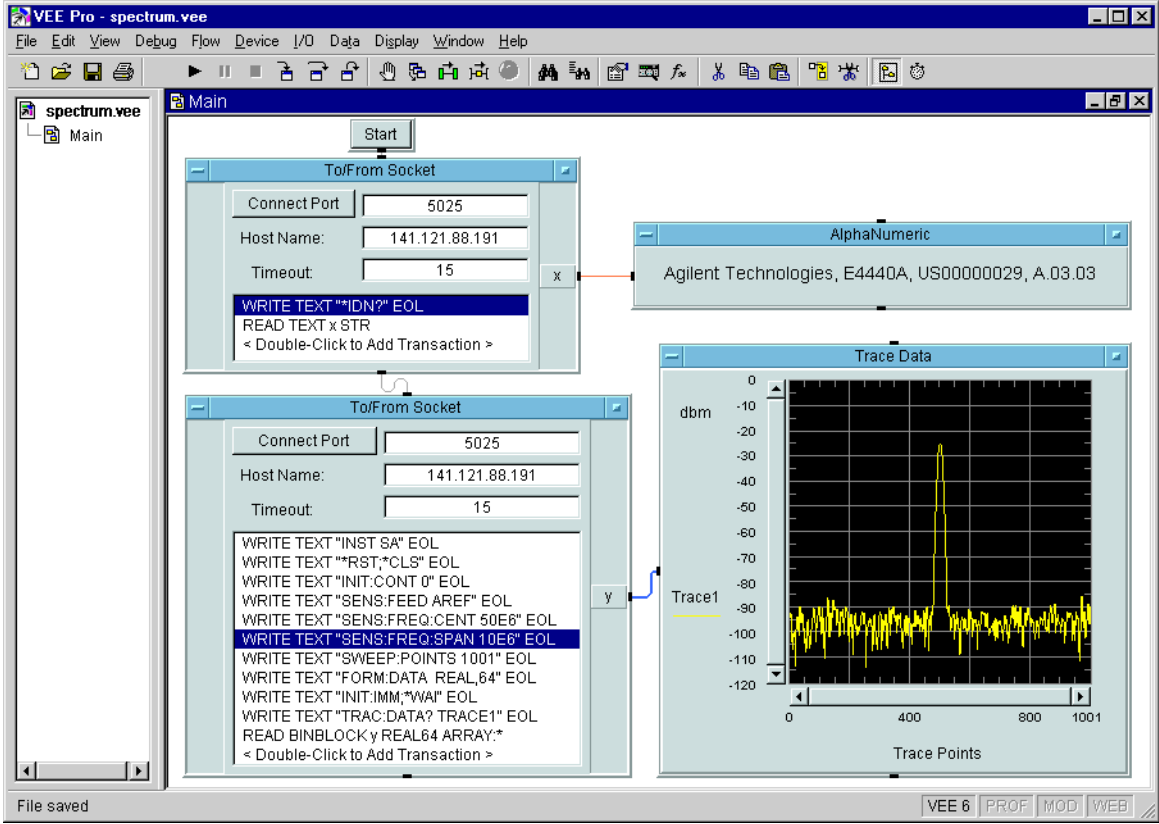

Using a Java™ Applet Over Socket LAN

There is a programming example in the *PSA Measurement Guide and Programming Examples* that demonstrates simple socket programming with Java. It is written in Java programming language, and will compile with Java compilers versions 1.0 and above.

This program is also on the documentation CD ROM that shipped with your product.

Using a C Program Over Socket LAN

The *PSA Measurement Guide and Programming Examples* book contains two examples of simple LAN socket programs. They are written in C. One compiles in the HP-UX UNIX environment and one is written for the WIN32 environment.

In UNIX, LAN communication via sockets is very similar to reading or writing a file. The only difference is the `openSocket ()` routine, which uses a few network library routines to create the TCP/IP network connection. Once this connection is created, the standard `fread ()` and `fwrite ()` routines are used for network communication.

In Windows, the routines `send ()` and `recv ()` *must* be used, because `fread ()` and `fwrite ()` may not work on sockets.

NOTE

You may need to enable the termination character attribute when using the VISA libraries for socket communication. If the `termchar` attribute is disabled, then no termination character is sent with the data and the bus will time out waiting for it. (Set `vi_attr_termchar_en`)

General LAN Troubleshooting

- [“Troubleshooting the Initial Connection” on page 6-538](#)
- [“Common Problems After a Connection is Made” on page 6-540](#)
- [“Pinging the Instrument from a Computer or Workstation” on page 6-542](#)
- [“EIA/TIA 568B Wiring Information” on page 6-544](#)

Troubleshooting the Initial Connection

Getting the instrument to work with your network often requires detailed knowledge of your local network software. This section attempts to help you with some common problems. Contact your network administrator for additional assistance.

The instrument LAN interface does not need or include any proprietary driver software. It was designed to operate with common network utilities and drivers.

Either a hardware problem or a software problem can prevent the instrument's remote file server from communicating over the LAN. The following common problems may be encountered:

Communications Not Established If you have just installed and configured the LAN interface and you have never been able to access the instrument via ftp or telnet, go directly to [“Pinging the Instrument from a Computer or Workstation” on page 6-542.](#)

If you have previously been able to access the instrument via ftp or telnet and now cannot do so, check the following:

- o Has any hardware been added or moved on your network? This includes adding or removing any workstations or peripherals, or changing any cabling.
- o Have software applications been added to the network?
- o Has the functionality been turned off from the front panel? Press **System, Config I/O, SCPI LAN.**
- o Have any configuration files been modified? Pressing **System, Restore Sys Defaults** restores the original factory defaults and you will have to re-set the instrument IP address and host name.
- o Is the upper- and lower-case character usage in your host name consistent?
- o Have any of the following files been deleted or overwritten?

UNIX:

- /etc/hosts
- /etc/inetd.conf
- /etc/services

PCs:

- dependent network files

If you know or suspect that something has changed on your network, consult with your network administrator.

Timeout Errors Timeout errors such as “Device Timeout,” “File Timeout,” and “Operation Timeout,” are symptoms of one or both of the following problems:

- The currently configured timeout limits are too short compared to the time it takes the LAN to complete some operations. This problem may occur during periods of increased LAN traffic.
- The LAN connection has failed, or fails occasionally.

To increase your timeout period, refer to your computer documentation for instructions. Contact your LAN administrator if

problems continue.

Packets Routinely Lost If packets are routinely lost, proceed to the troubleshooting section in this chapter relating to your network.

Problems Transferring or Copying Files If you have problems copying files out of or into the instrument, you might be experiencing timeout problems. See the previous section on “Timeout Errors.”

Common Problems After a Connection is Made

This section describes common problems you may encounter when using the instrument on a LAN. It assumes you have been able to connect to the instrument in the past. If this is not so, refer to the previous sections first.

NOTE

Pressing **Preset** does not affect LAN settings, but pressing **System, Restore Sys Defaults** will reset to the original factory defaults. You will then have to re-set the instrument IP address and other LAN settings in **System, Config I/O**.

NOTE

Remember that in any type of programming using LAN you should avoid constantly opening and closing connections. This uses up processing resources, adds to your system overhead, and can cause problems with asynchronous implementation of successive commands. When you are sending the instrument multiple commands: open the connection, send all the commands, and close the connection.

Cannot connect to the analyzer

- If you suspect a bad LAN connection between your computer and instrument, you can verify the network connection by using the ping command described later in this chapter or another similar echo request utility.
- If a bad connection is revealed, try the following solutions:
 - Make sure the instrument is turned on.
 - Check the physical connection to the LAN.
 - Make sure the internet (IP) Address of the instrument is set up correctly in the LAN port setup menu. (Press **System, Config I/O, IP Address**.)
 - When connecting to your instrument over a closed network (directly through a hub or crossover cable) it may help to set the instrument to its default settings for subnet mask and gateway. (subnet mask: 255.255.0.0, gateway 0.0.0.0)
 - If the instrument and the computer are on different networks or subnets, make sure the gateway address and subnet mask values

are set correctly.

Cannot access the file system via ftp

- If you get a "connection refused" message, try the following solutions:
 - If the power to the instrument was just turned on, make sure that you wait about 25 seconds before attempting the connection.
- If you get a "connection timed out" message
 - Verify the LAN connection between your computer and the instrument. Refer to "If you cannot connect to the instrument" earlier in this section.

Cannot telnet to the command parser port

- For a "connection refused" message
 - Check the telnet port number from the front panel keys.
- For a "connection timed out" or "no response from host" message
 - Verify the LAN connection between your computer and the instrument. Refer to "If you cannot connect to the instrument" earlier in this section.
- For a "connection refused" or "no response from host" message
 - If the instrument was just turned on, make sure that you wait about 25 seconds before attempting the connection.

An "operation timed-out" message

- Check the LAN connection between the computer and the instrument. Refer to "If you cannot connect to the instrument" in this section.
- Increase the file time-out value on your PC or workstation.

Cannot access internal web pages or import graphic images when using a point-to-point connection

- Disable the use of proxy servers. You may have to specify this in a number of locations, depending on the operating system and software you are using.
- Disable the use of cached copies of web pages to ensure that you always get a new copy of the instrument's screen image.

If all else fails

- Contact your network administrator.
- If you still cannot solve the problem, contact an Agilent Service Center for repair information.

Pinging the Instrument from a Computer or Workstation

Verify the communications link between the computer and the instrument remote file server using the ping utility.

From a UNIX workstation, type:

```
ping hostname 64 10
```

where 64 is the packet size, and 10 is the number of packets transmitted.

From a DOS or Windows environment, type:

```
ping hostname 10
```

where 10 is the number of echo requests.

Normal Response for UNIX

A normal response to the ping will be a total of 9, 10, or possibly 11 packets received with a minimal average round-trip time. The minimal average will be different from network to network. LAN traffic will cause the round-trip time to vary widely.

Because the number of packets received depends on your network traffic and integrity, the normal number might be different for your network.

Normal Response for DOS or Windows

A normal response to the ping will be a total of 9, 10, or possibly 11 packets received if 10 echo requests were specified.

Because the number of packets received depends on your network traffic and integrity, the normal number might be different for your network.

Error Messages

If error messages appear, then check the command syntax before continuing with the troubleshooting. If the syntax is correct, then resolve the error messages using your network documentation, or by consulting your network administrator.

If an unknown host error message appears, then check that the host name and IP address for your instrument are correctly entered from the front panel. Press **System, Config I/O**.

No Response No packets received indicates no response from a ping.

If there is no response, try typing in the IP address with the ping command, instead of using the host name. Check that the typed address matches the IP address assigned in the **System, Config I/O** menu, then check the other addresses in the menu.

Check that the host name and IP address are correctly entered in

the node names database.

If you are using a UNIX environment, ping each node along the route between your workstation and the instrument, starting with the your workstation. Ping each gateway, then attempt a ping of the remote file server.

If the instrument still does not respond to ping, then you should suspect a hardware problem with the instrument. To check the instrument performance, refer to "Verify the Instrument Performance" in this chapter.

Intermittent Response If you received 1 to 8 packets back, there is probably a problem with the network. Because the number of packets received depends on your network traffic and integrity, the number might be different for your network.

Use a LAN analyzer or LAN management software to monitor activity and determine where bottlenecks or other problems are occurring. The instrument will still function, but communications over the LAN will be slower.

On a single-client/single-server network, the most likely cause of intermittent response to an echo request is a hardware problem with the LAN module installed in the PC, the cable, or the instrument. To check the instrument, refer to "Verify the Instrument Performance" later in this chapter.

The Standard UNIX PING Command Synopsis ping [-r] [-v] [-o] host [packetsize] [count]

Description The ping command sends an echo request packet to the host once per second. Each echo response packet that is returned is listed on the screen, along with the round-trip time of the echo request and echo response.

Options and Parameters -r Bypasses the routing tables, and sends the request directly to the host.

-v Reports all packets that are received, including the response packets.

-o Requests information about the network paths taken by the requests and responses.

host The host name or IP address.

packetsize The size of each packet (8 bytes - 4096 bytes).

count The number of packets to send before ending ping (1-(2³¹-1)). If count is not specified, ping sends packets until interrupted.

EIA/TIA 568B Wiring Information

Table 6-3

Straight-Through Cable (Unshielded-twisted-pair (UTP) cable with RJ-45 connectors)

Standard, Straight-Through Wiring (each end)			
Signal Name	RJ-45 Pin #	Wire Color	Pair #
RX+	1	white/orange	2
RX-	2	orange	
TX+	3	white/green	3
TX-	6	green	
Not Used	4	blue	1
	5	white/blue	
	7	white/brown	4
	8	brown	

Table 6-4 Cross-Over Cable (Unshielded-twisted-pair (UTP) cable with RJ-45 connectors)

Cross-Over Wiring^a			
Connector A		Connector B	
Signal Name	RJ-45 Pin #	RJ-45 Pin #	Signal Name
RX+	1	3	TX+
RX-	2	6	TX-
TX+	3	1	RX+
TX-	6	2	RX-
Not Used	4	4	Not Used
	5	5	
	7	7	
	8	8	

a. Either end of this cable can be used at the instrument or LAN device. The connector names are a convention useful during cable construction only.

This cable can be used to cascade hubs or to make point-to-point connections without a LAN hub.

NOTE A convenient way to make a cross-over adapter is to use two RJ-45 *jacks* wired according to [Table 6-4](#), above. Standard straight-through patch cables can then be used from the instrument to the adapter, and from the adapter to other LAN devices. If you use a special-purpose adapter, you will avoid having a cross-over cable mistaken for a standard, straight-through patch cable.

NOTE Some commercially-available cross-over cables do not implement the cross-over wiring required for your instrument. Please refer to [Table 6-4](#), above, and verify all connections before using cables not made by Agilent Technologies.

Figure 6-2 Cross-Over Patch Cable Wiring (cross-over end)

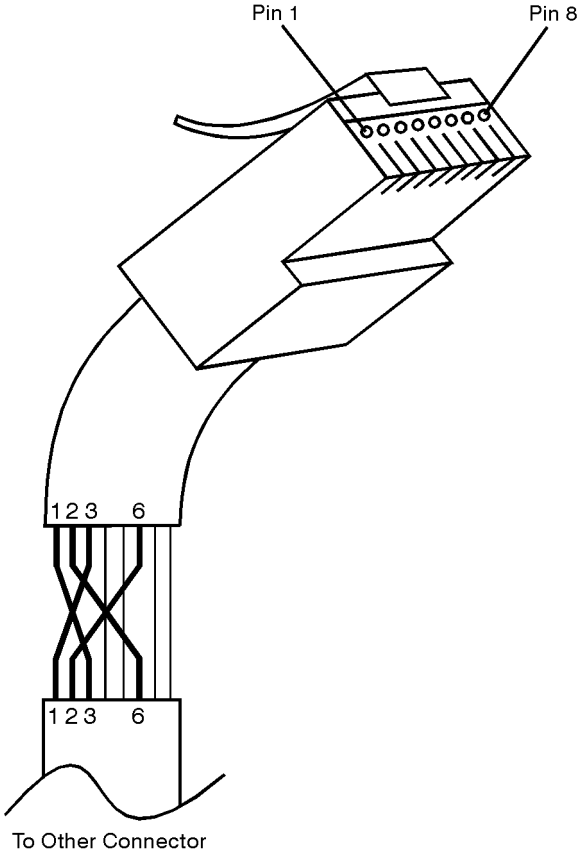

sd623c

Programming in C Using the VTL

The programming examples that are provided are written using the C programming language and the Agilent VTL (VISA transition library). This section includes some basic information about programming in the C language. Note that some of this information may not be relevant to your particular application. (For example, if you are not using VXI instruments, the VXI references will not be relevant).

Refer to your C programming language documentation for more details. (This information is taken from the manual “VISA Transition Library”, part number E2090-90026.) The following topics are included:

- “Typical Example Program Contents” on page 546
- “Linking to VTL Libraries” on page 547
- “Compiling and Linking a VTL Program” on page 547
- “Example Program” on page 549
- “Including the VISA Declarations File” on page 549
- “Opening a Session” on page 549
- “Device Sessions” on page 550
- “Addressing a Session” on page 551
- “Closing a Session” on page 553

Typical Example Program Contents

The following is a summary of the VTL function calls used in the example programs.

<code>visa.h</code>	This file is included at the beginning of the file to provide the function prototypes and constants defined by VTL.
<code>ViSession</code>	The <code>ViSession</code> is a VTL data type. Each object that will establish a communication channel must be defined as <code>ViSession</code> .
<code>viOpenDefaultRM</code>	You must first open a session with the default resource manager with the <code>viOpenDefaultRM</code> function. This function will initialize the default resource manager and return a pointer to that resource manager session.
<code>viOpen</code>	This function establishes a communication channel with the device specified. A session identifier that can be used with other VTL functions is returned. This call must be made for each device you will be using.
<code>viPrintf</code> <code>viScanf</code>	These are the VTL formatted I/O functions that are patterned after those used in the C programming

language. The `viPrintf` call sends the IEEE 488.2 *RST command to the instrument and puts it in a known state. The `viPrintf` call is used again to query for the device identification (*IDN?). The `viScanf` call is then used to read the results.

`viClose` This function must be used to close each session. When you close a device session, all data structures that had been allocated for the session will be de-allocated. When you close the default manager session, all sessions opened using the default manager session will be closed.

Linking to VTL Libraries

Your application must link to one of the VTL import libraries:

32-bit Version:

C:\VXIIPNP\WIN95\LIB\MSC\VISA32.LIB for Microsoft compilers

C:\VXIIPNP\WIN95\LIB\BC\VISA32.LIB for Borland compilers

16-bit Version:

C:\VXIIPNP\WIN\LIB\MSC\VISA.LIB for Microsoft compilers

C:\VXIIPNP\WIN\LIB\BC\VISA.LIB for Borland compilers

See the following section, “[Compiling and Linking a VTL Program](#)” for information on how to use the VTL run-time libraries.

Compiling and Linking a VTL Program

32-bit Applications

The following is a summary of important compiler-specific considerations for several C/C++ compiler products when developing WIN32 applications.

For Microsoft Visual C++ version 2.0 compilers:

- Select Project | Update All Dependencies from the menu.
- Select Project | Settings from the menu. Click on the C/C++ button. Select Code Generation from the Use Run-Time Libraries list box. VTL requires these definitions for WIN32. Click on OK to close the dialog boxes.
- Select Project | Settings from the menu. Click on the Link button and add `visa32.lib` to the Object / Library Modules list box. Optionally, you may add the library directly to your project file. Click on OK to close the dialog boxes.
- You may wish to add the include file and library file search paths.

They are set by doing the following:

1. Select `Tools | Options` from the menu.
2. Click on the `Directories` button to set the include file path.
3. Select `Include Files` from the `Show Directories For` list box.
4. Click on the `Add` button and type in the following:
`C:\VXIPNP\WIN95\INCLUDE`
5. Select `Library Files` from the `Show Directories For` list box.
6. Click on the `Add` button and type in the following:
`C:\VXIPNP\WIN95\LIB\MSC`

For Borland C++ version 4.0 compilers:

- You may wish to add the include file and library file search paths. They are set under the `Options | Project` menu selection. Double click on `Directories` from the `Topics` list box and add the following:
`C:\VXIPNP\WIN95\INCLUDE`
`C:\VXIPNP\WIN95\LIB\BC`

16-bit Applications

The following is a summary of important compiler-specific considerations for the Windows compiler.

For Microsoft Visual C++ version 1.5:

- To set the memory model, do the following:
 1. Select `Options | Project`.
 2. Click on the `Compiler` button, then select `Memory Model` from the `Category` list.
 3. Click on the `Model` list arrow to display the model options, and select `Large`.
 4. Click on `OK` to close the `Compiler` dialog box.
- You may wish to add the include file and library file search paths. They are set under the `Options | Directories` menu selection:
`C:\VXIPNP\WIN\INCLUDE`
`C:\VXIPNP\WIN\LIB\MSC`

Otherwise, the library and include files should be explicitly specified in the project file.

Example Program

This example program queries a GPIB device for an identification string and prints the results. Note that you must change the address.

```
/*idn.c - program filename */

#include "visa.h"
#include <stdio.h>

void main ()
{
    /*Open session to GPIB device at address 18 */
    ViOpenDefaultRM (&defaultRM);
    ViOpen (defaultRM, GPIB0::18::INSTR", VI_NULL,
           VI_NULL, &vi);

    /*Initialize device */
    viPrintf (vi, "*RST\n");

    /*Send an *IDN? string to the device */
    printf (vi, "*IDN?\n");

    /*Read results */
    viScanf (vi, "%t", &buf);

    /*Print results */
    printf ("Instrument identification string: %s\n", buf);

    /* Close sessions */
    viClose (vi);
    viClose (defaultRM);
}
```

Including the VISA Declarations File

For C and C++ programs, you must include the `visa.h` header file at the beginning of every file that contains VTL function calls:

```
#include "visa.h"
```

This header file contains the VISA function prototypes and the definitions for all VISA constants and error codes. The `visa.h` header file includes the `visatype.h` header file.

The `visatype.h` header file defines most of the VISA types. The VISA types are used throughout VTL to specify data types used in the functions. For example, the `viOpenDefaultRM` function requires a pointer to a parameter of type `ViSession`. If you find `ViSession` in the `visatype.h` header file, you will find that `ViSession` is eventually typed as an unsigned long.

Opening a Session

A session is a channel of communication. Sessions must first be opened

on the default resource manager, and then for each device you will be using. The following is a summary of sessions that can be opened:

- A **resource manager session** is used to initialize the VISA system. It is a parent session that knows about all the opened sessions. A resource manager session must be opened before any other session can be opened.
- A **device session** is used to communicate with a device on an interface. A device session must be opened for each device you will be using. When you use a device session you can communicate without worrying about the type of interface to which it is connected. This insulation makes applications more robust and portable across interfaces. Typically a device is an instrument, but could be a computer, a plotter, or a printer.

NOTE

All devices that you will be using need to be connected and in working condition prior to the first VTL function call (`viOpenDefaultRM`). The system is configured only on the *first* `viOpenDefaultRM` per process. Therefore, if `viOpenDefaultRM` is called without devices connected and then called again when devices are connected, the devices will not be recognized. You must close **ALL** resource manager sessions and re-open with all devices connected and in working condition.

Device Sessions

There are two parts to opening a communications session with a specific device. First you must open a session to the default resource manager with the `viOpenDefaultRM` function. The first call to this function initializes the default resource manager and returns a session to that resource manager session. You only need to open the default manager session once. However, subsequent calls to `viOpenDefaultRM` returns a session to a unique session to the same default resource manager resource.

Next, you open a session with a specific device with the `viOpen` function. This function uses the session returned from `viOpenDefaultRM` and returns its own session to identify the device session. The following shows the function syntax:

```
viOpenDefaultRM (sesn);  
viOpen (sesn, rsrcName, accessMode, timeout, vi);
```

The session returned from `viOpenDefaultRM` must be used in the `sesn` parameter of the `viOpen` function. The `viOpen` function then uses that session and the device address specified in the `rsrcName` parameter to open a device session. The `vi` parameter in `viOpen` returns a session identifier that can be used with other VTL functions.

Your program may have several sessions open at the same time by

creating multiple session identifiers by calling the `viOpen` function multiple times.

The following summarizes the parameters in the previous function calls:

<i>sesn</i>	This is a session returned from the <code>viOpenDefaultRM</code> function that identifies the resource manager session.
<i>rsrcName</i>	This is a unique symbolic name of the device (device address).
<i>accessMode</i>	This parameter is not used for VTL. Use <code>VI_NULL</code> .
<i>timeout</i>	This parameter is not used for VTL. Use <code>VI_NULL</code> .
<i>vi</i>	This is a pointer to the session identifier for this particular device session. This pointer will be used to identify this device session when using other VTL functions.

The following is an example of opening sessions with a GPIB multimeter and a GPIB-VXI scanner:

```
ViSession defaultRM, dmm, scanner;
.
.
viOpenDefaultRM(&defaultRM);
viOpen (defaultRM, "GPIB0::22::INSTR", VI_NULL,
        VI_NULL, &dmm);
viOpen (defaultRM, "GPIB-VXI0::24::INSTR", VI_NULL,
        VI_NULL, &scanner);
.
.
viClose (scanner);
viClose (dmm);
viClose (defaultRM);
```

The above function first opens a session with the default resource manager. The session returned from the resource manager and a device address is then used to open a session with the GPIB device at address 22. That session will now be identified as **dmm** when using other VTL functions. The session returned from the resource manager is then used again with another device address to open a session with the GPIB-VXI device at primary address 9 and VXI logical address 24. That session will now be identified as **scanner** when using other VTL functions. See the following section for information on addressing particular devices.

Addressing a Session

As seen in the previous section, the *rsrcName* parameter in the `viOpen` function is used to identify a specific device. This parameter is made up of the VTL interface name and the device address. The interface name is determined when you run the VTL Configuration Utility. This name

is usually the interface type followed by a number. The following table illustrates the format of the *rsrcName* for the different interface types:

Interface	Syntax
VXI	VXI [<i>board</i>]::VXI logical address[::INSTR]
GPIB-VXI	GPIB-VXI [<i>board</i>]::VXI logical address[::INSTR]
GPIB	GPIB [<i>board</i>]::primary address[::secondary address][::INSTR]

The following describes the parameters used above:

board This optional parameter is used if you have more than one interface of the same type. The default value for *board* is 0.

VXI logical address This is the logical address of the VXI instrument.

primary address This is the primary address of the GPIB device.

secondary address This optional parameter is the secondary address of the GPIB device. If no secondary address is specified, none is assumed.

INSTR This is an optional parameter that indicates that you are communicating with a resource that is of type **INSTR**, meaning instrument.

NOTE

If you want to be compatible with future releases of VTL and VISA, you must include the INSTR parameter in the syntax.

The following are examples of valid symbolic names:

XI0::24::INSTR Device at VXI logical address 24 that is of VISA type INSTR.

VXI2::128 Device at VXI logical address 128, in the third VXI system (VXI2).

GPIB-VXI0::24 A VXI device at logical address 24. This VXI device is connected via a GPIB-VXI command module.

GPIB0::7::0 A GPIB device at primary address 7 and secondary address 0 on the GPIB interface.

The following is an example of opening a device session with the GPIB device at primary address 23.

```
ViSession defaultRM, vi;
.
.
```



```
viOpenDefaultRM (&defaultRM);  
viOpen (defaultRM, "GPIB0::23::INSTR", VI_NULL,VI_NULL,&vi);  
. .  
viClose (vi);  
viClose (defaultRM);
```

Closing a Session

The `viClose` function must be used to close each session. You can close the specific device session, which will free all data structures that had been allocated for the session. If you close the default resource manager session, all sessions opened using that resource manager will be closed.

Since system resources are also used when searching for resources (`viFindRsrc`) or waiting for events (`viWaitOnEvent`), the `viClose` function needs to be called to free up find lists and event contexts.

Overview of the GPIB Bus

An instrument that is part of a GPIB network is categorized as a listener, talker, or controller, depending on its current function in the network.

Listener	A listener is a device capable of receiving data or commands from other instruments. Any number of instruments in the GPIB network can be listeners simultaneously.
Talker	A talker is a device capable of transmitting data or commands to other instruments. To avoid confusion, a GPIB system allows only one device at a time to be an active talker.
Controller	A controller is an instrument, typically a computer, capable of managing the various GPIB activities. Only one device at a time can be an active controller.

GPIB Command Statements

Command statements form the nucleus of GPIB programming. They are understood by all instruments in the network. When combined with the programming language codes, they provide all management and data communication instructions for the system. Refer to the your programming language manual and your computers I/O programming manual for more information.

The seven fundamental command functions are as follows:

- An abort function that stops all listener/talker activity on the interface bus, and prepares all instruments to receive a new command from the controller. Typically, this is an initialization command used to place the bus in a known starting condition (sometimes called: abort, abortio, reset, halt).
- A remote function that causes an instrument to change from local control to remote control. In remote control, the front panel keys are disabled except for the Local key and the line power switch (sometimes called: remote, resume).
- A local lockout function, that can be used with the remote function, to disable the front panel Local key. With the Local key disabled, only the controller (or a hard reset by the line power switch) can restore local control (sometimes called: local lockout).
- A local function that is the complement to the remote command, causing an instrument to return to local control with a fully enabled front panel (sometimes called: local, resume).

- A clear function that causes all GPIB instruments, or addressed instruments, to assume a cleared condition. The definition of clear is unique for each instrument (sometimes called: clear, reset, control, send).
- An output function that is used to send function commands and data commands from the controller to the addressed instrument (sometimes called: output, control, convert, image, iobuffer, transfer).
- An enter function that is the complement of the output function and is used to transfer data from the addressed instrument to the controller (sometimes called: enter, convert, image, iobuffer, on timeout, set timeout, transfer).

7 Using the STATUS System

When you are programming the instrument you may need to monitor instrument status to check for error conditions or monitor changes. You can determine the state of certain instrument events/conditions by programming the status register system. IEEE common commands (those beginning with *) access the higher-level summary registers. To access the information from specific registers you would use the STATUS commands.

This chapter includes:

- A list of the commands
- Instructions on using the commands
- Complete command descriptions

Status System Commands

IEEE (*) Commands	
*CAL?	Calibration Query
*CLS	Clear Status
*ESE <number>, *ESE?	Standard Event Status Enable
*ESR?	Standard Event Status Register Query
*IDN?	Identification Query
*OPC	Operation Complete Command
*OPC?	Operation Complete Query
*OPT?	Option Information Query
*RCL <register>	Recall Instrument State
*RST	Reset the Instrument
*PSC, *PSC?	Power-on Status Complete
*SAV <register>	Save Instrument State
*SRE <number>, *SRE?	Service Request Enable
*STB?	Read Status Byte Query
*TRG	Trigger a Sweep/Measurement
*TST?	Self-test Query
*WAI	Wait-to-Continue

STATus Commands	
Operation Registers	STATus:OPERation:<keyword>
	Operation Condition Query
	Operation Enable
	Operation Event Query
	Operation Negative Transition
	Operation Positive Transition
Preset the Status Bytes	STATus:PRESet
Status Registers	STATus:QUESTionable:<keyword>

Using the STATUS System
Status System Commands

STATUS Commands	
	Questionable Condition
	Questionable Enable
	Questionable Event Query
	Questionable Negative Transition
	Questionable Positive Transition
Calibration Registers	STATUS:QUESTIONABLE:CALIBRATION:<keyword>
	Questionable Calibration Condition
	Questionable Calibration Enable
	Questionable Calibration Event Query
	Questionable Calibration Negative Transition
	Questionable Calibration Positive Transition
Frequency Registers	STATUS:QUESTIONABLE:FREQUENCY:<keyword>
	Questionable Frequency Condition
	Questionable Integrity Enable
	Questionable Frequency Event Query
	Questionable Frequency Negative Transition
	Questionable Frequency Positive Transition
Integrity Registers	STATUS:QUESTIONABLE:INTEGRITY:<keyword>
	Questionable Integrity Condition
	Questionable Integrity Event Query
	Questionable Integrity Event Query
	Questionable Integrity Negative Transition
	Questionable Integrity Positive Transition
Signal Integrity Registers	STATUS:QUESTIONABLE:INTEGRITY:SIGNAL:<keyword>
	Questionable Integrity Signal Condition
	Questionable Integrity Signal Enable
	Questionable Integrity Signal Event Query
	Questionable Integrity Signal Negative Transition
	Questionable Integrity Signal Positive Transition
Calibration Integrity Registers	STATUS:QUESTIONABLE:INTEGRITY:UNCALIBRATED:<keyword>

STATus Commands	
	Questionable Calibration Integrity Condition
	Questionable Calibration Integrity Enable
	Questionable Calibration Integrity Event Query
	Questionable Calibration Integrity Negative Transition
	Questionable Calibration Integrity Positive Transition
Power Registers	STATus:QUESTionable:POWer:<keyword>
	Questionable Power Condition
	Questionable Power Enable
	Questionable Power Event Query
	Questionable Power Negative Transition
	Questionable Power Positive Transition
Temperature Registers	STATus:QUESTionable:TEMPerature:<keyword>
	Questionable Temperature Condition
	Questionable Temperature Enable
	Questionable Temperature Event Query
	Questionable Temperature Negative Transition
	Questionable Temperature Positive Transition

Using the STATUS System
Status System Commands

Common IEEE Commands

These commands are specified in IEEE Standard 488.2-1992, *IEEE Standard Codes, Formats, Protocols and Common Commands for Use with ANSI/IEEE Std 488.1-1987*. New York, NY, 1992.

Numeric values for bit patterns can be entered using decimal or hexadecimal representations. (i.e. 0 to 32767 is equivalent to #H0 to #H7FFF) See the SCPI Basics information about using bit patterns for variable parameters.

Calibration Query

*CAL?

Performs a full alignment and returns a number indicating the success of the alignment. A zero is returned if the alignment is successful. A one is returned if any part of the alignment fails. The equivalent SCPI command is CALibrate[:ALL]?

Front Panel

Access: **System, Alignments, Align All Now**

Clear Status

*CLS

Clears the status byte. It does this by emptying the error queue and clearing all bits in all of the event registers. The status byte registers summarize the states of the other registers. It is also responsible for generating service requests.

Key Type: There is no equivalent front panel key.

Standard Event Status Enable

*ESE <number>

*ESE?

Selects the desired bits from the standard event status enable register. This register monitors I/O errors and synchronization conditions such as operation complete, request control, query error, device dependent error, execution error, command error and power on. The selected bits are OR'd to become a summary bit (bit 5) in the status byte register which can be queried.

The query returns the state of the standard event status enable

Using the STATUS System
Common IEEE Commands

register.

Key Type: There is no equivalent front panel key.

Range: Integer, 0 to 255

Standard Event Status Register Query

*ESR?

Queries and clears the standard event status event register. (This is a destructive read.)

Key Type: There is no equivalent front panel key.

Range: Integer, 0 to 255

Identification Query

*IDN?

Returns an instrument identification information. The string will contain the model number, serial number and firmware revision.

The response is organized into four fields separated by commas. The field definitions are as follows:

- Manufacturer
- Model
- Serial number
- Firmware version

For example:

Agilent Technologies,E4440A,US00000123,B.02.02 (for PSA)

Key Type: There is no equivalent front panel key.

Remarks: An @ in the firmware revision information indicates that it is proto firmware.

Front Panel

Access: **System, Show System**

Instrument State Query

*LRN?

This command is not implemented. Other commands are available for

returning the *LRN data. Use *IDN? to return the instrument model number, serial number, and firmware version. Use the *SAV/*RCL commands to save and then return the instrument state information.

Operation Complete

*OPC

*OPC?

The *OPC command sets bit 0 in the standard event status register to “1” when pending operations have finished. It does not hold off subsequent operations.

The *OPC? query stops new commands from being processed until the current processing is complete. Then it returns a “1”, and the program continues. This query can be used to synchronize events of other instruments on the external bus.

The instrument does not wait for completion of *all* processes for these commands. The processes that are monitored are identified in the STATus:OPERation register. These include:

PSA Process	STATus:OPER Register Bit	Byte Value
Calibrating	0	1
Sweeping	3	8
MEASuring (not in all modes)	4	16
Waiting for trigger	5	32

For example, if you want to verify the completion of both calibration and waiting for trigger set :STAT:OPER:ENAB 35 and monitor any changes.

Key Type: There is no equivalent front panel key.

Query Instrument Options

*OPT?

For ESA and PSA analyzers: This command is not implemented. However the information is available remotely by using SCPI commands. See :SYSTem:OPTions? in the SYSTem subsystem.

Power-On Status Clear

*PSC

*PSC?

Sets the state of the power-on status clear flag. This command allows you to specify if the service request enable register and the event status enable register should be cleared at power up.

The query returns the contents of the power-on status clear flag.

Key Type: There is no equivalent front panel key.

Recall

*RCL <register>

This command recalls the instrument state from the specified instrument memory register.

If the state being loaded has a newer firmware revision than the revision of the instrument, no state is recalled and an error is reported.

If the state being loaded has an equal firmware revision than the revision of the instrument, the state will be loaded.

If the state being loaded has an older firmware revision than the revision of the instrument, the instrument will only load the parts of the state that apply to the older revision.

Key Type: There is no equivalent front panel key.

Range: registers are an integer, 0 to 127

Remarks: See also commands :MMEMory:LOAD:STATe and :MMEMory:STORE:STATe

Example: *RCL 12

Front Panel

Access: **File, Recall State**

Reset

*RST

This command presets the instrument to a factory defined condition that is appropriate for remote programming operation. In Spectrum Analysis Mode *RST is equivalent to performing the commands

- :SYSTem:PRESet, with preset type set to MODE.
- *CLS which clears the STATUS bits and error queue

*RST does not change the mode and *only* resets the parameters for the current mode.

The :SYSTem:PRESet command is equivalent to a front panel **Preset** key.

Save

*SAV <register>

This command saves the instrument state to the specified instrument memory register.

Key Type: There is no equivalent front panel key.

Range: Registers are an integer, 0 to 127

Remarks: See also commands :MMEMory:LOAD:STATe and :MMEMory:STORe:STATe

Example: *SAV 12

Front Panel

Access: **File, Save State**

Service Request Enable

*SRE <integer>

*SRE?

This command sets the value of the service request enable register.

The query returns the value of the register.

Key Type: There is no equivalent front panel key.

Range: Integer, 0 to 255

Example: *SRE 22

Read Status Byte Query

*STB?

Returns the value of the status byte register without erasing its contents.

Key Type: There is no equivalent front panel key.

Remarks: See *CLS

Trigger

*TRG

This command triggers the instrument. Use the :TRIGger[:SEQuence]:SOURce command to select the trigger source.

If you have selected a one-button measurement and it has been paused (INITiate:PAUSE), or the CONFigure:<meas> command was used. The command causes the system to exit this “waiting” state and go to the “initiated” state. The trigger system is initiated and completes one full trigger cycle. It returns to the “waiting” state on completion of the trigger cycle. See the **MEASURE** key for more information about controlling the measurement process.

The instrument must be in the single measurement mode. If INIT:CONT ON, then the command is ignored. Depending upon the measurement and the number of averages, there may be multiple data acquisitions, with multiple trigger events, for one full trigger cycle.

Key Type: There is no equivalent front panel key.

Remarks: See also the :INITiate:IMMediate command

Front Panel

Access: **Restart**

Self Test Query

*TST?

For PSA analyzers, *NO* tests are performed. *TST? always returns 0.

Key Type: There is no equivalent front panel key.

Wait-to-Continue

*WAI

This command causes the instrument to wait until all pending commands/processes are completed before executing any additional commands. There is no query form for the command.

The instrument does not wait for completion of *all* processes. The processes that are monitored are identified in the *OPC? command description.

Key Type: There is no equivalent front panel key.

Example: INIT:CONT OFF; INIT;*WAI

Using the STATus System
Common IEEE Commands

STATus Subsystem

The STATus subsystem controls the SCPI-defined instrument-status reporting structures. Each status register has a set of five commands used for querying or masking that particular register.

Numeric values for bit patterns can be entered using decimal or hexadecimal representations. (i.e. 0 to 32767 is equivalent to #H0 to #H7FFF) See the SCPI Basics information about using bit patterns for variable parameters.

Operation Register

Operation Condition Query

:STATus:OPERation:CONDition?

This query returns the decimal value of the sum of the bits in the Status Operation Condition register.

NOTE The data in this register is continuously updated and reflects the current conditions.

Key Type: There is no equivalent front panel key.

Operation Enable

:STATus:OPERation:ENABle <integer>

:STATus:OPERation:ENABle?

This command determines which bits in the Operation Event register, will set the Operation Status Summary bit (bit 7) in the Status Byte Register. The variable <number> is the sum of the decimal values of the bits you want to enable.

NOTE The preset condition is to have all bits in this enable register set to 0. To have any Operation Events reported to the Status Byte Register, one or more bits need to be set to 1.

Key Type: There is no equivalent front panel key.

Factory Preset: 0

Range: 0 to 32767

Operation Event Query

:STATUS:OPERation[:EVENT]?

This query returns the decimal value of the sum of the bits in the Operation Event register.

NOTE

The register requires that the associated PTR or NTR filters be set before a condition register bit can set a bit in the event register.

The data in this register is latched until it is queried. Once queried, the register is cleared.

Key Type: There is no equivalent front panel key.

Operation Negative Transition

:STATUS:OPERation:NTRansition <integer>

:STATUS:OPERation:NTRansition?

This command determines which bits in the Operation Condition register will set the corresponding bit in the Operation Event register when the condition register bit has a negative transition (1 to 0). The variable <number> is the sum of the decimal values of the bits that you want to enable.

Key Type: There is no equivalent front panel key.

Factory Preset: 0

Range: 0 to 32767

Operation Positive Transition

:STATUS:OPERation:PTRansition <integer>

:STATUS:OPERation:PTRansition?

This command determines which bits in the Operation Condition register will set the corresponding bit in the Operation Event register when the condition register bit has a positive transition (0 to 1). The variable <number> is the sum of the decimal values of the bits that you want to enable.

Key Type: There is no equivalent front panel key.

Factory Preset: 32767 (all 1's)

Range: 0 to 32767

Preset the Status Byte

:STATus:PRESet

Sets bits in most of the enable and transition registers to their default state. It presets all the Transition Filters, Enable Registers, and the Error/Event Queue Enable. It has no effect on Event Registers, Error/Event QUEUE, IEEE 488.2 ESE, and SRE Registers as described in IEEE Standard 488.2-1992, *IEEE Standard Codes, Formats, Protocols and Common Commands for Use with ANSI/IEEE Std 488.1-1987*. New York, NY, 1992.

Key Type: There is no equivalent front panel key.

Questionable Register

Questionable Condition

:STATus:QUEStionable:CONDition?

This query returns the decimal value of the sum of the bits in the Questionable Condition register.

NOTE The data in this register is continuously updated and reflects the current conditions.

Key Type: There is no equivalent front panel key.

Questionable Enable

:STATus:QUEStionable:ENABle <number>

:STATus:QUEStionable:ENABle?

This command determines which bits in the Questionable Event register will set the Questionable Status Summary bit (bit3) in the Status Byte Register. The variable <number> is the sum of the decimal values of the bits you want to enable.

NOTE The preset condition is all bits in this enable register set to 0. To have any Questionable Events reported to the Status Byte Register, one or more bits need to be set to 1. The Status Byte Event Register should be queried after each measurement to check the Questionable Status Summary (bit 3). If it is equal to 1, a condition during the test may have made the test results invalid. If it is equal to 0, this indicates that no hardware problem or measurement problem was detected by the analyzer.

Using the STATUS System

STATUS Subsystem

Key Type: There is no equivalent front panel key.

Factory Preset: 0

Range: 0 to 32767

Questionable Event Query

:STATUS:QUESTIONABLE[:EVENT]?

This query returns the decimal value of the sum of the bits in the Questionable Event register.

NOTE

The register requires that the associated PTR or NTR filters be set before a condition register bit can set a bit in the event register.

The data in this register is latched until it is queried. Once queried, the register is cleared.

Key Type: There is no equivalent front panel key.

Questionable Negative Transition

:STATUS:QUESTIONABLE:NTRANSITION <number>

:STATUS:QUESTIONABLE:NTRANSITION?

This command determines which bits in the Questionable Condition register will set the corresponding bit in the Questionable Event register when the condition register bit has a negative transition (1 to 0). The variable <number> is the sum of the decimal values of the bits that you want to enable.

Key Type: There is no equivalent front panel key.

Factory Preset: 0

Range: 0 to 32767

Questionable Positive Transition

:STATUS:QUESTIONABLE:PTRANSITION <number>

:STATUS:QUESTIONABLE:PTRANSITION?

This command determines which bits in the Questionable Condition register will set the corresponding bit in the Questionable Event register when the condition register bit has a positive transition (0 to 1). The variable <number> is the sum of the decimal values of the bits that you want to enable.

Key Type: There is no equivalent front panel key.
 Factory Preset: 32767 (all 1's)
 Range: 0 to 32767

Questionable Calibration Register

Questionable Calibration Condition

:STATus:QUEStionable:CALibration:CONDition?

This query returns the decimal value of the sum of the bits in the Questionable Calibration Condition register.

NOTE The data in this register is continuously updated and reflects the current conditions.

Key Type: There is no equivalent front panel key.

Questionable Calibration Enable

:STATus:QUEStionable:CALibration:ENABle <number>

:STATus:QUEStionable:CALibration:ENABle?

This command determines which bits in the Questionable Calibration Condition Register will set bits in the Questionable Calibration Event register, which also sets the Calibration Summary bit (bit 8) in the Questionable Register. The variable <number> is the sum of the decimal values of the bits you want to enable.

Key Type: There is no equivalent front panel key.

Example STAT:QUES:CAL:ENABLE 16384 could be used if you have turned off the automatic alignment and you want to query if an alignment is needed.

Factory Preset: 32767 (all 1's)

Range: 0 to 32767

Questionable Calibration Event Query

:STATus:QUEStionable:CALibration[:EVENT]?

This query returns the decimal value of the sum of the bits in the Questionable Calibration Event register.

NOTE The register requires that the associated PTR or NTR filters be set before a condition register bit can set a bit in the event register.

 The data in this register is latched until it is queried. Once queried, the register is cleared.

Key Type: There is no equivalent front panel key.

Questionable Calibration Negative Transition

:STATus:QUEStionable:CALibration:NTRansition <number>

:STATus:QUEStionable:CALibration:NTRansition?

This command determines which bits in the Questionable Calibration Condition register will set the corresponding bit in the Questionable Calibration Event register when the condition register bit has a negative transition (1 to 0). The variable <number> is the sum of the decimal values of the bits that you want to enable.

Key Type: There is no equivalent front panel key.

Factory Preset: 0

Range: 0 to 32767

Questionable Calibration Positive Transition

:STATus:QUEStionable:CALibration:PTRansition <number>

:STATus:QUEStionable:CALibration:PTRansition?

This command determines which bits in the Questionable Calibration Condition register will set the corresponding bit in the Questionable Calibration Event register when the condition register bit has a positive transition (0 to 1). The variable <number> is the sum of the decimal values of the bits that you want to enable.

Key Type: There is no equivalent front panel key.

Factory Preset: 32767 (all 1's)

Range: 0 to 32767

Questionable Frequency Register

Questionable Frequency Condition

:STATus:QUEStionable:FREQuency:CONDition?

This query returns the decimal value of the sum of the bits in the Questionable Frequency Condition register.

NOTE The data in this register is continuously updated and reflects the current conditions.

Key Type: There is no equivalent front panel key.

Questionable Frequency Enable

:STATus:QUEStionable:FREQuency:ENABle <number>

:STATus:QUEStionable:FREQuency:ENABle?

This command determines which bits in the Questionable Frequency Condition Register will set bits in the Questionable Frequency Event register, which also sets the Frequency Summary bit (bit 5) in the Questionable Register. The variable <number> is the sum of the decimal values of the bits you want to enable.

Key Type: There is no equivalent front panel key.

Factory Preset: 32767 (all 1's)

Range: 0 to 32767

Questionable Frequency Event Query

:STATus:QUEStionable:FREQuency[:EVENT]?

This query returns the decimal value of the sum of the bits in the Questionable Frequency Event register.

NOTE The register requires that the associated PTR or NTR filters be set before a condition register bit can set a bit in the event register.

The data in this register is latched until it is queried. Once queried, the register is cleared.

Key Type: There is no equivalent front panel key.

Questionable Frequency Negative Transition

:STATus:QUEStionable:FREQuency:NTRansition <number>

:STATus:QUEStionable:FREQuency:NTRansition?

This command determines which bits in the Questionable Frequency

Using the STATUS System

STATUS Subsystem

Condition register will set the corresponding bit in the Questionable Frequency Event register when the condition register bit has a negative transition (1 to 0). The variable <number> is the sum of the decimal values of the bits that you want to enable.

Key Type: There is no equivalent front panel key.

Factory Preset: 0

Range: 0 to 32767

Questionable Frequency Positive Transition

:STATUS:QUESTIONABLE:FREQUENCY:PTRANSITION <number>

:STATUS:QUESTIONABLE:FREQUENCY:PTRANSITION?

This command determines which bits in the Questionable Frequency Condition register will set the corresponding bit in the Questionable Frequency Event register when the condition register bit has a positive transition (0 to 1). The variable <number> is the sum of the decimal values of the bits that you want to enable.

Key Type: There is no equivalent front panel key.

Factory Preset: 32767 (all 1's)

Range: 0 to 32767

Questionable Integrity Register

Questionable Integrity Condition

:STATUS:QUESTIONABLE:INTEGRITY:CONDITION?

This query returns the decimal value of the sum of the bits in the Questionable Integrity Condition register.

NOTE

The data in this register is continuously updated and reflects the current conditions.

Key Type: There is no equivalent front panel key.

Questionable Integrity Enable

:STATUS:QUESTIONABLE:INTEGRITY:ENABLE <number>

:STATUS:QUESTIONABLE:INTEGRITY:ENABLE?

This command determines which bits in the Questionable Integrity

Condition Register will set bits in the Questionable Integrity Event register, which also sets the Integrity Summary bit (bit 9) in the Questionable Register. The variable <number> is the sum of the decimal values of the bits you want to enable.

Key Type: There is no equivalent front panel key.

Factory Preset: 32767 (all 1's)

Range: 0 to 32767

Questionable Integrity Event Query

:STATus:QUEStionable:INTEgrity[:EVENT]?

This query returns the decimal value of the sum of the bits in the Questionable Integrity Event register.

NOTE

The register requires that the associated PTR or NTR filters be set before a condition register bit can set a bit in the event register.

The data in this register is latched until it is queried. Once queried, the register is cleared.

Key Type: There is no equivalent front panel key.

Questionable Integrity Negative Transition

:STATus:QUEStionable:INTEgrity:NTRansition <number>

:STATus:QUEStionable:INTEgrity:NTRansition?

This command determines which bits in the Questionable Integrity Condition register will set the corresponding bit in the Questionable Integrity Event register when the condition register bit has a negative transition (1 to 0)

The variable <number> is the sum of the decimal values of the bits that you want to enable.

Key Type: There is no equivalent front panel key.

Factory Preset: 0

Range: 0 to 32767

Questionable Integrity Positive Transition

:STATus:QUEStionable:INTEgrity:PTRansition <number>

:STATus:QUEStionable:INTEgrity:PTRansition?

Using the STATus System

STATus Subsystem

This command determines which bits in the Questionable Integrity Condition register will set the corresponding bit in the Questionable Integrity Event register when the condition register bit has a positive transition (0 to 1). The variable <number> is the sum of the decimal values of the bits that you want to enable.

Key Type: There is no equivalent front panel key.

Factory Preset: 32767 (all 1's)

Range: 0 to 32767

Questionable Integrity Signal Register

Questionable Integrity Signal Condition

:STATus:QUEStionable:INTEgrity:SIGNal:CONDition?

This query returns the decimal value of the sum of the bits in the Questionable Integrity Signal Condition register.

NOTE

The data in this register is continuously updated and reflects the current conditions.

Key Type: There is no equivalent front panel key.

Questionable Integrity Signal Enable

:STATus:QUEStionable:INTEgrity:SIGNal:ENABle <number>

:STATus:QUEStionable:INTEgrity:SIGNal:ENABle?

This command determines which bits in the Questionable Integrity Signal Condition Register will set bits in the Questionable Integrity Signal Event register, which also sets the Integrity Summary bit (bit 9) in the Questionable Register. The variable <number> is the sum of the decimal values of the bits you want to enable.

Key Type: There is no equivalent front panel key.

Factory Preset: 32767 (all 1's)

Range: 0 to 32767

Questionable Integrity Signal Event Query

:STATus:QUEStionable:INTEgrity:SIGNal[:EVENT]?

This query returns the decimal value of the sum of the bits in the

Questionable Integrity Signal Event register.

NOTE

The register requires that the associated PTR or NTR filters be set before a condition register bit can set a bit in the event register.

The data in this register is latched until it is queried. Once queried, the register is cleared.

Key Type: There is no equivalent front panel key.

Questionable Integrity Signal Negative Transition

:STATus:QUEStionable:INTEgrity:SIGNal:NTRansition <number>

:STATus:QUEStionable:INTEgrity:SIGNal:NTRansition?

This command determines which bits in the Questionable Integrity Signal Condition register will set the corresponding bit in the Questionable Integrity Signal Event register when the condition register bit has a negative transition (1 to 0). The variable <number> is the sum of the decimal values of the bits that you want to enable.

Key Type: There is no equivalent front panel key.

Factory Preset: 0

Range: 0 to 32767

Questionable Integrity Signal Positive Transition

:STATus:QUEStionable:INTEgrity:SIGNal:PTRansition <number>

:STATus:QUEStionable:INTEgrity:SIGNal:PTRansition?

This command determines which bits in the Questionable Integrity Signal Condition register will set the corresponding bit in the Questionable Integrity Signal Event register when the condition register bit has a positive transition (0 to 1). The variable <number> is the sum of the decimal values of the bits that you want to enable.

Key Type: There is no equivalent front panel key.

Factory Preset: 32767 (all 1's)

Range: 0 to 32767

Questionable Integrity Uncalibrated Register

Questionable Integrity Uncalibrated Condition

:STATUS:QUESTIONABLE:INTEGRITY:UNCALIBRATED:CONDITION?

This query returns the decimal value of the sum of the bits in the Questionable Integrity Uncalibrated Condition register.

NOTE The data in this register is continuously updated and reflects the current conditions.

Key Type: There is no equivalent front panel key.

Questionable Integrity Uncalibrated Enable

:STATUS:QUESTIONABLE:INTEGRITY:UNCALIBRATED:ENABLE

:STATUS:QUESTIONABLE:INTEGRITY:UNCALIBRATED:ENABLE?

This command determines which bits in the Questionable Integrity Uncalibrated Condition Register will set bits in the Questionable Integrity Uncalibrated Event register, which also sets the Data Uncalibrated Summary bit (bit 3) in the Questionable Integrity Register. The variable <number> is the sum of the decimal values of the bits you want to enable.

Key Type: There is no equivalent front panel key.

Factory Preset: 32767 (all 1's)

Range: 0 to 32767

Questionable Integrity Uncalibrated Event Query

:STATUS:QUESTIONABLE:INTEGRITY:UNCALIBRATED[:EVENT]?

This query returns the decimal value of the sum of the bits in the Questionable Integrity Uncalibrated Event register.

NOTE The register requires that the associated PTR or NTR filters be set before a condition register bit can set a bit in the event register.

The data in this register is latched until it is queried. Once queried, the register is cleared.

Key Type: There is no equivalent front panel key.

Questionable Integrity Uncalibrated Negative Transition

:STATus:QUEStionable:INTEgrity:UNCalibrated:NTRansition <number>

:STATus:QUEStionable:INTEgrity:UNCalibrated:NTRansition?

This command determines which bits in the Questionable Integrity Uncalibrated Condition register will set the corresponding bit in the Questionable Integrity Uncalibrated Event register when the condition register bit has a negative transition (1 to 0). The variable <number> is the sum of the decimal values of the bits that you want to enable.

Key Type: There is no equivalent front panel key.

Factory Preset: 0

Range: 0 to 32767

Questionable Integrity Uncalibrated Positive Transition

:STATus:QUEStionable:INTEgrity:UNCalibrated:PTRansition <number>

:STATus:QUEStionable:INTEgrity:UNCalibrated:PTRansition?

This command determines which bits in the Questionable Integrity Uncalibrated Condition register will set the corresponding bit in the Questionable Integrity Uncalibrated Event register when the condition register bit has a positive transition (0 to 1). The variable <number> is the sum of the decimal values of the bits that you want to enable.

Key Type: There is no equivalent front panel key.

Factory Preset: 32767 (all 1's)

Range: 0 to 32767

Questionable Power Register

Questionable Power Condition

:STATus:QUEStionable:POWer:CONDition?

This query returns the decimal value of the sum of the bits in the Questionable Power Condition register.

NOTE

The data in this register is continuously updated and reflects the current conditions.

Key Type: There is no equivalent front panel key.

Questionable Power Enable

:STATUS:QUESTIONABLE:POWER:ENABLE <number>

:STATUS:QUESTIONABLE:POWER:ENABLE?

This command determines which bits in the Questionable Power Condition Register will set bits in the Questionable Power Event register, which also sets the Power Summary bit (bit 3) in the Questionable Register. The variable <number> is the sum of the decimal values of the bits you want to enable.

Key Type: There is no equivalent front panel key.

Factory Preset: 32767 (all 1's)

Range: 0 to 32767

Questionable Power Event Query

:STATUS:QUESTIONABLE:POWER[:EVENT]?

This query returns the decimal value of the sum of the bits in the Questionable Power Event register.

NOTE

The register requires that the associated PTR or NTR filters be set before a condition register bit can set a bit in the event register.

The data in this register is latched until it is queried. Once queried, the register is cleared.

Key Type: There is no equivalent front panel key.

Questionable Power Negative Transition

:STATUS:QUESTIONABLE:POWER:NTRANSITION <number>

:STATUS:QUESTIONABLE:POWER:NTRANSITION?

This command determines which bits in the Questionable Power Condition register will set the corresponding bit in the Questionable Power Event register when the condition register bit has a negative transition (1 to 0). The variable <number> is the sum of the decimal values of the bits that you want to enable.

Key Type: There is no equivalent front panel key.

Factory Preset: 0

Range: 0 to 32767

Questionable Power Positive Transition

:STATus:QUEStionable:POWer:PTRansition <number>

:STATus:QUEStionable:POWer:PTRansition?>

This command determines which bits in the Questionable Power Condition register will set the corresponding bit in the Questionable Power Event register when the condition register bit has a positive transition (0 to 1). The variable <number> is the sum of the decimal values of the bits that you want to enable.

Key Type: There is no equivalent front panel key.

Factory Preset: 32767 (all 1's)

Range: 0 to 32767

Questionable Temperature Register

Questionable Temperature Condition

:STATus:QUEStionable:TEMPerature:CONDition?

This query returns the decimal value of the sum of the bits in the Questionable Temperature Condition register.

NOTE

The data in this register is continuously updated and reflects the current conditions.

Key Type: There is no equivalent front panel key.

Questionable Temperature Enable

:STATus:QUEStionable:TEMPerature:ENABLE <number>

:STATus:QUEStionable:TEMPerature:ENABLE?

This command determines which bits in the Questionable Temperature Condition Register will set bits in the Questionable Temperature Event register, which also sets the Temperature Summary bit (bit 4) in the Questionable Register. The variable <number> is the sum of the decimal values of the bits you want to enable.

Key Type: There is no equivalent front panel key.

Factory Preset: 32767 (all 1's)

Range: 0 to 32767

Questionable Temperature Event Query

:STATUS:QUESTIONable:TEMPerature[:EVENTt]?

This query returns the decimal value of the sum of the bits in the Questionable Temperature Event register.

NOTE

The register requires that the associated PTR or NTR filters be set before a condition register bit can set a bit in the event register.

The data in this register is latched until it is queried. Once queried, the register is cleared

Key Type: There is no equivalent front panel key.

Questionable Temperature Negative Transition

:STATUS:QUESTIONable:TEMPerature:NTRansition <number>

:STATUS:QUESTIONable:TEMPerature:NTRansition?

This command determines which bits in the Questionable Temperature Condition register will set the corresponding bit in the Questionable Temperature Event register when the condition register bit has a negative transition (1 to 0). The variable <number> is the sum of the decimal values of the bits that you want to enable.

Key Type: There is no equivalent front panel key.

Factory Preset: 0

Range: 0 to 32767

Questionable Temperature Positive Transition

:STATUS:QUESTIONable:TEMPerature:PTRansition <number>

:STATUS:QUESTIONable:TEMPerature:PTRansition?

This command determines which bits in the Questionable Temperature Condition register will set the corresponding bit in the Questionable Temperature Event register when the condition register bit has a positive transition (0 to 1). The variable <number> is the sum of the decimal values of the bits that you want to enable.

Key Type: There is no equivalent front panel key.

Factory Preset: 32767 (all 1's)

Range: 0 to 32767

8 Menu Maps: Spectrum Analysis

This chapter provide a visual representation of the front-panel keys and their associated menu keys (Spectrum Analysis mode is selected). These menu maps are in alphabetical order by the front-panel key label or oval cross-reference label. You can locate detailed information about each key/function at the page number listed in the figure title for each menu. For one-button measurement menus see [Chapter 9](#) on [page 623](#).

Alpha Editor Keys, 1 of 2

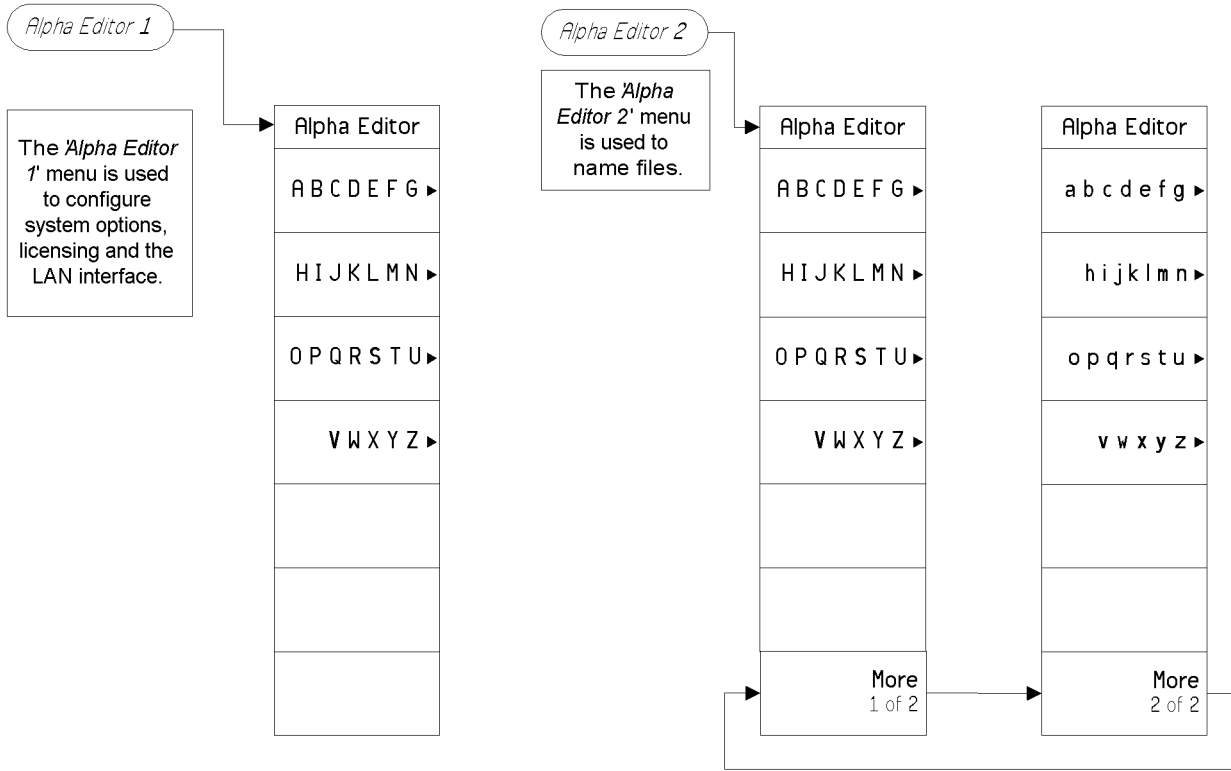

pe846a

Alpha Editor Keys, 2 of 2

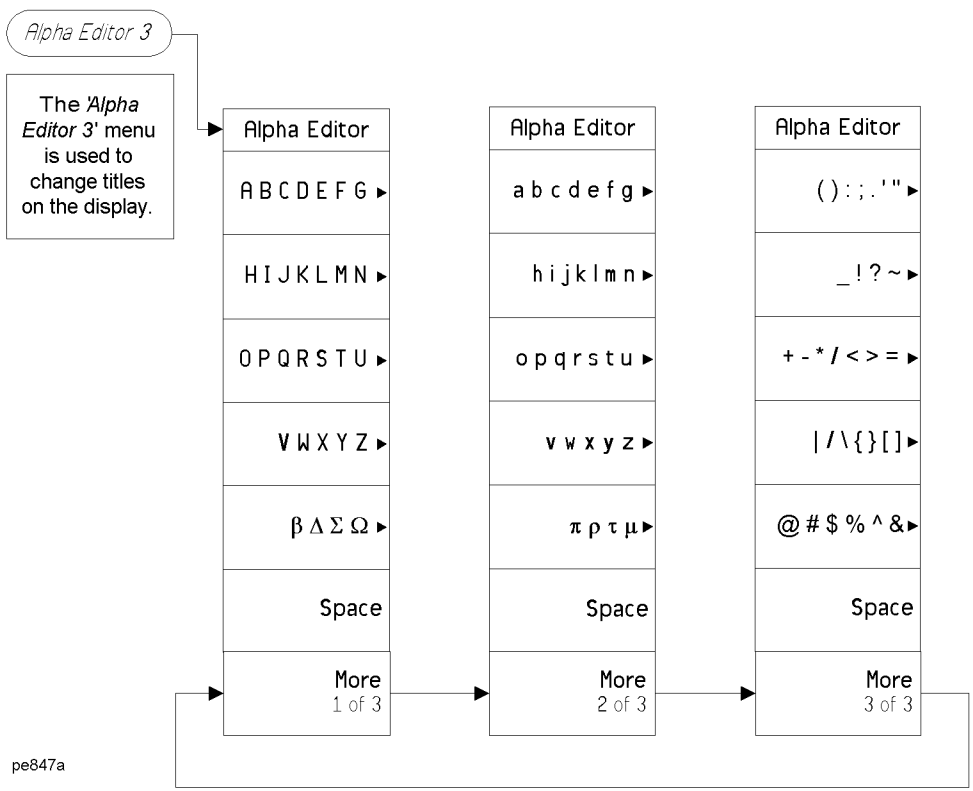

pe847a

AMPLITUDE Y Scale Key, 1 of 2 (See page 49)

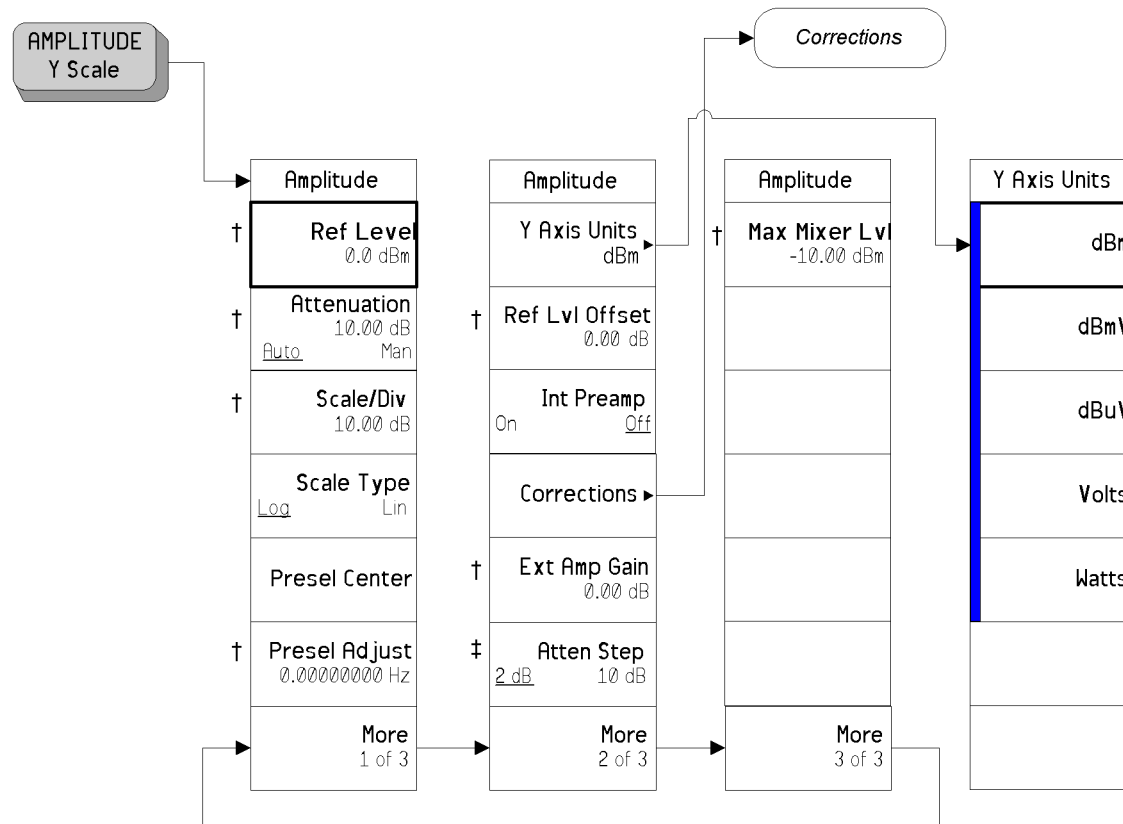

A bar on the left of two or more softkeys indicates that the keys are a set of mutually exclusive choices.

† A dagger to the left of the softkey indicates that when the key is pressed this is an active function.

‡ A double-dagger to the left of the softkey indicates a function that is not always available. It is dependent on other instrument settings.

AMPLITUDE Y Scale Key, 2 of 2 (See page 49)

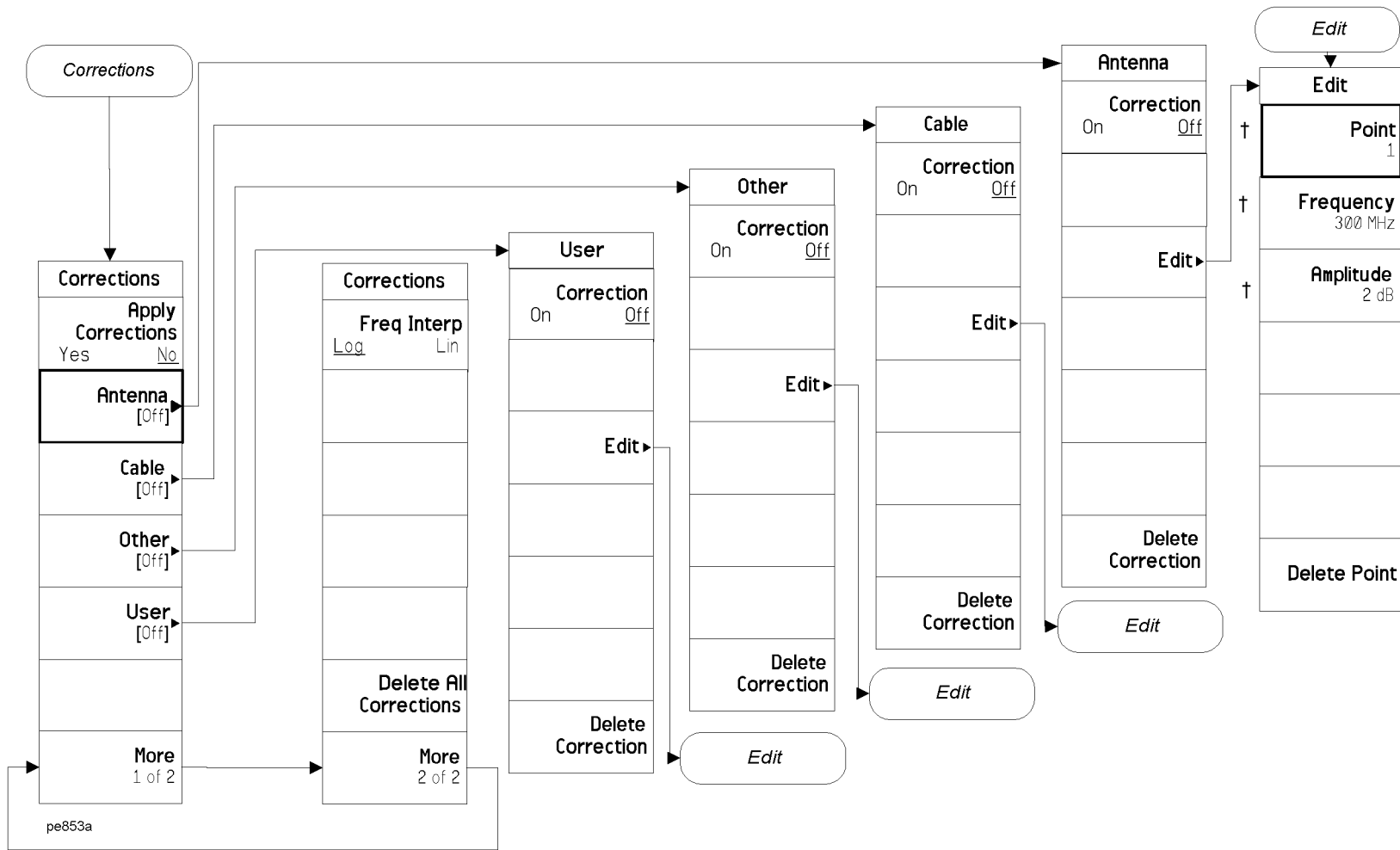

† A dagger to the left of the softkey indicates that when the key is pressed this is an active function.

Auto Couple Key, 1 of 3 (See page 71)

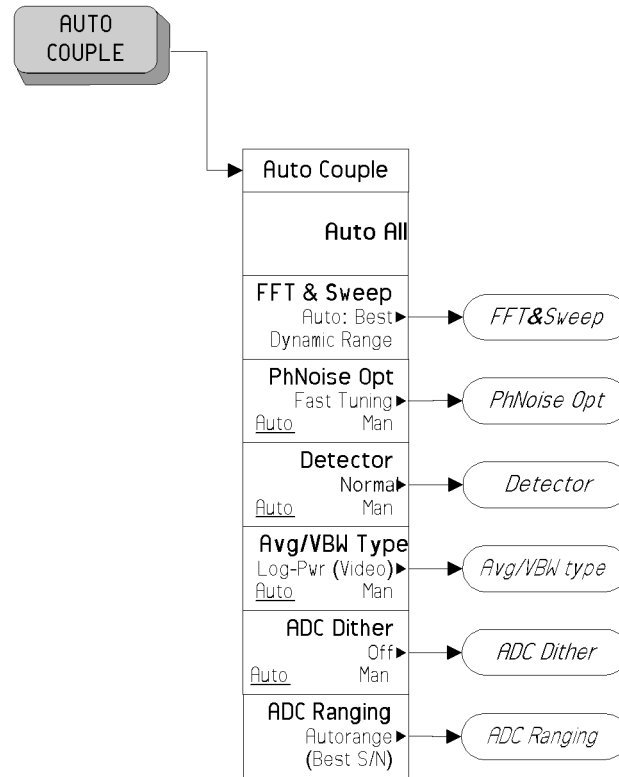

pe849a

A bar on the left of two or more softkeys indicates that the keys are a set of mutually exclusive choices.

† A dagger to the left of the softkey indicates that when the key is pressed this is an active function.

‡ A double-dagger to the left of the softkey indicates a function that is not always available. It is dependent on other instrument settings.

Auto Couple Key, 2 of 3 (See page 71)

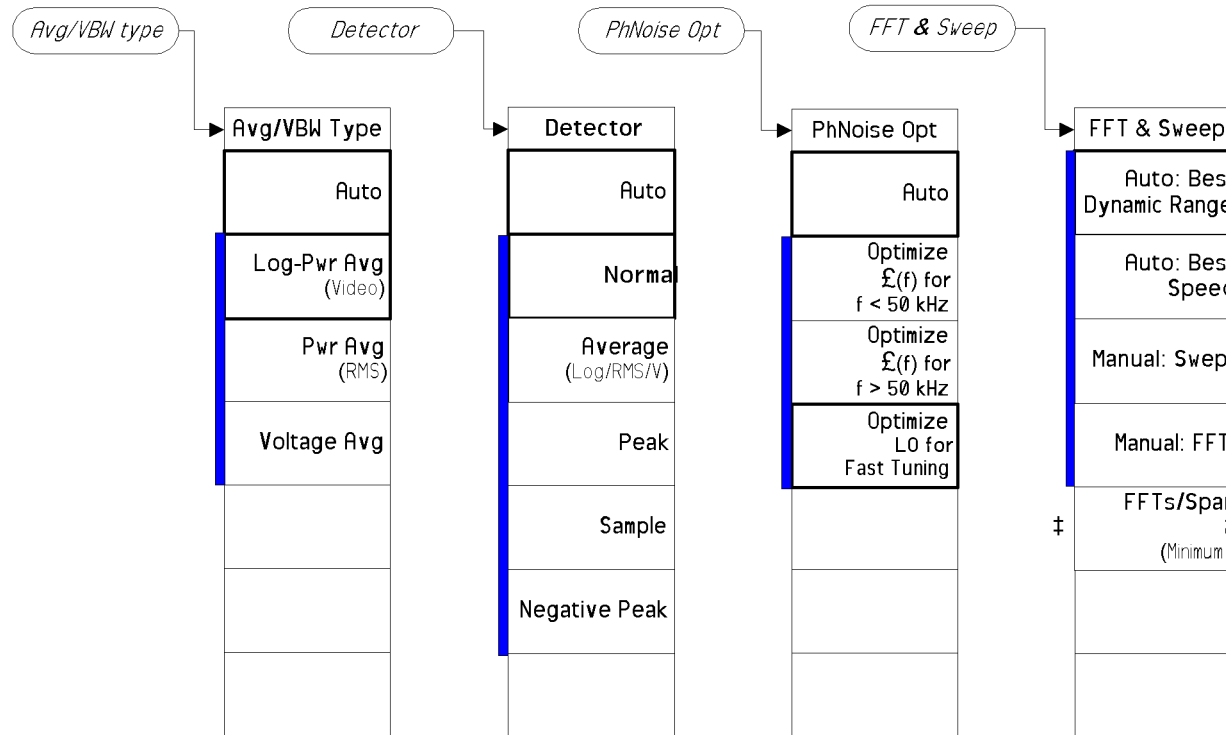

pe850a

- A bar on the left of two or more softkeys indicates that the keys are a set of mutually exclusive choices.
- ‡ A double-dagger to the left of the softkey indicates a function that is not always available. It is dependent on other instrument settings.

Auto Couple Key, 3 of 3 (See page 71)

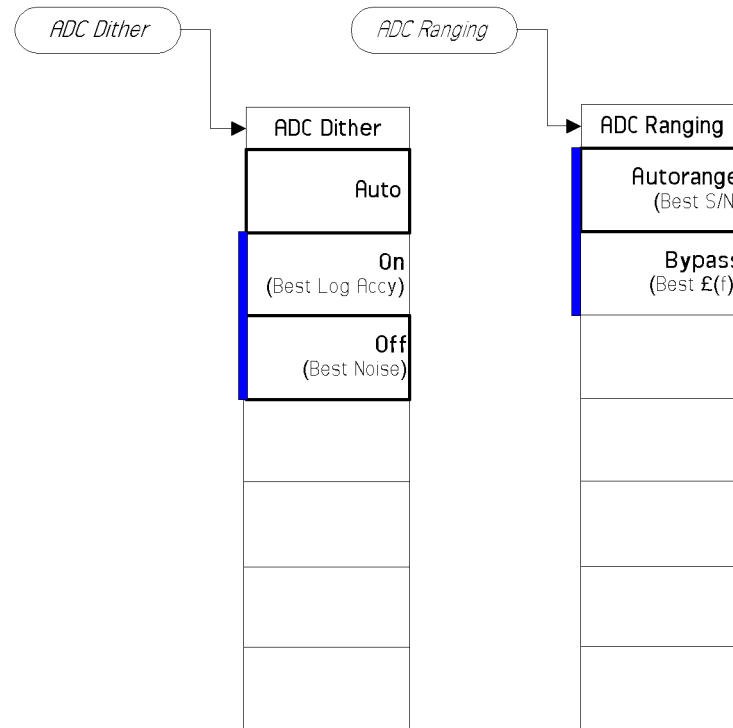

pe851a

A bar on the left of two or more softkeys indicates that the keys are a set of mutually exclusive choices.

BW/Avg Key (See page 83)

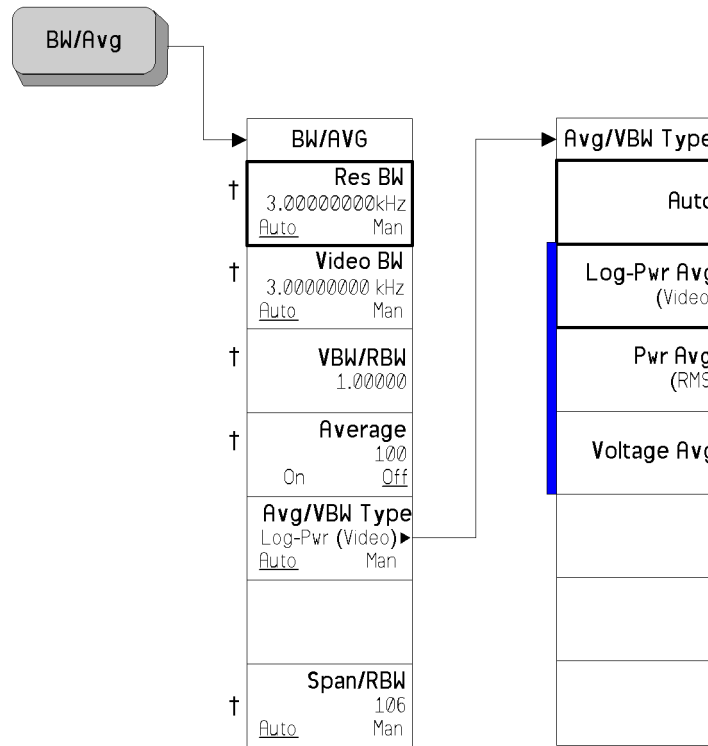

pe852a

† A bar on the left of two or more softkeys indicates that the keys are a set of mutually exclusive choices.

† A dagger to the left of the softkey indicates that when the key is pressed this is an active function.

Det/Demod Key (See page 95)

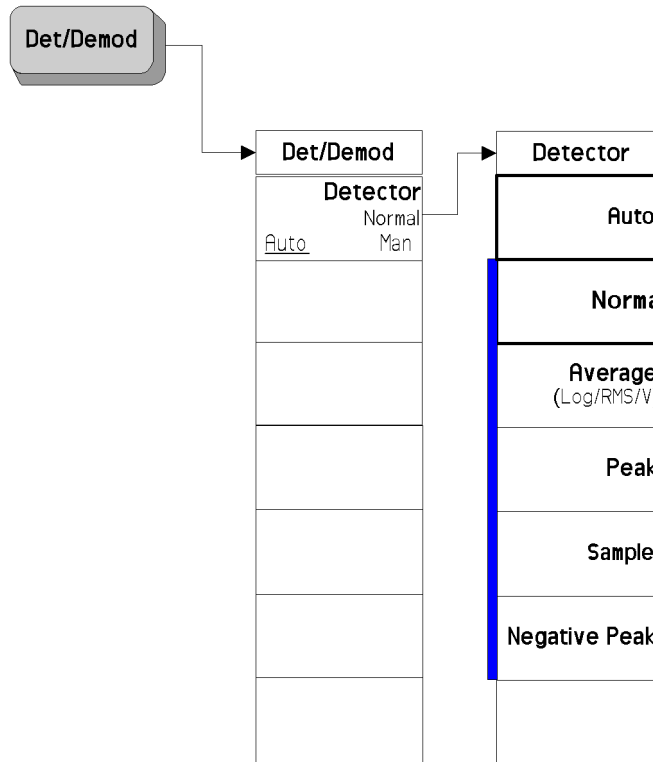

pe854a

A bar on the left of two or more softkeys indicates that the keys are a set of mutually exclusive choices.

Display Key, 1 of 2 (See page 103)

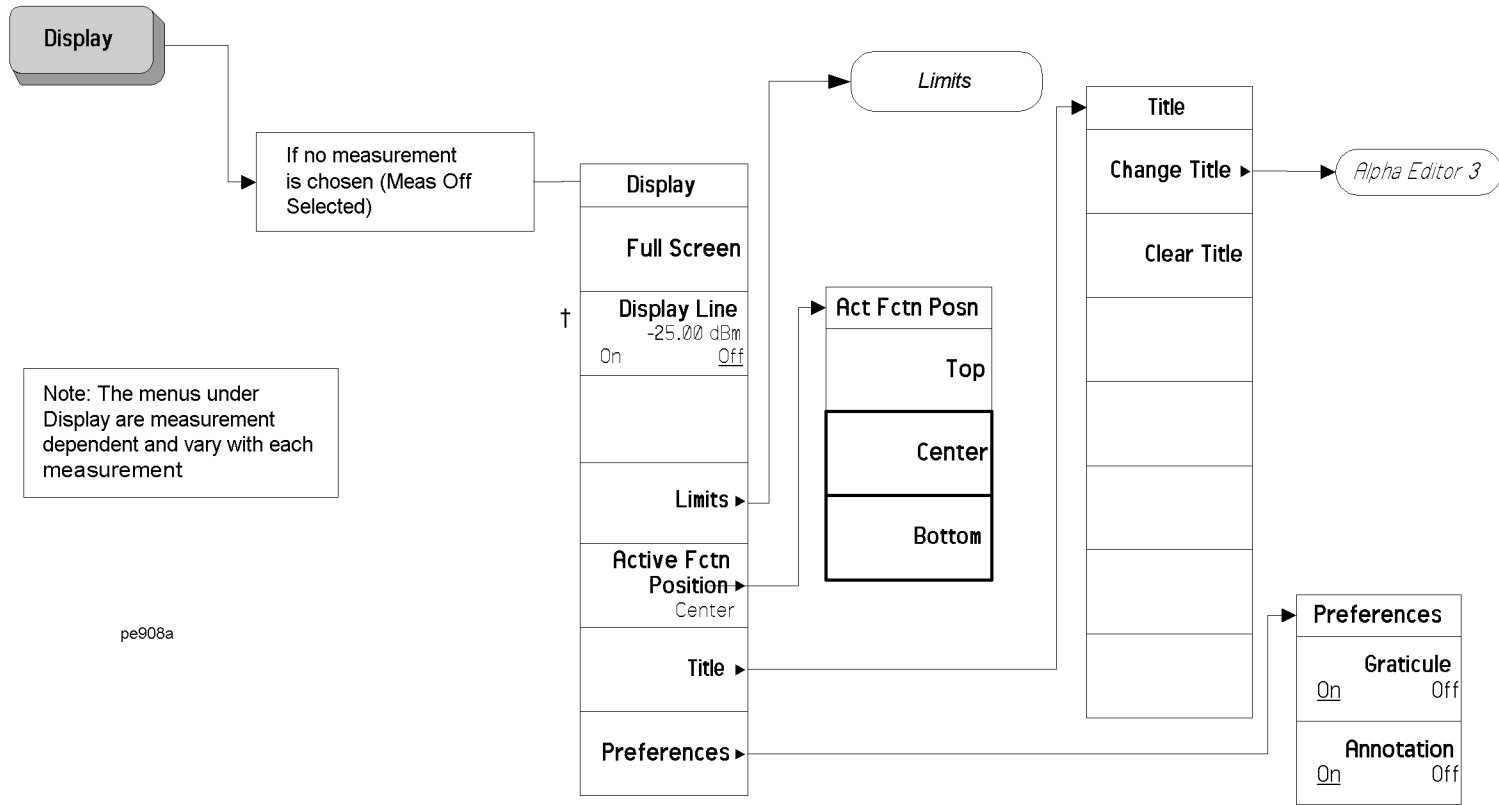

† A dagger to the left of the softkey indicates that when the key is pressed this is an active function.

Display Key, 2 of 2 (See page 103)

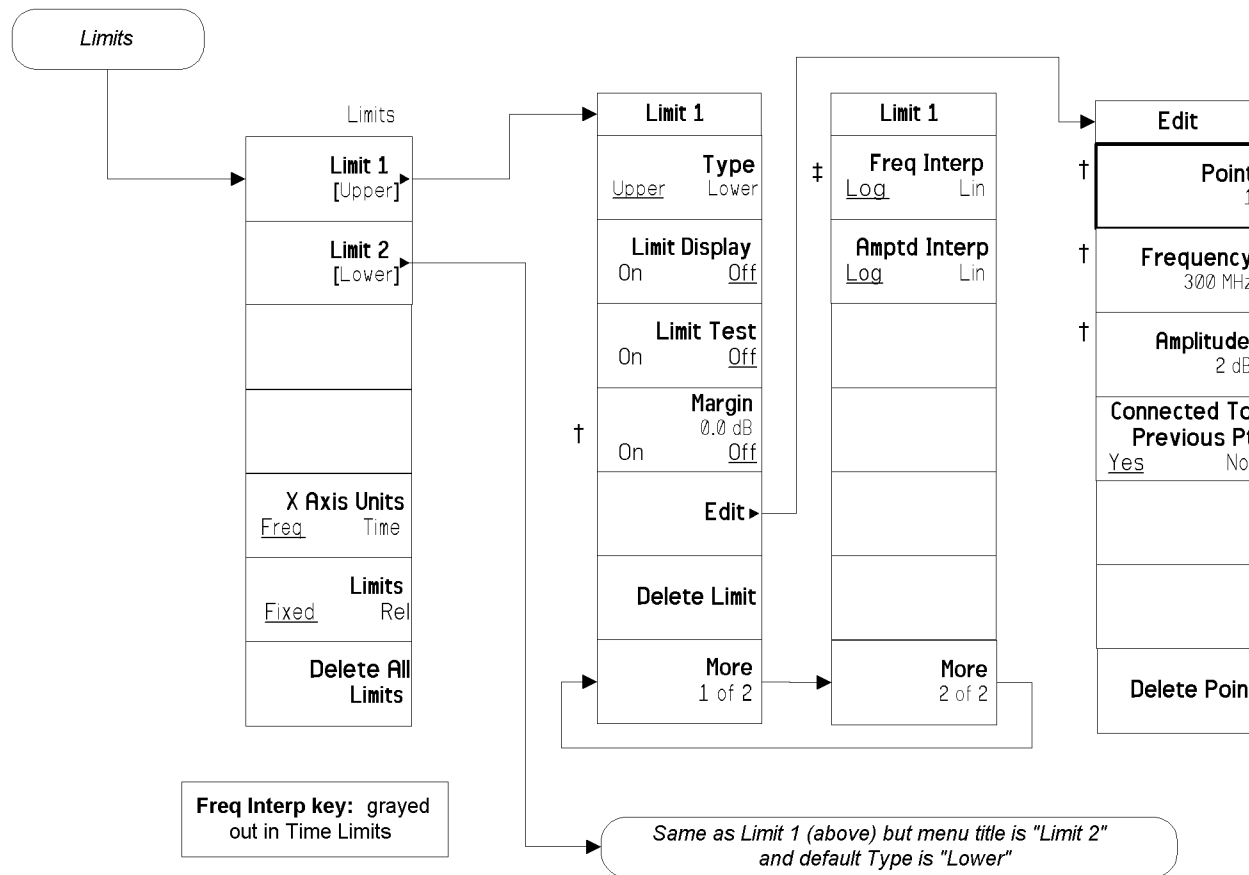

pe864a

† A dagger to the left of the softkey indicates that when the key is pressed this is an active function.

File Key, 1 of 6 (See page 127)

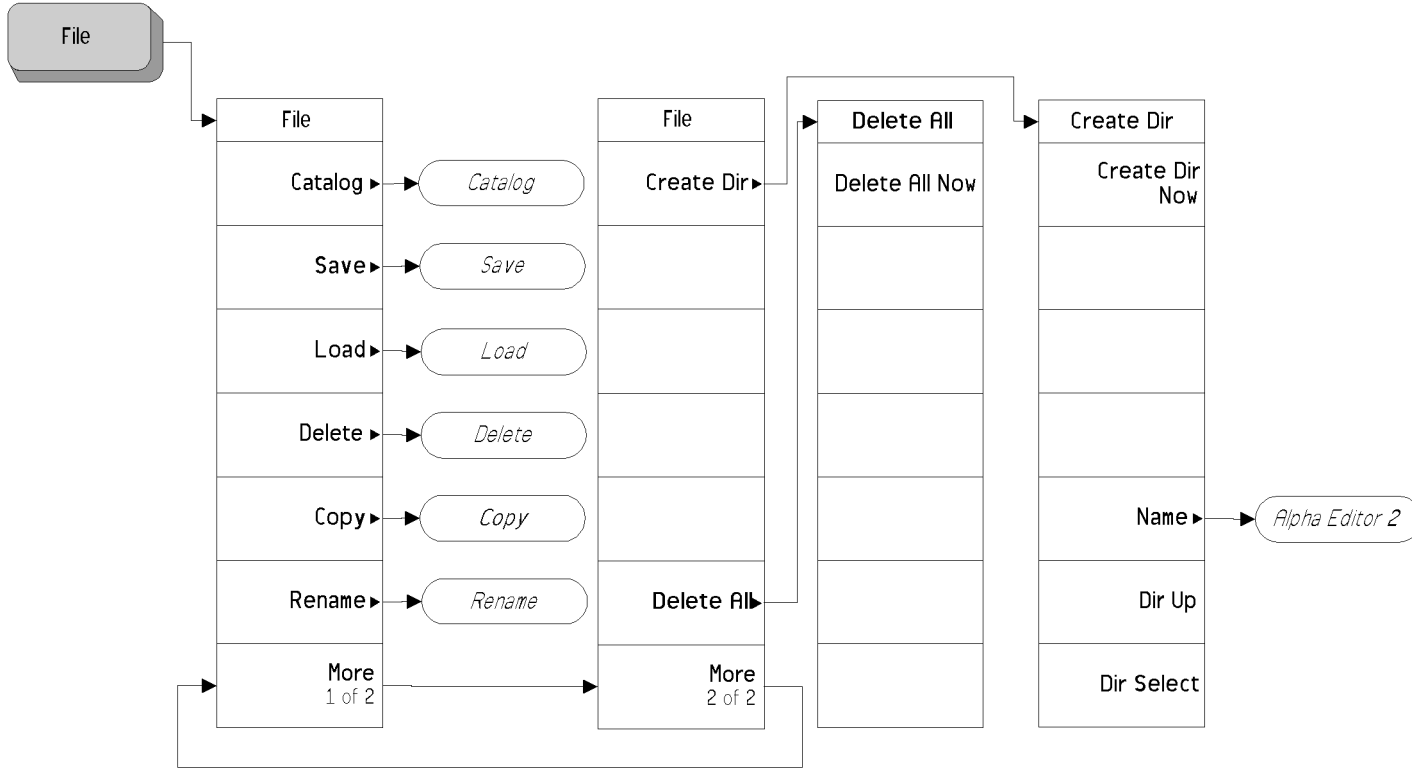

pe856a

File Key, 2 of 6 (See page 127)

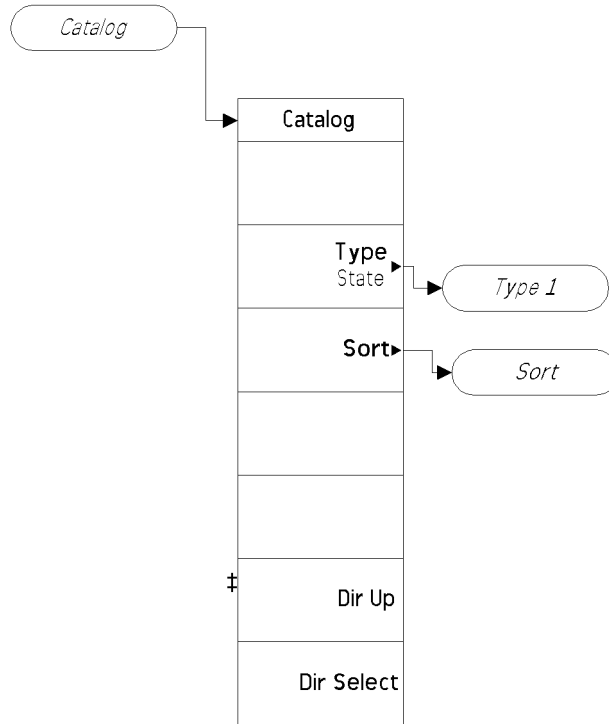

pe857a

‡ A double-dagger to the left of the softkey indicates a function that is not always available. It is dependent on other instrument settings.

File Key, 3 of 6 (See page 127)

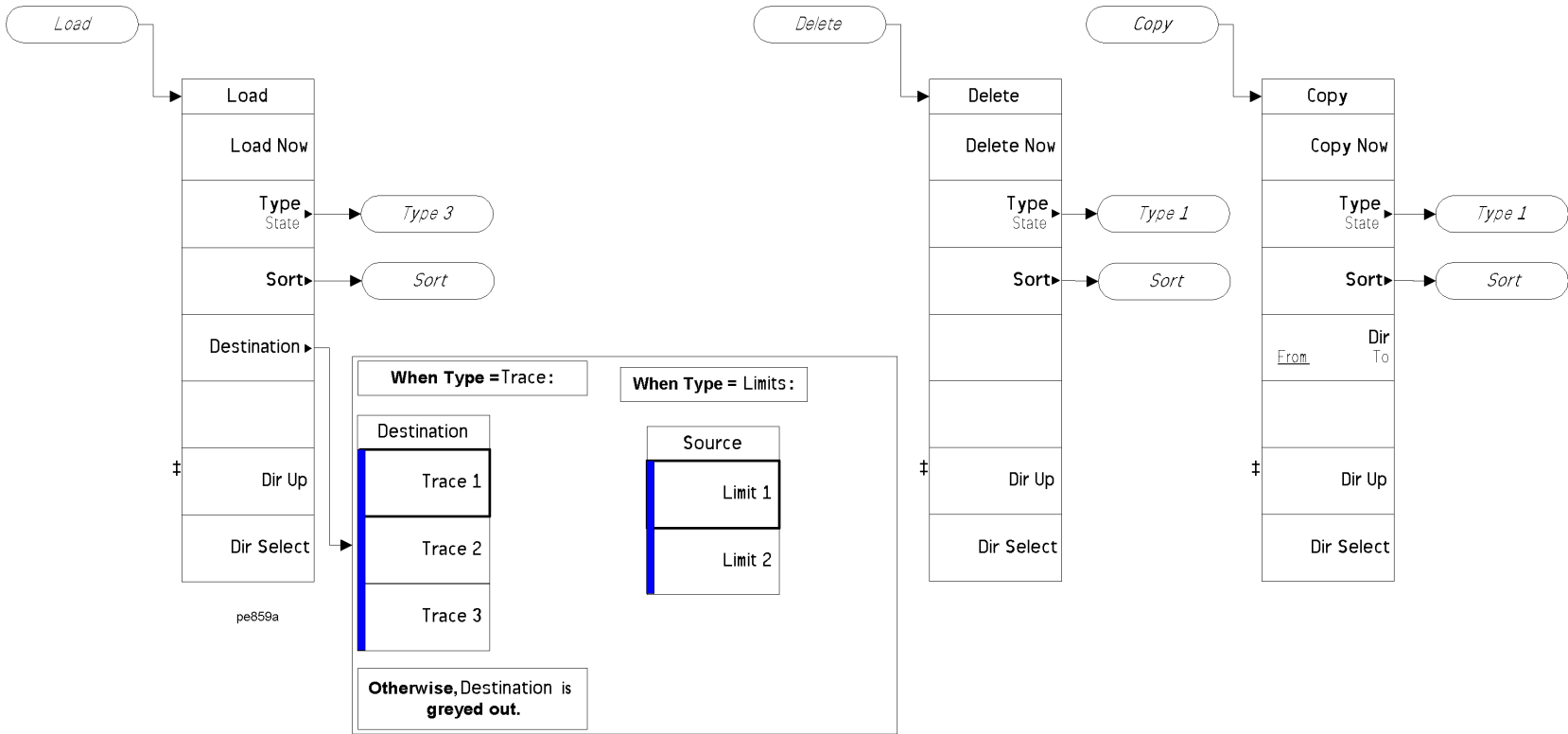

‡ A double-dagger to the left of the softkey indicates a function that is not always available. It is dependent on other instrument settings.

File Key, 4 of 6 (See page 127)

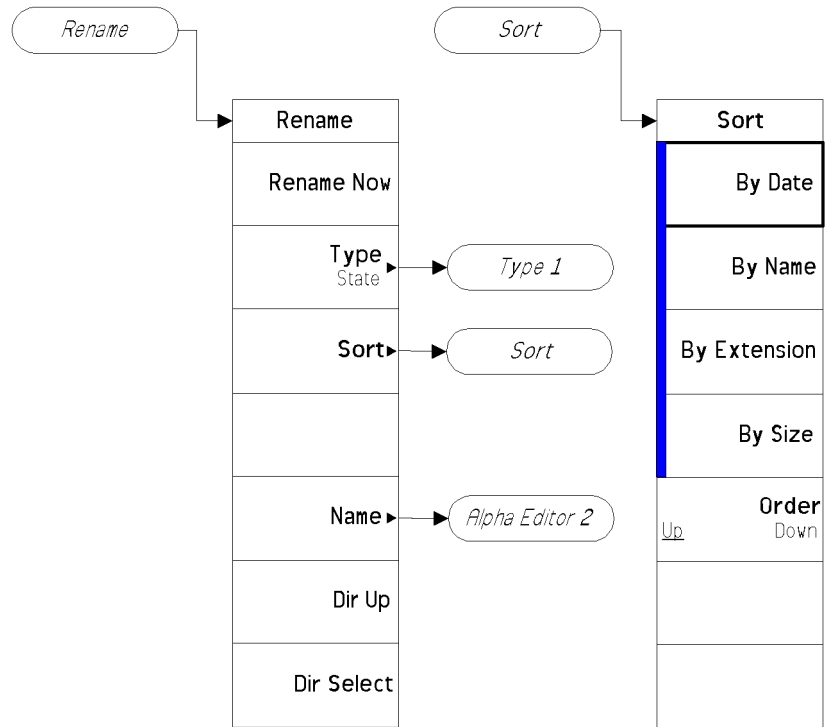

pe860a

File Key, 5 of 6 (See page 127)

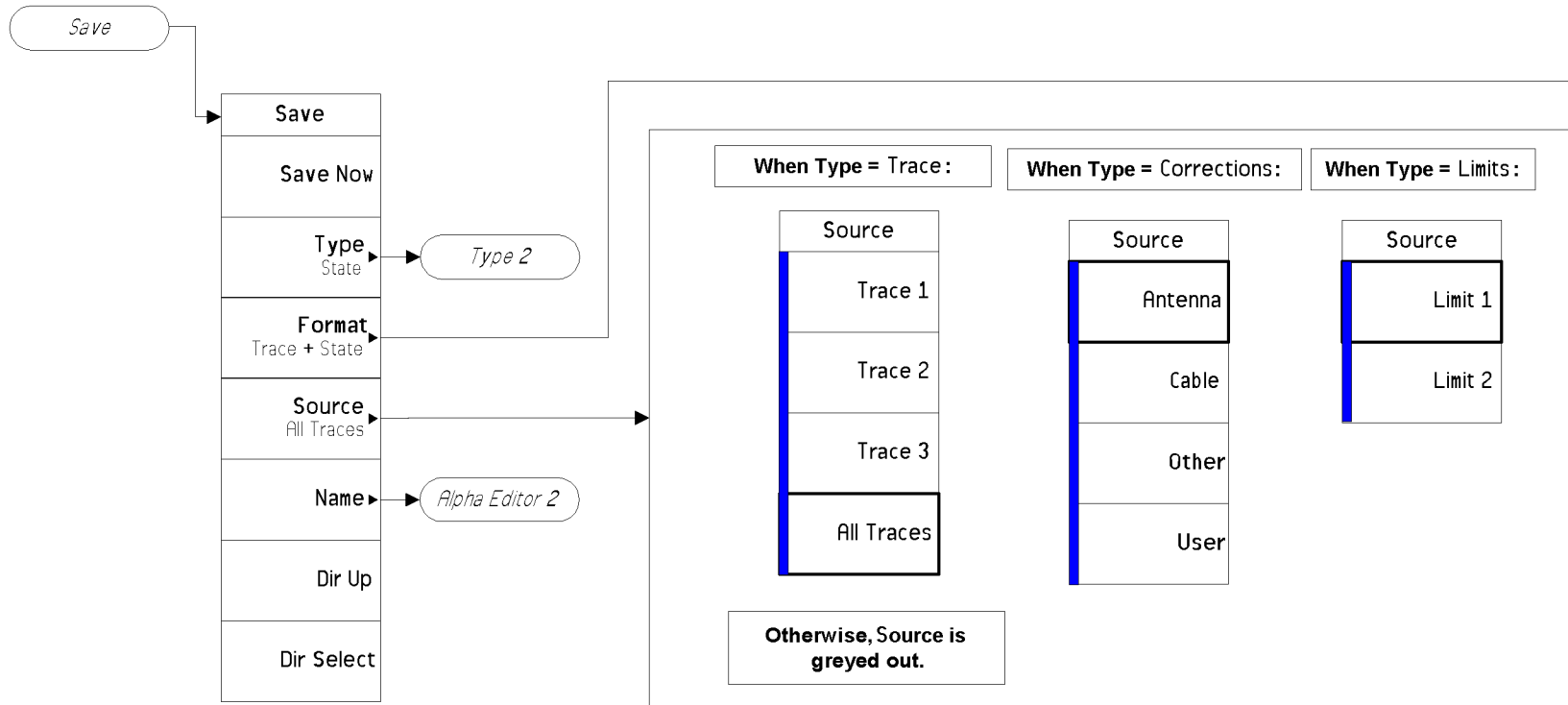

pe858a

A bar on the left of two or more softkeys indicates that the keys are a set of mutually exclusive choices.

File Key, 6 of 6 (See page 127)

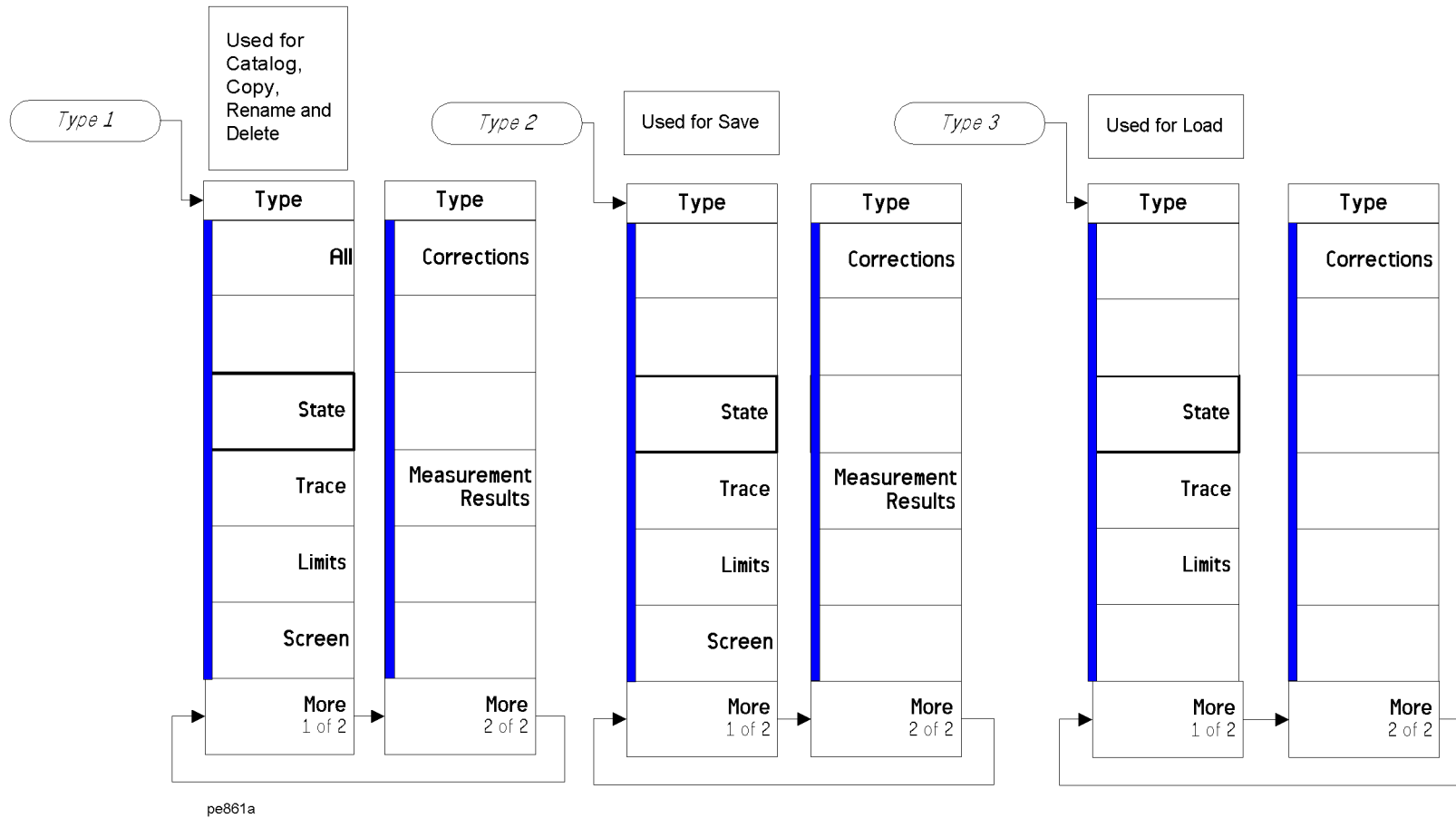

pe861a

A bar on the left of two or more softkeys indicates that the keys are a set of mutually exclusive choices.

FREQUENCY Channel Key (See page 163)

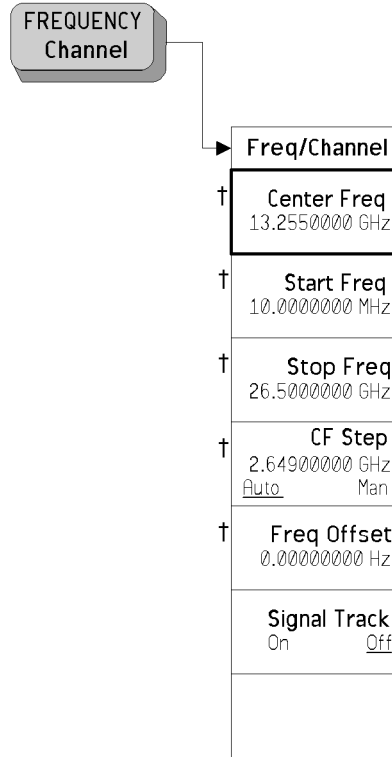

pe862a

† A dagger to the left of the softkey indicates that when the key is pressed this is an active function.

Input/Output Key (See page 171)

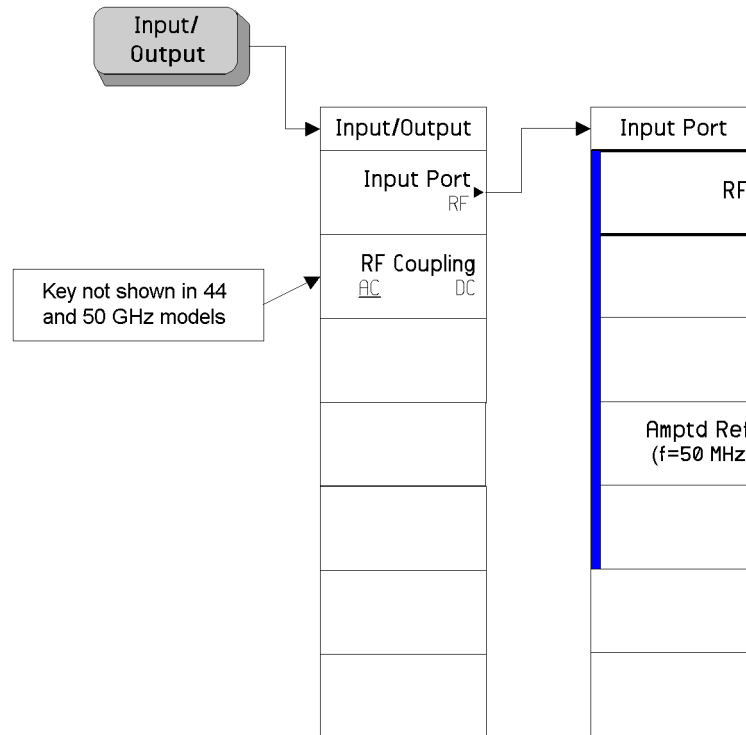

pe863a

A bar on the left of two or more softkeys indicates that the keys are a set of mutually exclusive choices.

Marker Key (See page 177)

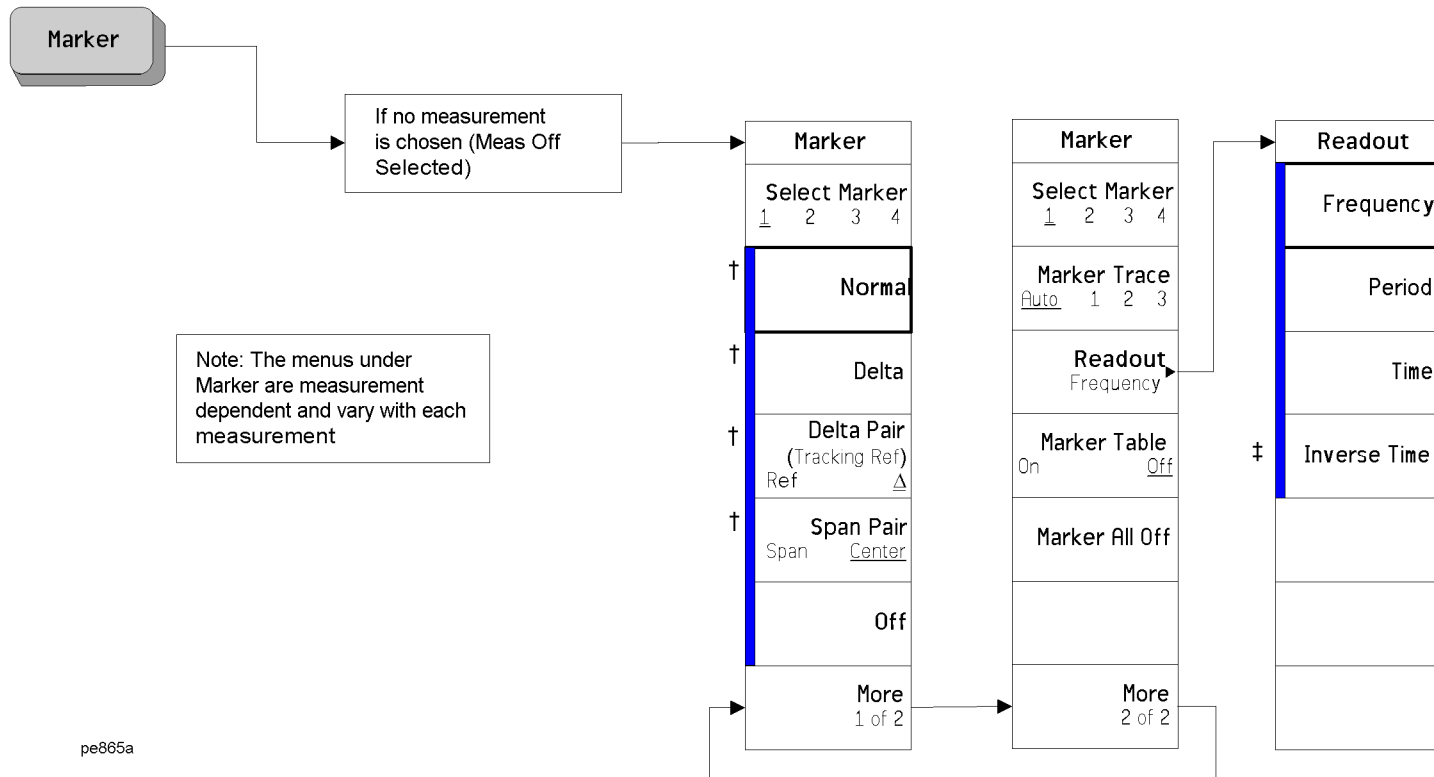

A bar on the left of two or more softkeys indicates that the keys are a set of mutually exclusive choices.

† A dagger to the left of the softkey indicates that when the key is pressed this is an active function.

‡ A double-dagger to the left of the softkey indicates a function that is not always available. It is dependent on other instrument settings.

Marker --> Key (See page 197)

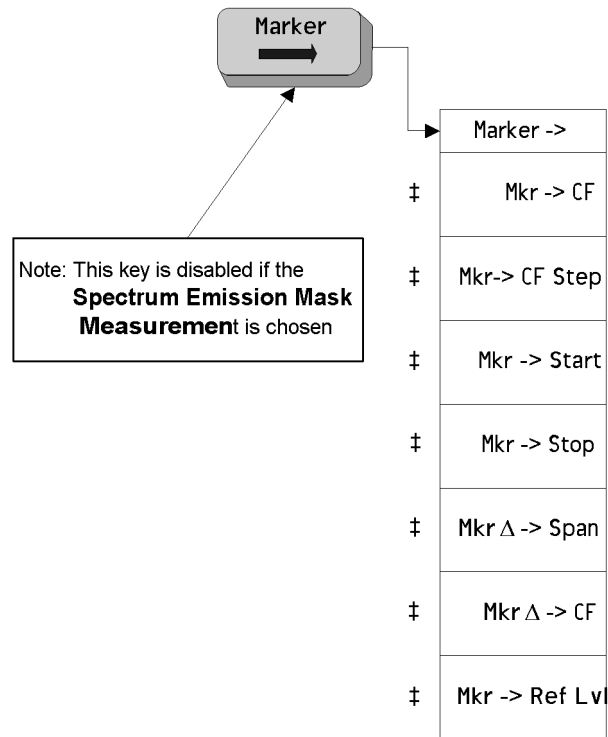

pe866a

‡ A double-dagger to the left of the softkey indicates a function that is not always available. It is dependent on other instrument settings.

Marker Fctn Key (See page 191)

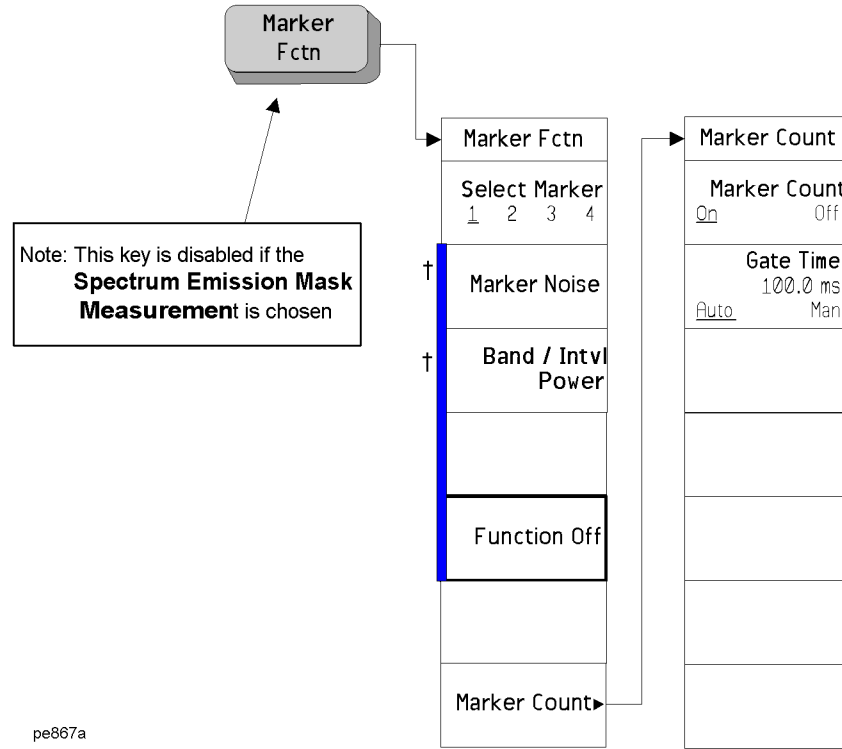

A bar on the left of two or more softkeys indicates that the keys are a set of mutually exclusive choices.

† A dagger to the left of the softkey indicates that when the key is pressed this is an active function.

MODE Key (See page 203)

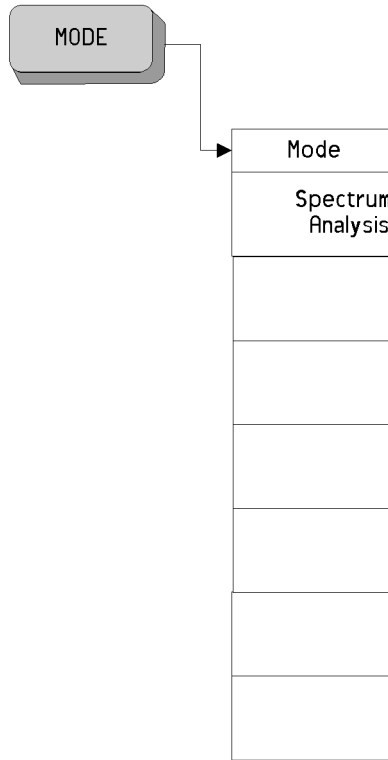

Note:when measurement applications are loaded, this menu contains a key for each loaded application. Please refer to the documentation for the specific application you are using for these menus.

pe868a

Peak Search Key (See page 209)

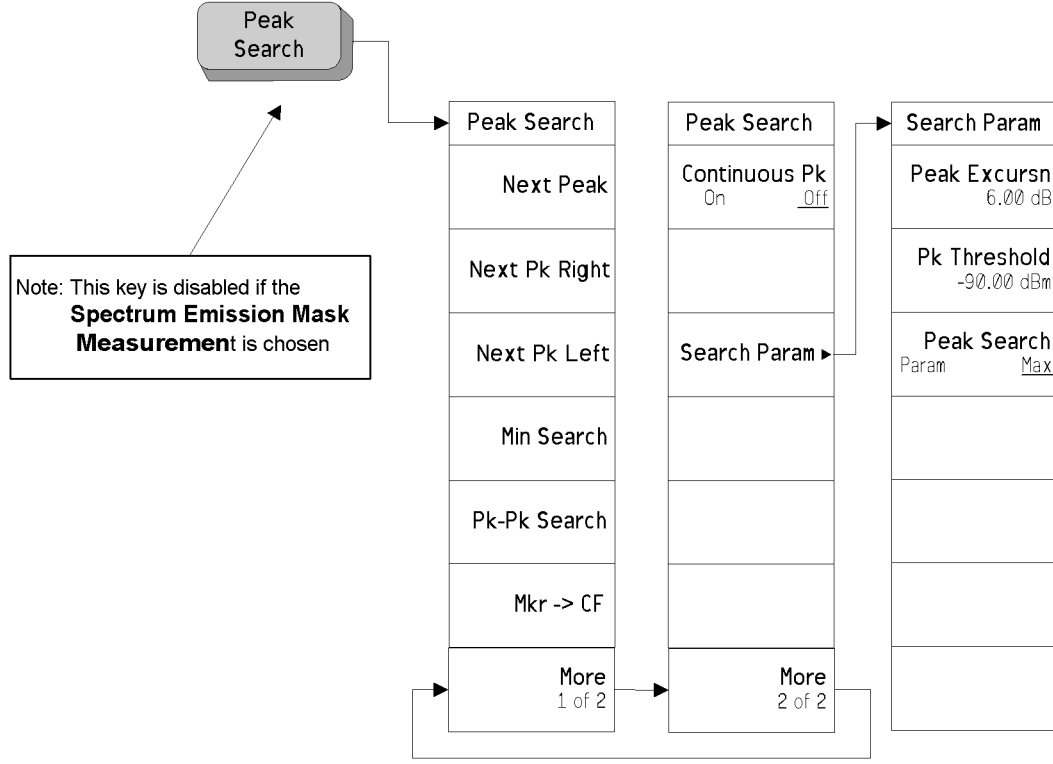

pe869a

Preset Key (See page 221)

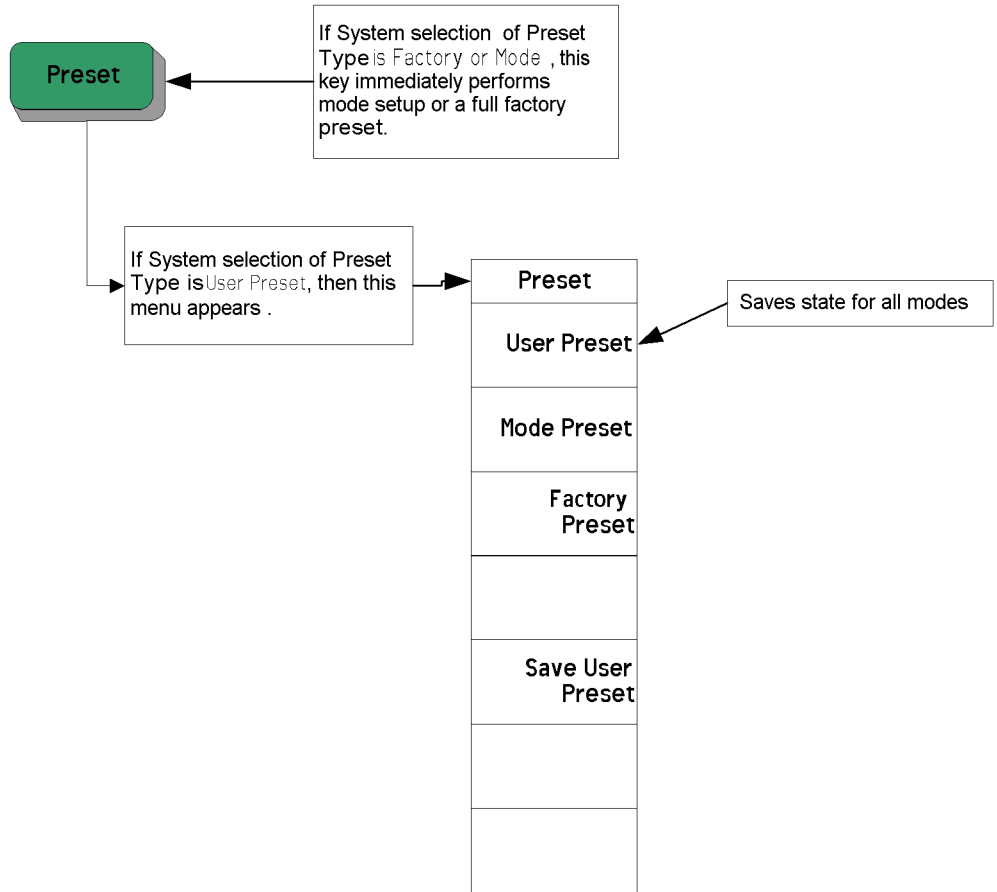

pe870a

Print Setup Key (See page 229)

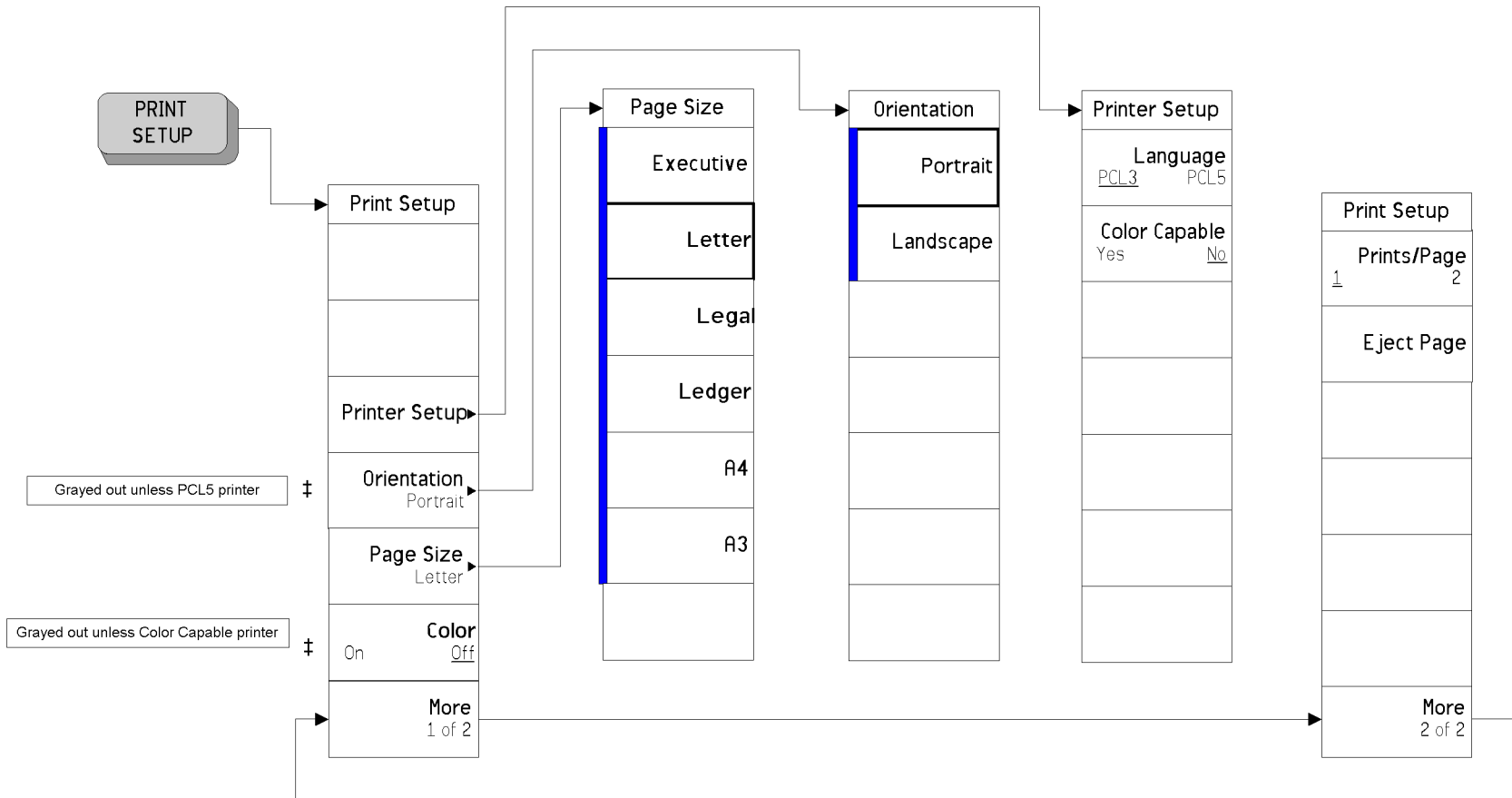

pe871a

A bar on the left of two or more softkeys indicates that the keys are a set of mutually exclusive choices.

‡ A double-dagger to the left of the softkey indicates a function that is not always available. It is dependent on other instrument settings.

SPAN X Scale Key (See page 237)

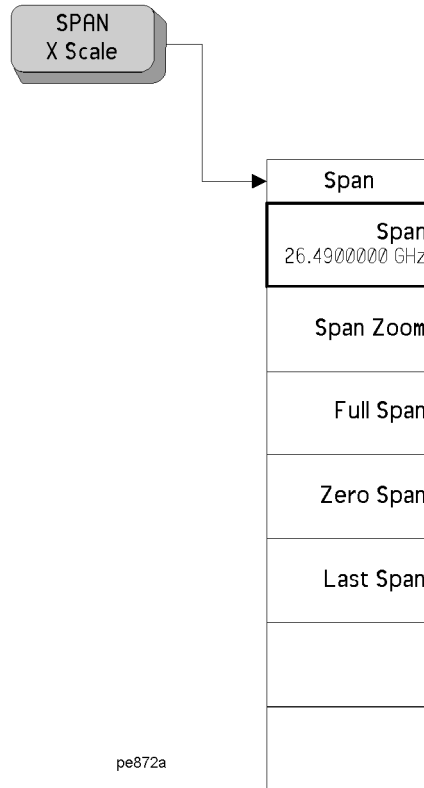

SPAN X Scale Key for CCDF Measurement (See page 389)

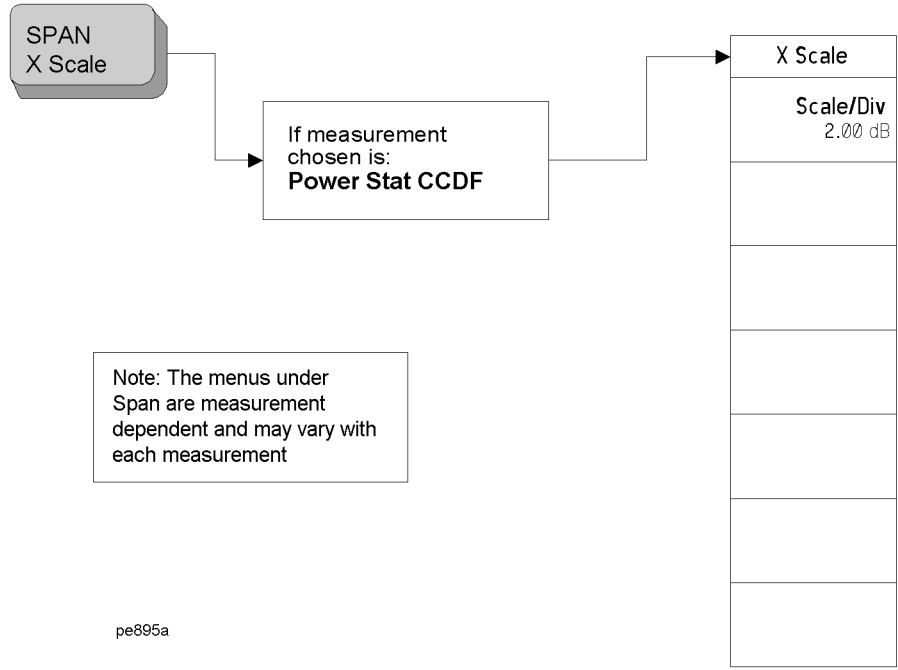

Note: The menus under Span are measurement dependent and may vary with each measurement

pe895a

Sweep Key (See page 241)

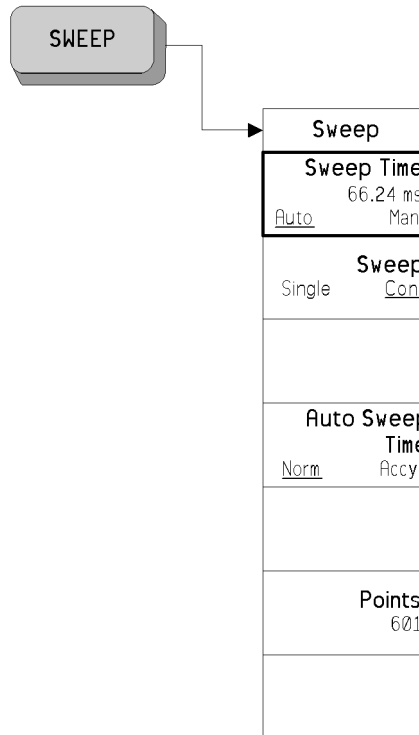

pe873a

System Key, 1 of 4 (See page 247)

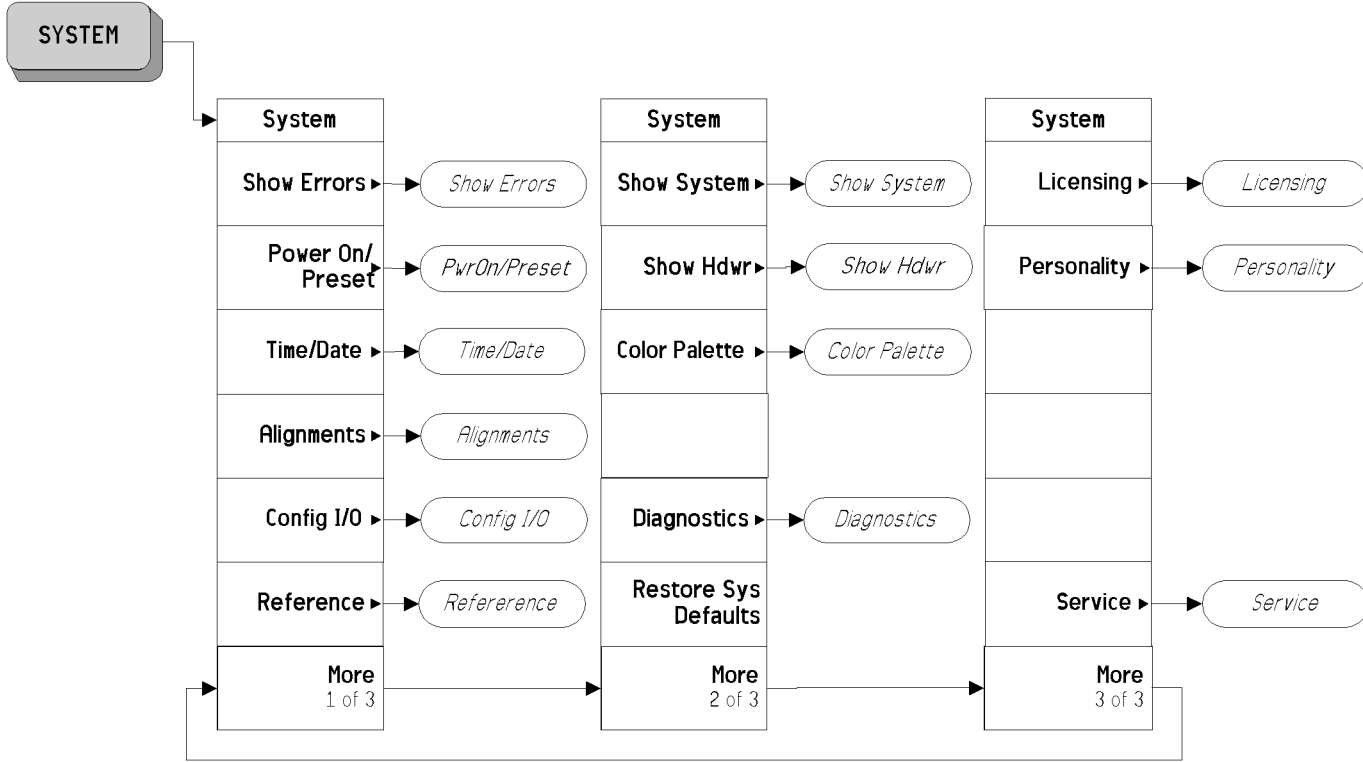

pe874a

System Key, 2 of 4 (See page 247)

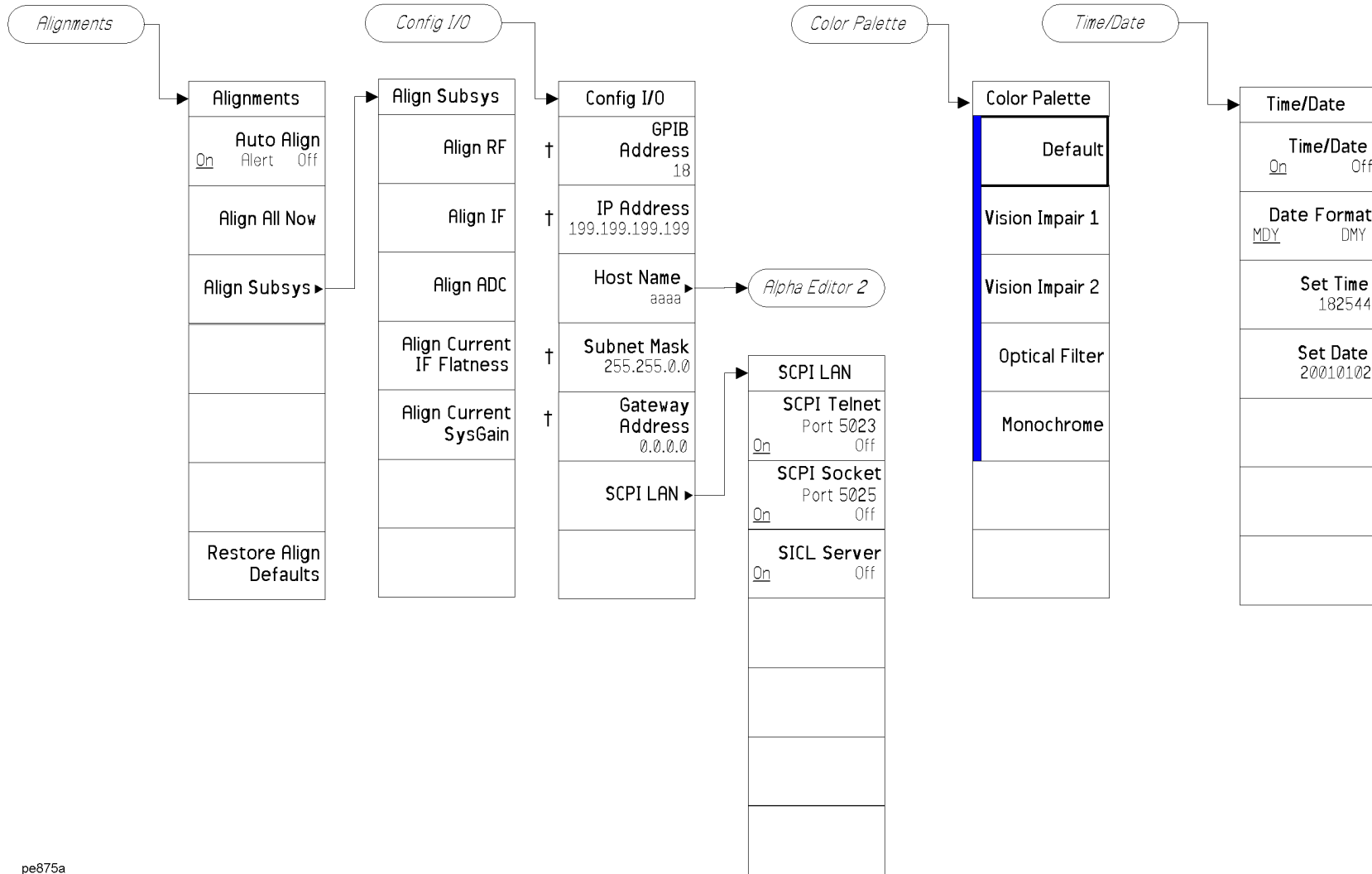

pe875a



A bar on the left of two or more softkeys indicates that the keys are a set of mutually exclusive choices.



A dagger to the left of the softkey indicates that when the key is pressed this is an active function.

System Key, 3 of 4 (See page 247)

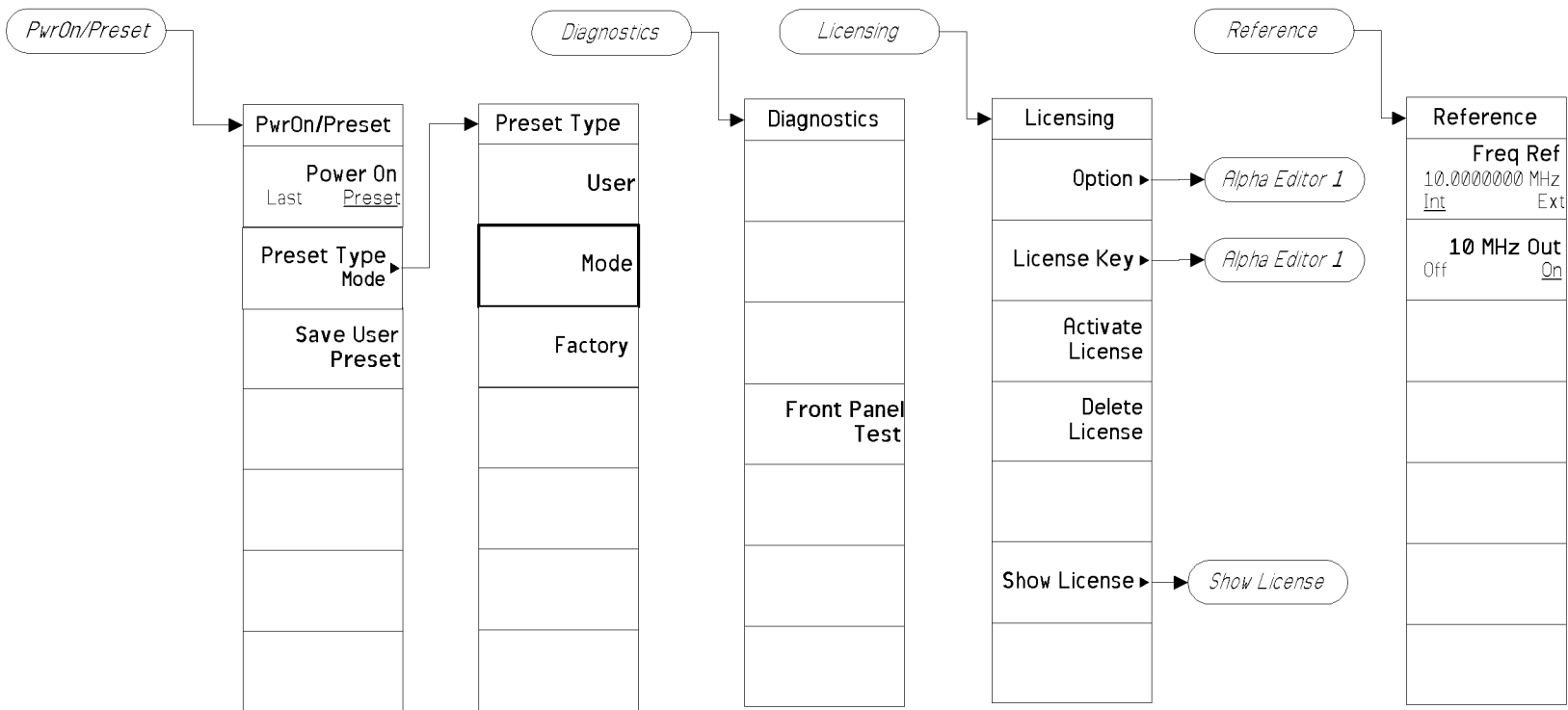

pe876a

System Key, 4 of 4 (See page 247)

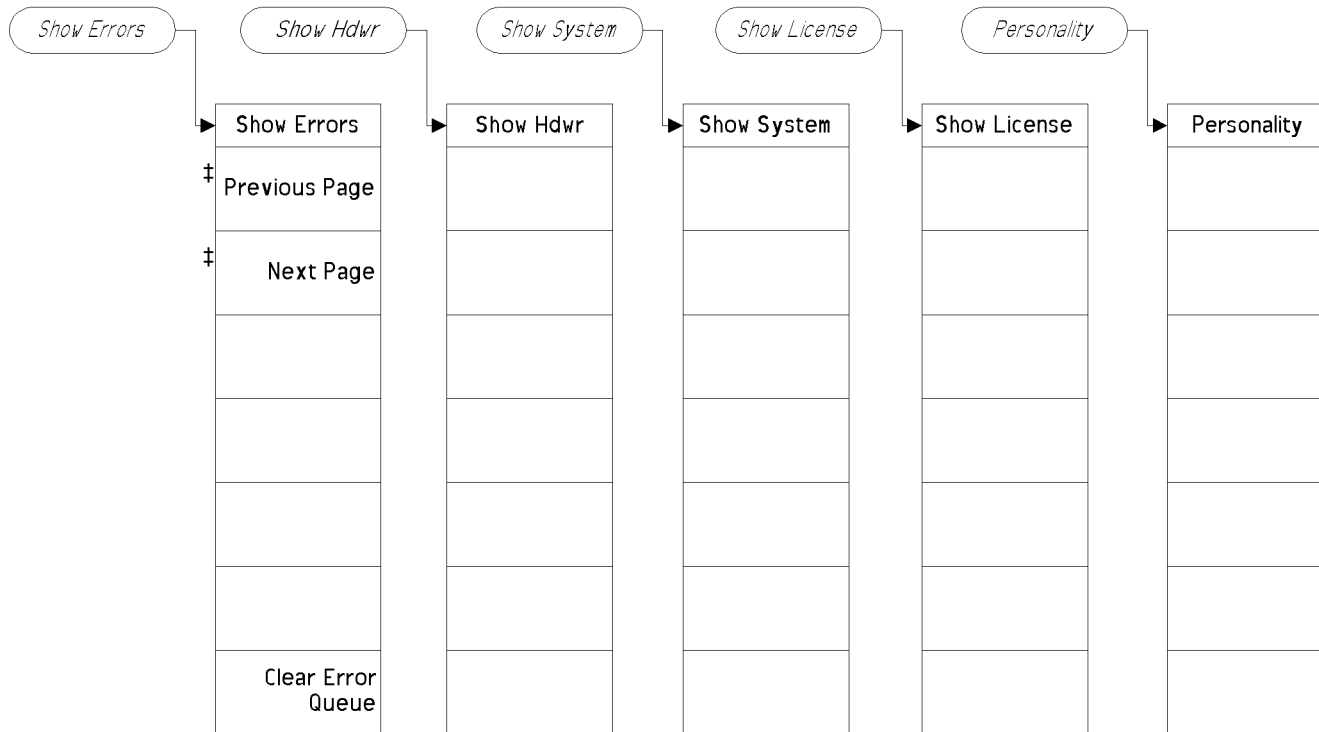

pe907a

‡ A double-dagger to the left of the softkey indicates a function that is not always available. It is dependent on other instrument settings.

Trace/View Key (See page 283)

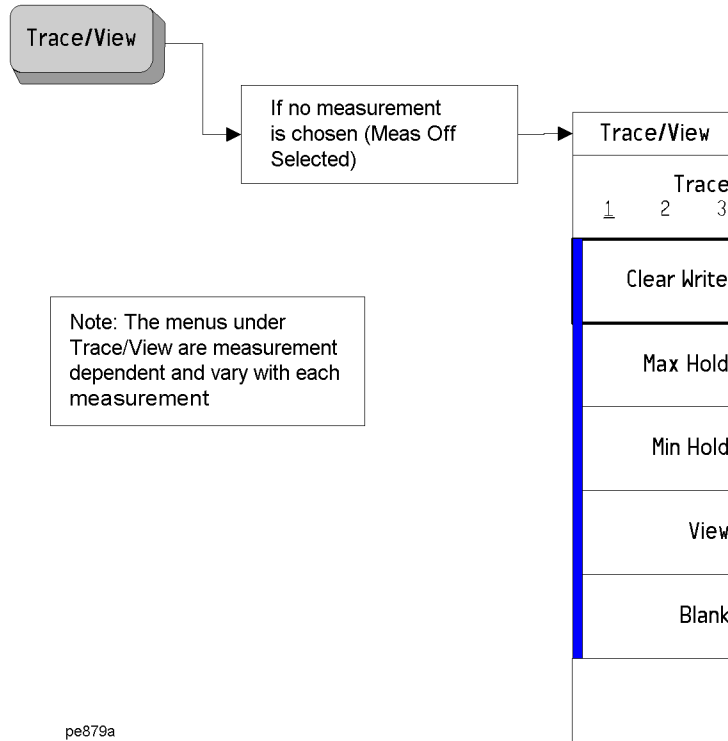

A bar on the left of two or more softkeys indicates that the keys are a set of mutually exclusive choices.

Trig Key (See page 287)

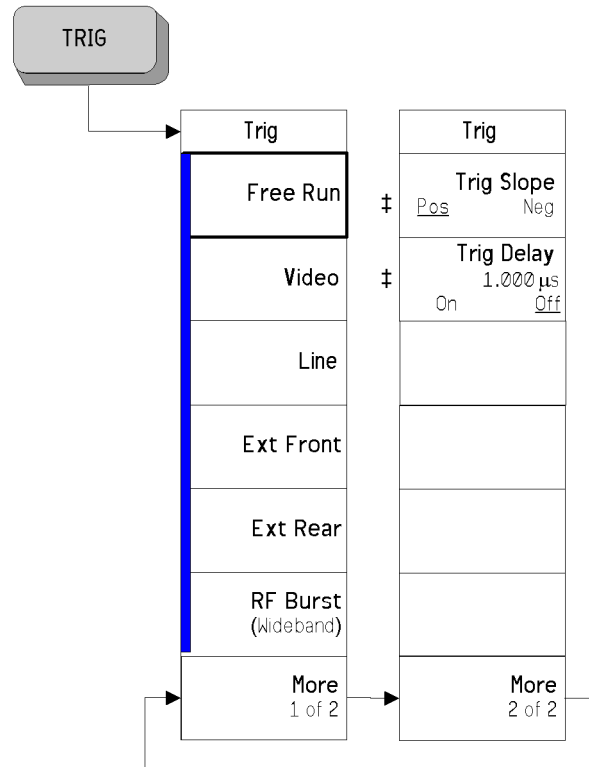

pe880a



A bar on the left of two or more softkeys indicates that the keys are a set of mutually exclusive choices.



A double-dagger to the left of the softkey indicates a function that is not always available. It is dependent on other instrument settings.

9 Menu Maps: One-Button Measurement Functions

This chapter provides you with menu maps for all measurements available to you when you press the front-panel **Measure** key (Spectrum Analysis mode is selected).

One-Button Measurement Menu Maps

This section provides a visual representation of all front-panel key menus associated with the measurements available when you press the front-panel **Measure** key. The key menus common to all measurements (**Measure**, **Meas Control**, and **Mode Setup**) are presented first. Then, the key menus unique to each measurement are displayed. Use the following table to locate the menus you wish to view and [Table on page 294](#) to locate the key descriptions and programming commands for these measurements.

Menu Map	Location	Menu Map	Location
Measure	Page 625	Multi-Carrier Power Menus	
Meas Control	Page 626	Meas Setup	Page 643
Mode Setup	Page 627	Trace/View	Page 644
ACP Menus		Occupied BW Menus	
Meas Setup	Page 629	Meas Setup	Page 645
Trace/View	Page 630	Spectrum Emission Mask Menus	
Burst Power Menus		Display	Page 648
Meas Setup	Page 631	Marker	Page 650
Trace/View	Page 632	Meas Setup	Page 646
CCDF Menus (Power Stat)		Span X Scale	Page 649
Display	Page 635	Trace/View	Page 647
Marker	Page 637	Spurious Emissions Menus	
Meas Setup	Page 633	Meas Setup	Page 651
Span X Scale	Page 636		
Trace/View	Page 634		
Channel Power Menus			
Meas Setup	Page 638		
Trace/View	Page 639		
Harmonic Distortion Menus			
Meas Setup	Page 640		
Trace/View	Page 641		
Intermod (TOI) Menus			
Meas Setup	Page 642		

MEASURE Key

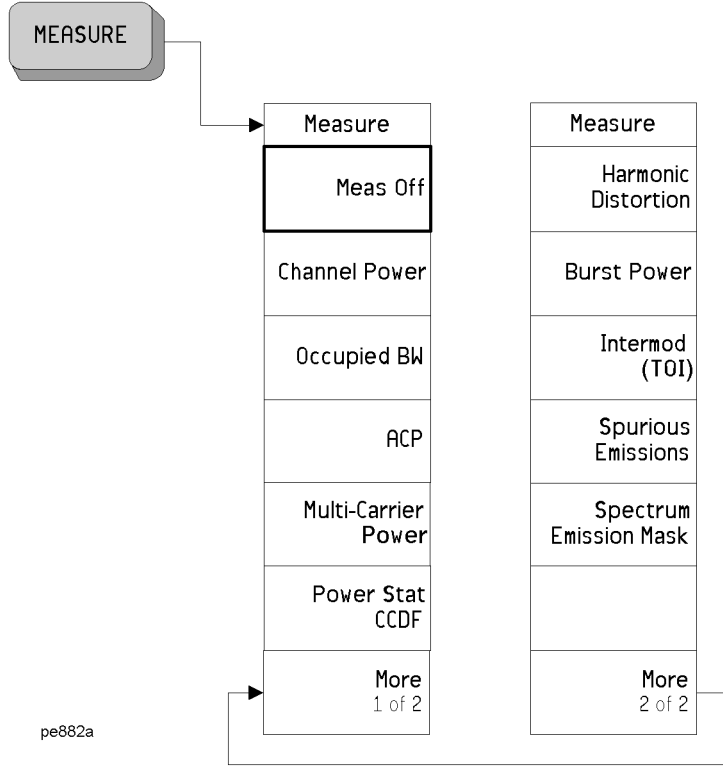

Meas Control Key

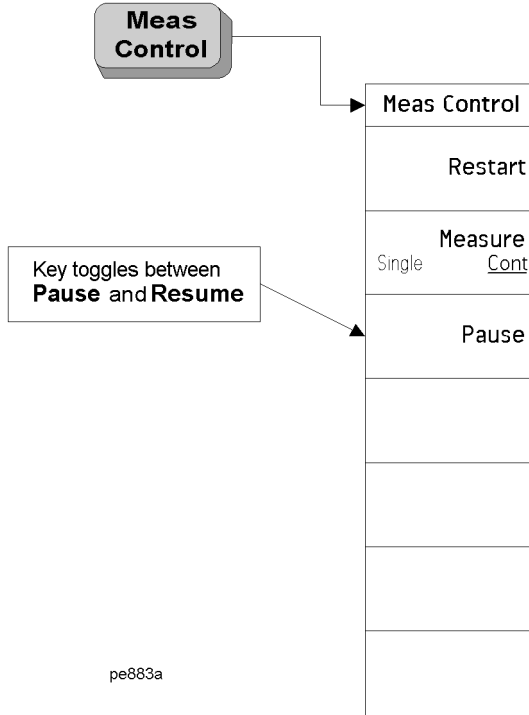

Mode Setup Key

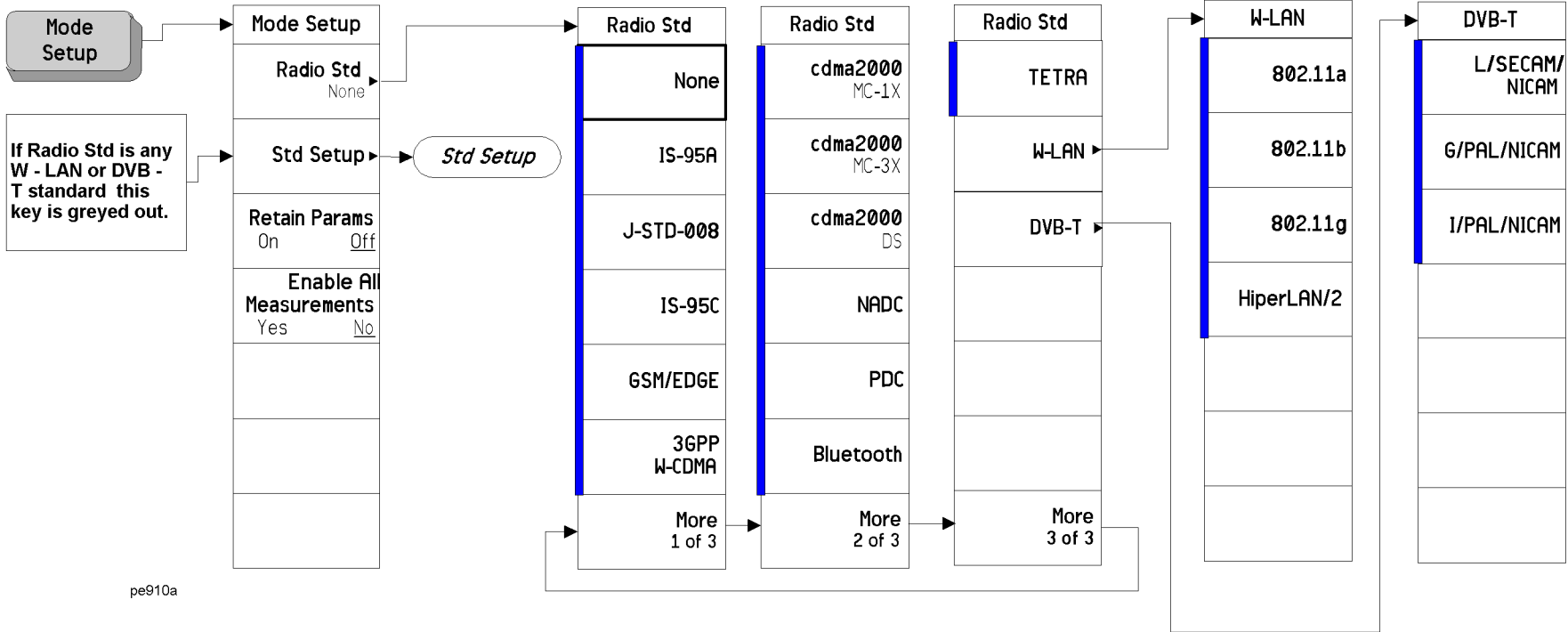

pe910a

A bar on the left of two or more softkeys indicates that the keys are a set of mutually exclusive choices.

Mode Setup Key (2 of 2)

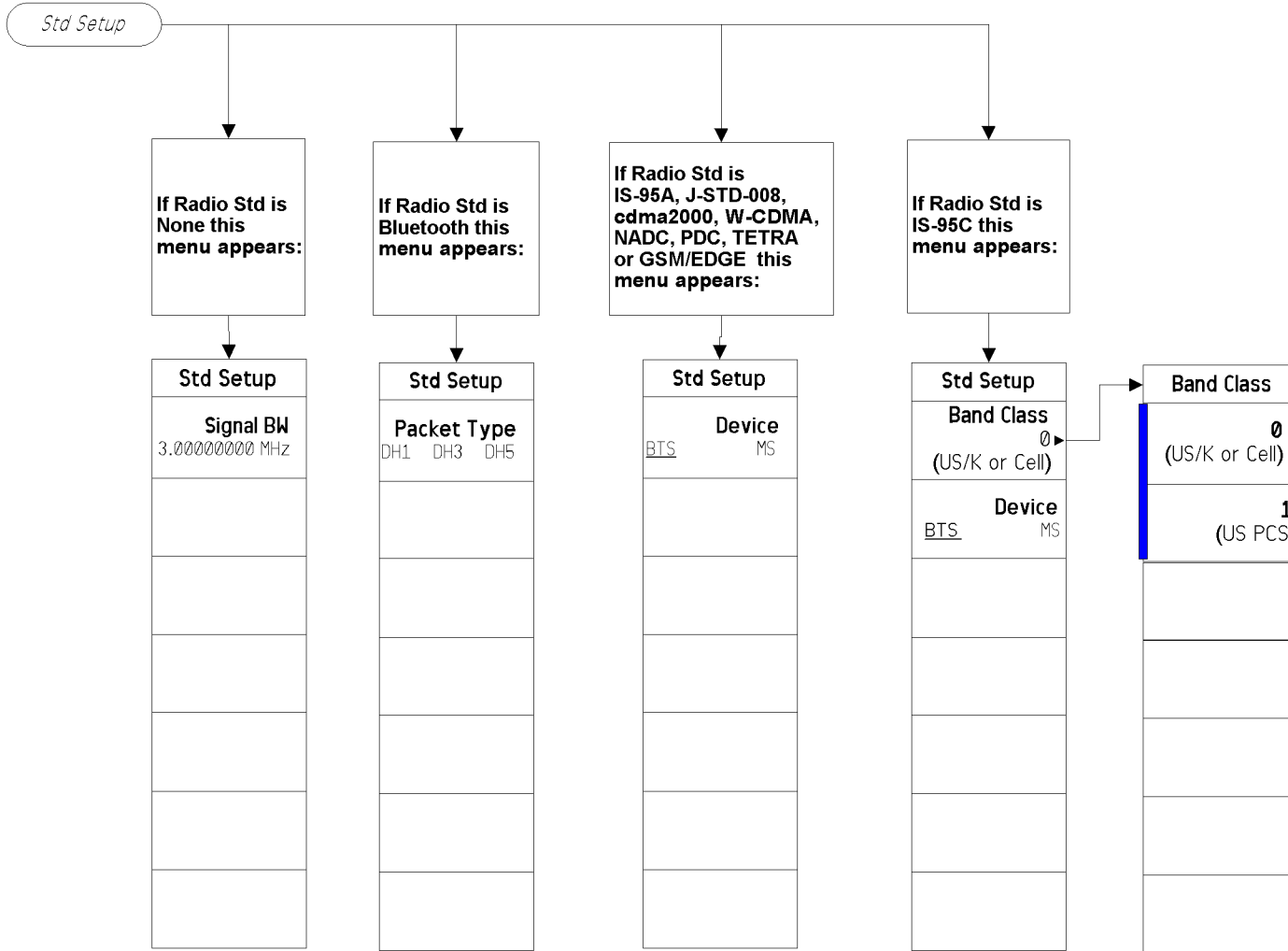

pe909a

■ A bar on the left of two or more softkeys indicates that the keys are a set of mutually exclusive choices.

ACP Measurement: Meas Setup Key

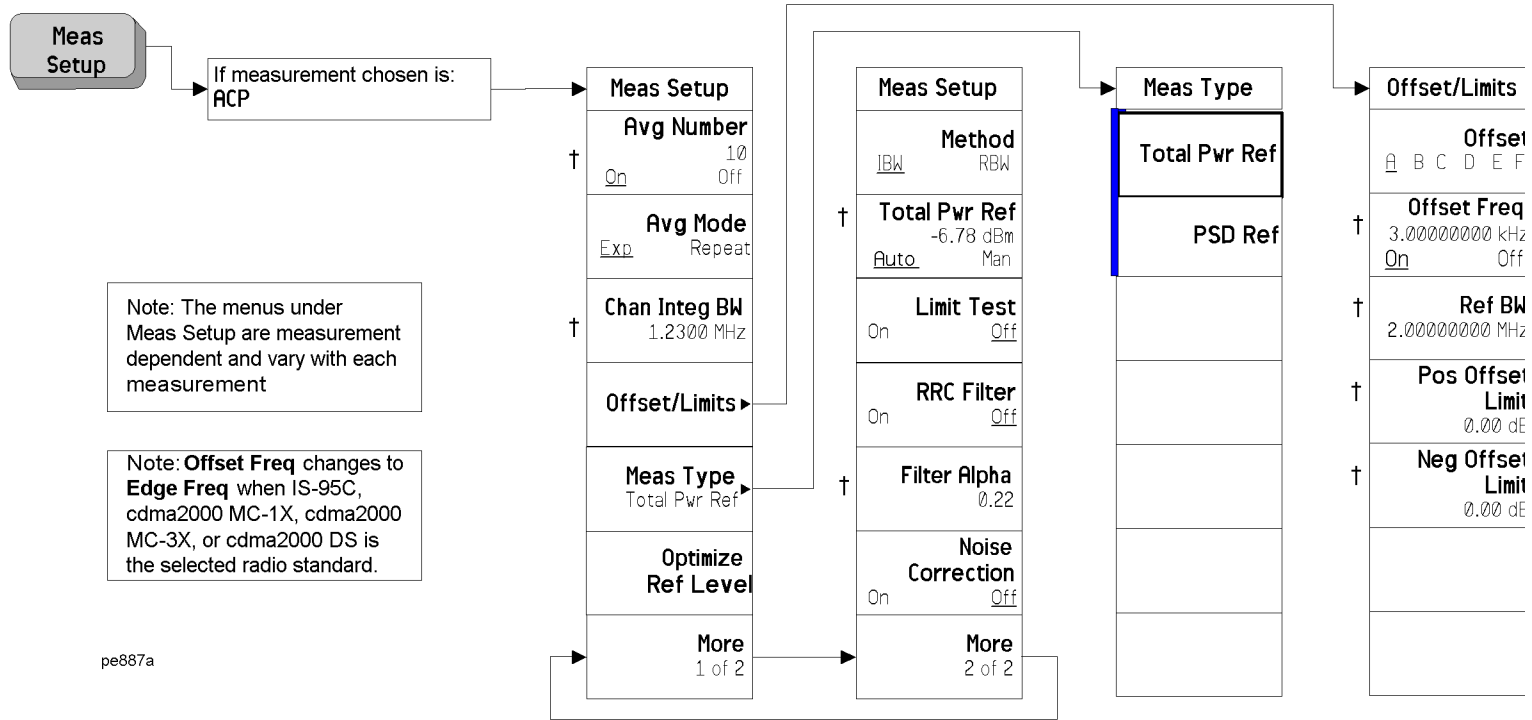

- A bar on the left of two or more softkeys indicates that the keys are a set of mutually exclusive choices.
- † A dagger to the left of the softkey indicates that when the key is pressed this is an active function.

ACP Measurement: Trace/View Key

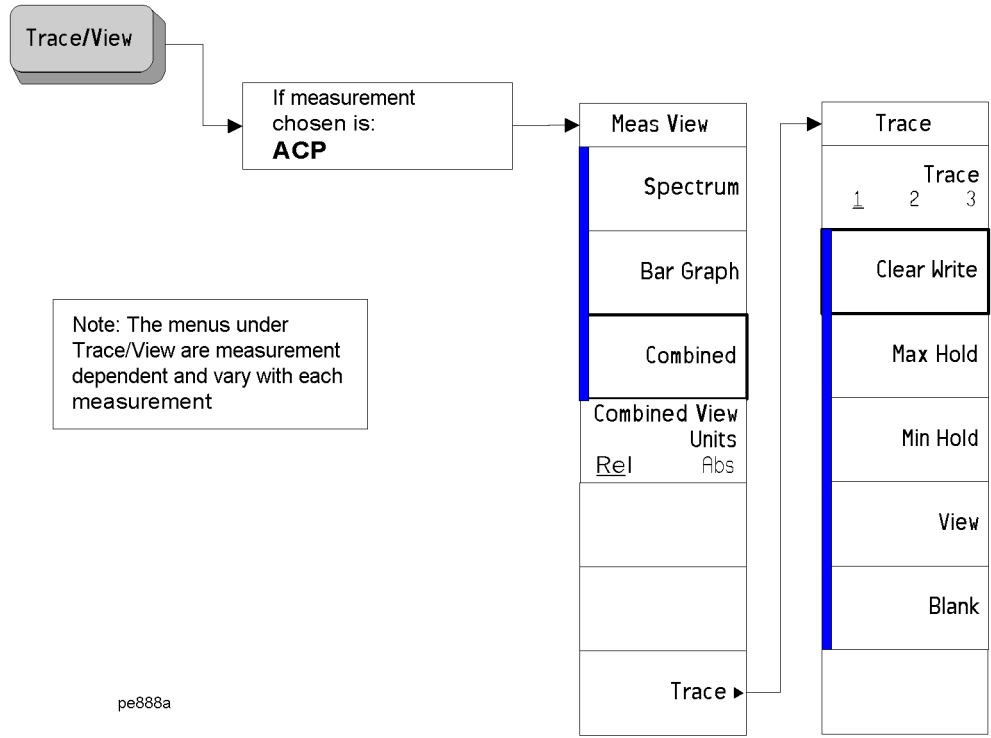

A bar on the left of two or more softkeys indicates that the keys are a set of mutually exclusive choices.

Burst Power Measurement: Meas Setup Key

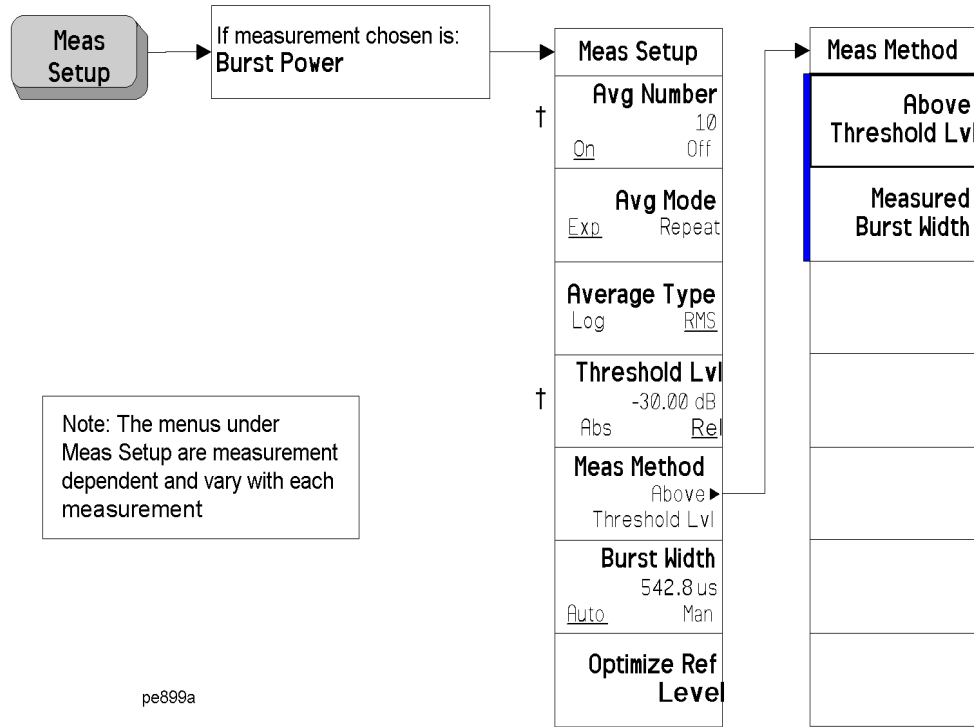

† A dagger to the left of the softkey indicates that when the key is pressed this is an active function.

Burst Power Measurement: Trace/View Key

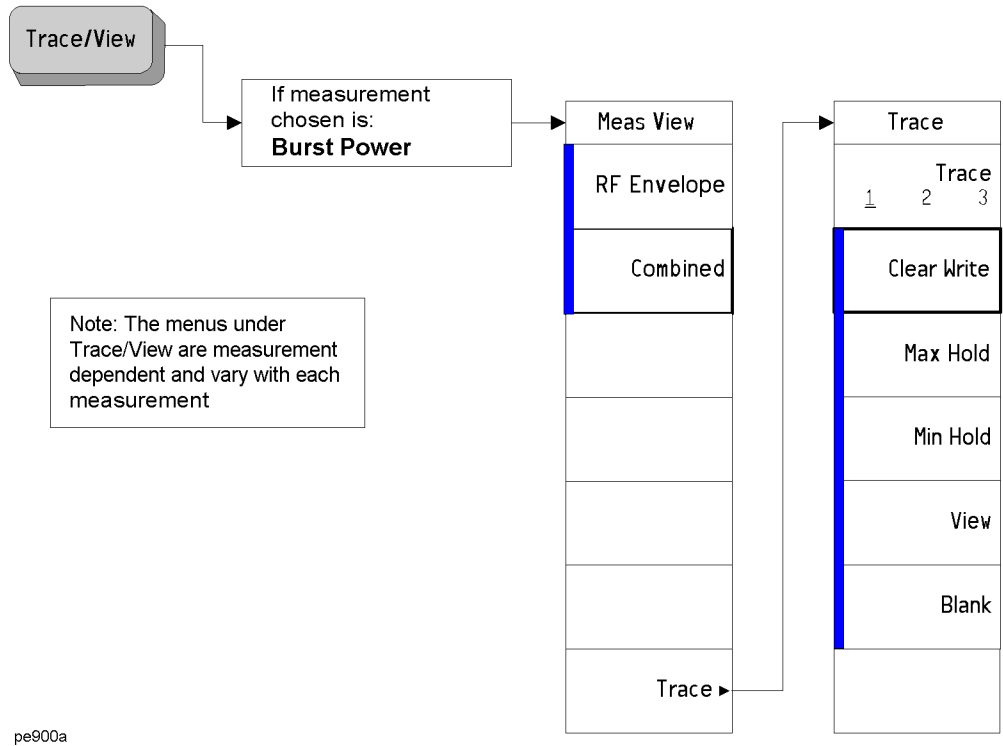

A bar on the left of two or more softkeys indicates that the keys are a set of mutually exclusive choices.

CCDF (Power Stat) Measurement: Meas Setup Key

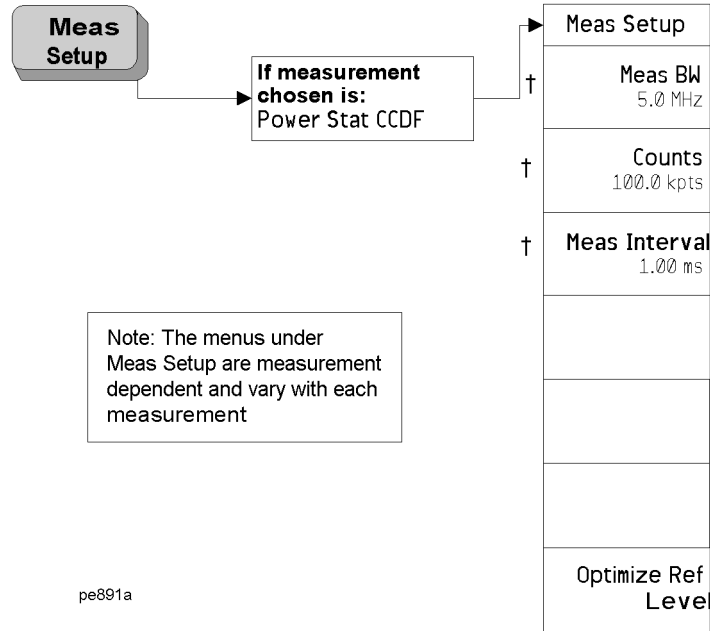

† A dagger to the left of the softkey indicates that when the key is pressed this is an active function.

CCDF (Power Stat) Measurement: Trace/View Key

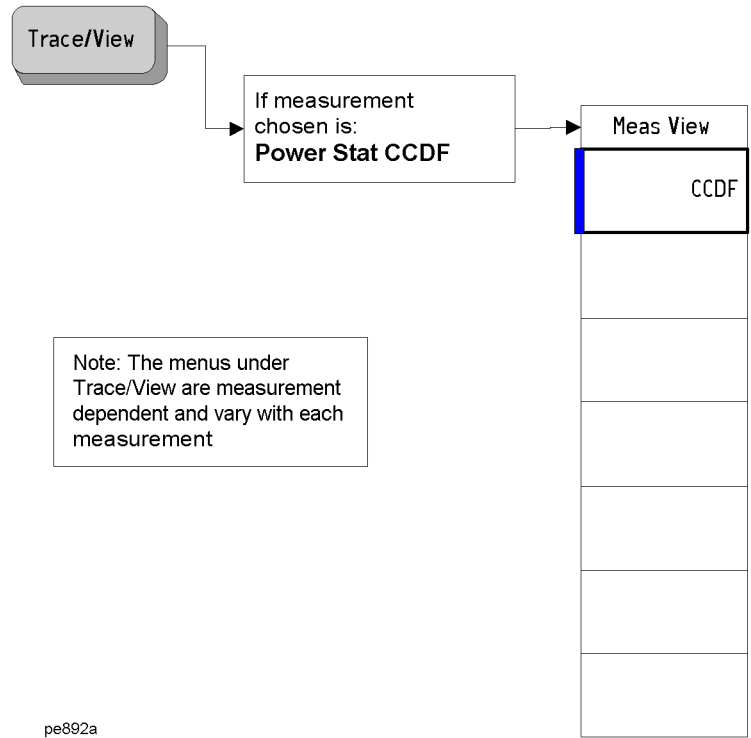

■ A bar on the left of two or more softkeys indicates that the keys are a set of mutually exclusive choices.

CCDF (Power Stat) Measurement: Display Key

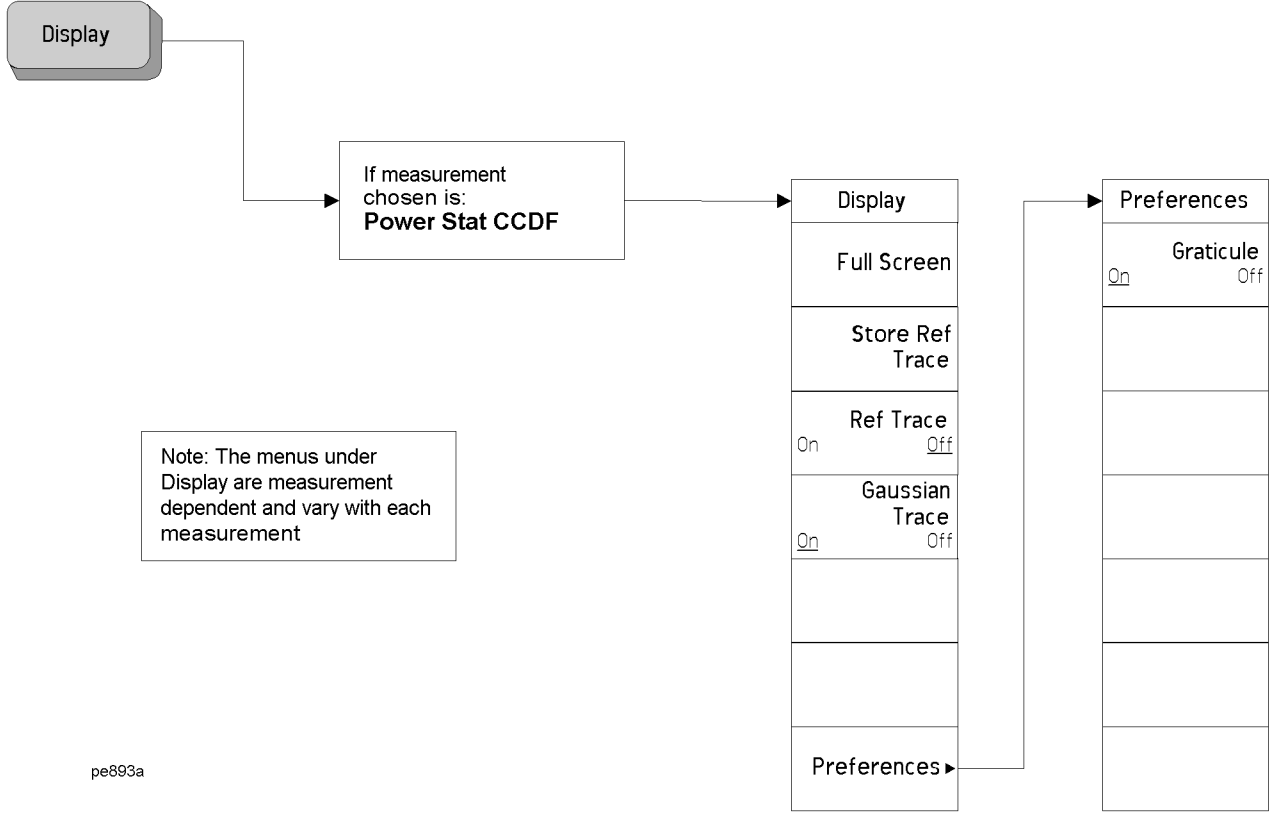

Note: The menus under Display are measurement dependent and vary with each measurement

pe893a

CCDF (Power Stat) Measurement: Span X Scale Key

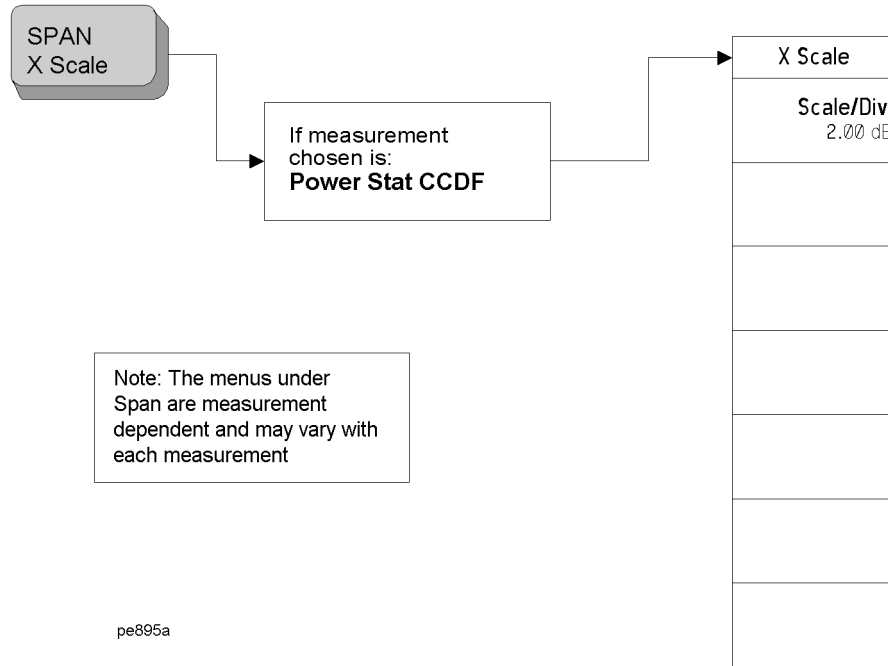

Note: The menus under Span are measurement dependent and may vary with each measurement

pe895a

CCDF (Power Stat) Measurement: Marker Key

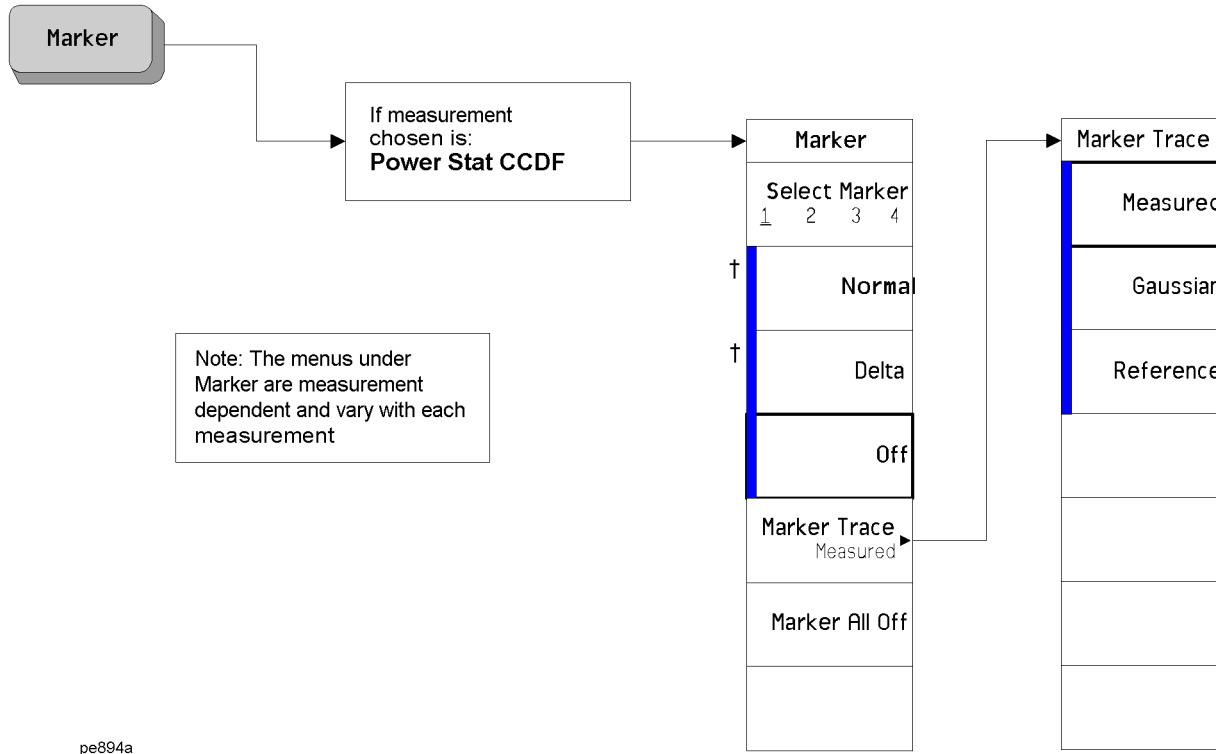

- A bar on the left of two or more softkeys indicates that the keys are a set of mutually exclusive choices.
- † A dagger to the left of the softkey indicates that when the key is pressed this is an active function.

Channel Power Measurement: Meas Setup Key

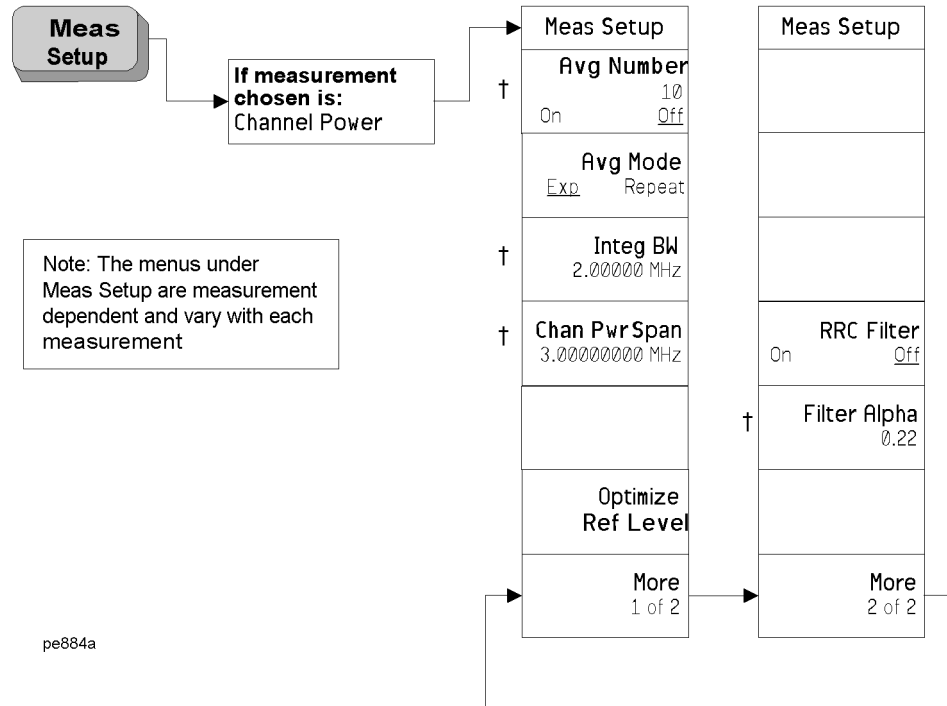

† A dagger to the left of the softkey indicates that when the key is pressed this is an active function.

Channel Power Measurement: Trace/View Key

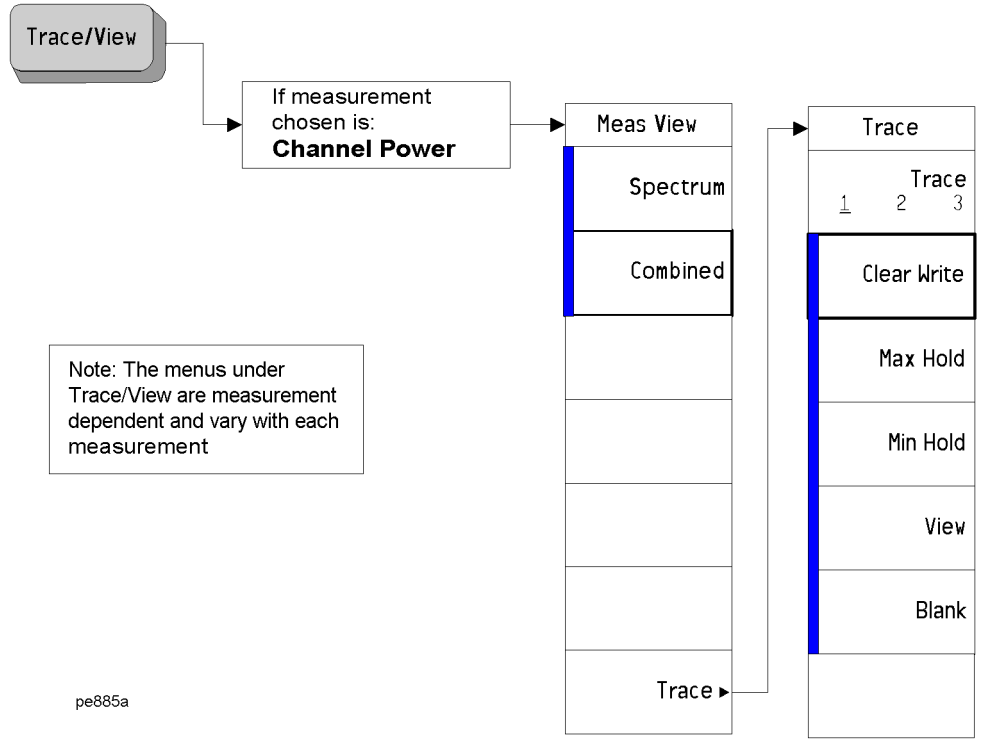

Note: The menus under Trace/View are measurement dependent and vary with each measurement

pe885a

A bar on the left of two or more softkeys indicates that the keys are a set of mutually exclusive choices.

Harmonic Distortion Measurement: Meas Setup Key

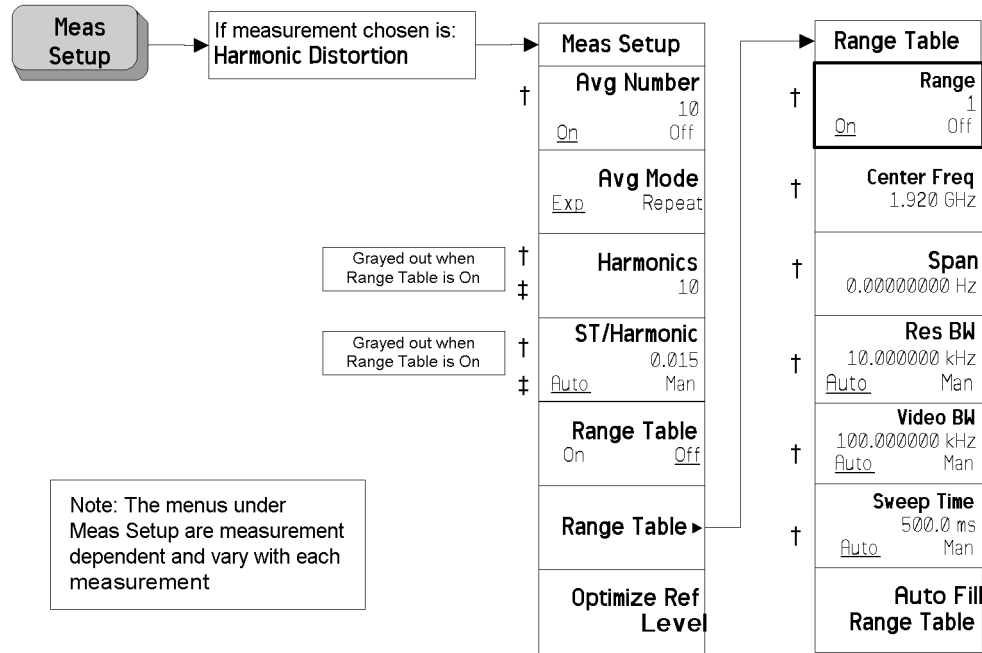

pe897a

- † A dagger to the left of the softkey indicates that when the key is pressed this is an active function.
- ‡ A double-dagger to the left of the softkey indicates a function that is not always available. It is dependent on other instrument settings.

Harmonic Distortion Measurement: Trace/View Key

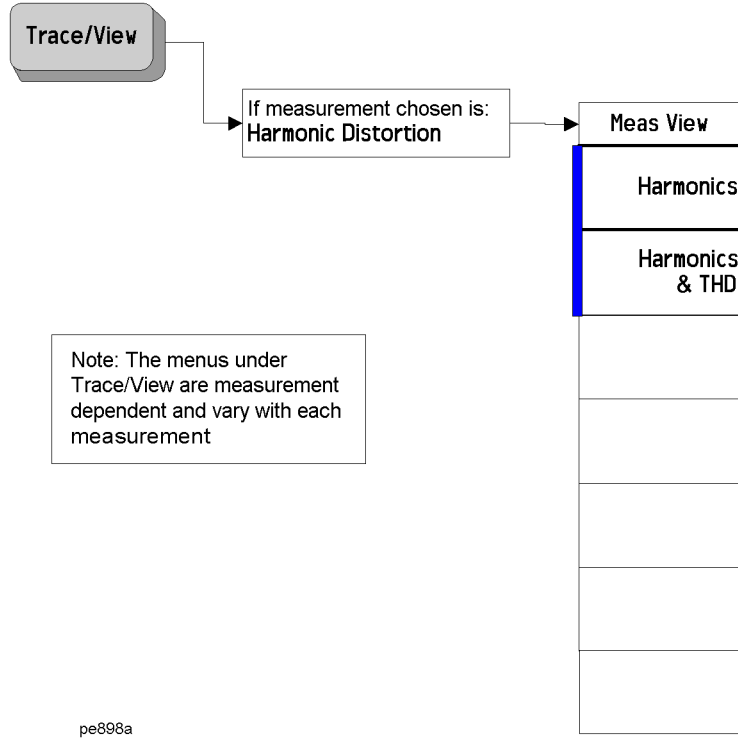

Note: The menus under Trace/View are measurement dependent and vary with each measurement

pe898a

A bar on the left of two or more softkeys indicates that the keys are a set of mutually exclusive choices.

Intermod (TOI): Meas Setup Key

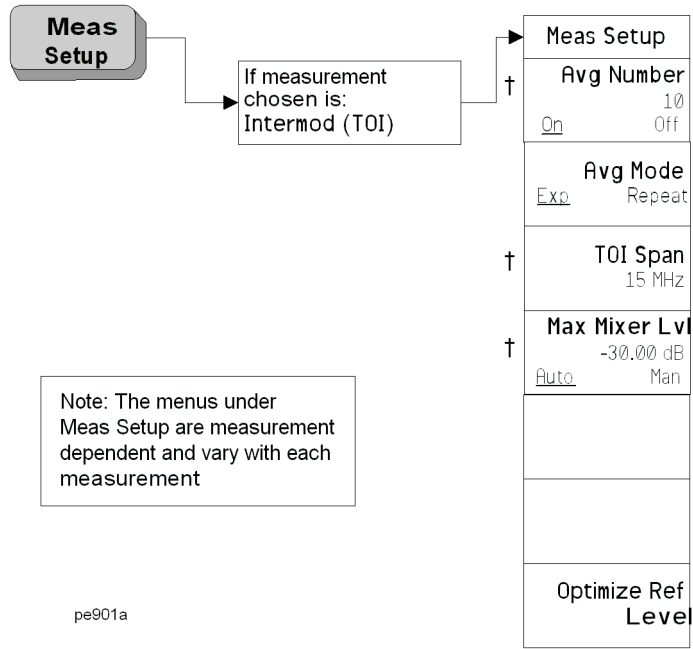

† A dagger to the left of the softkey indicates that when the key is pressed this is an active function.

Multi-Carrier Power Measurement: Meas Setup Key

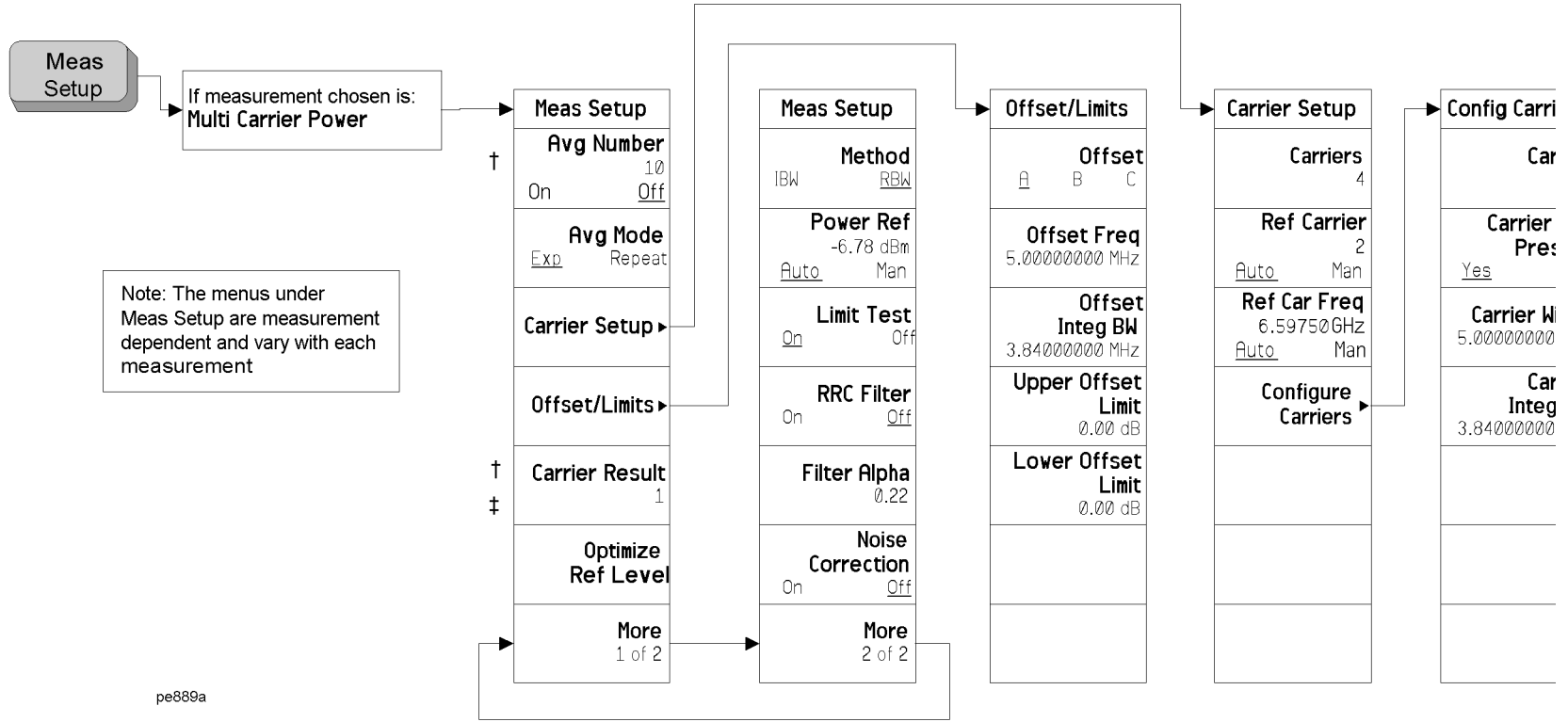

- † A dagger to the left of the softkey indicates that when the key is pressed this is an active function.
- ‡ A double-dagger to the left of the softkey indicates a function that is not always available. It is dependent on other instrument settings.

Multi-Carrier Power Measurement: Trace/View Key

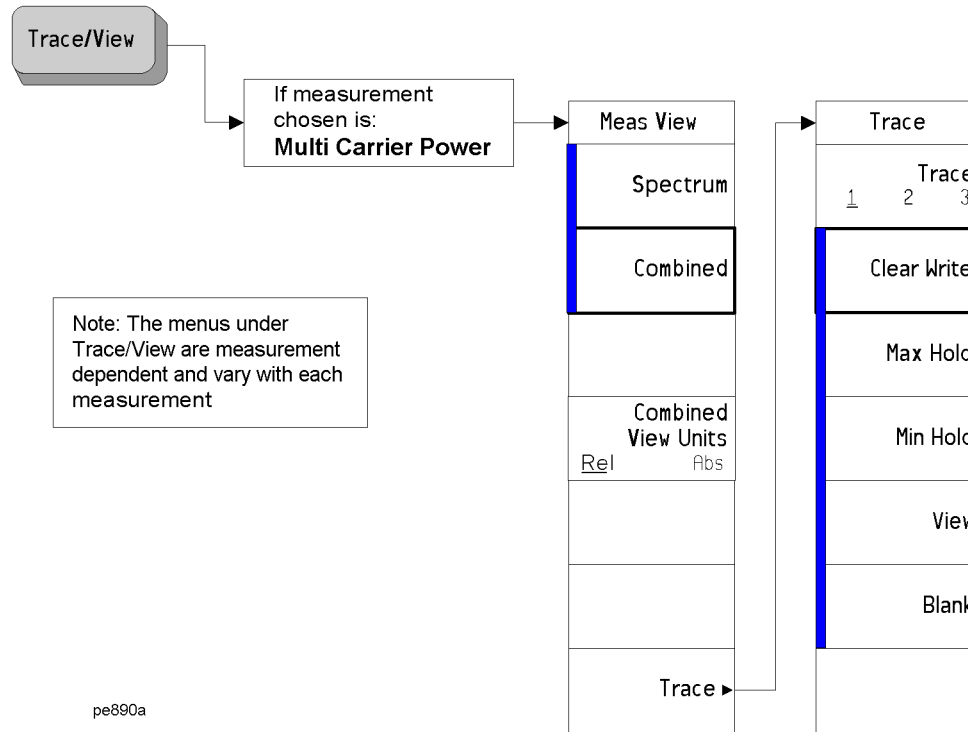

A bar on the left of two or more softkeys indicates that the keys are a set of mutually exclusive choices.

Occupied Bandwidth Measurement: Meas Setup Key

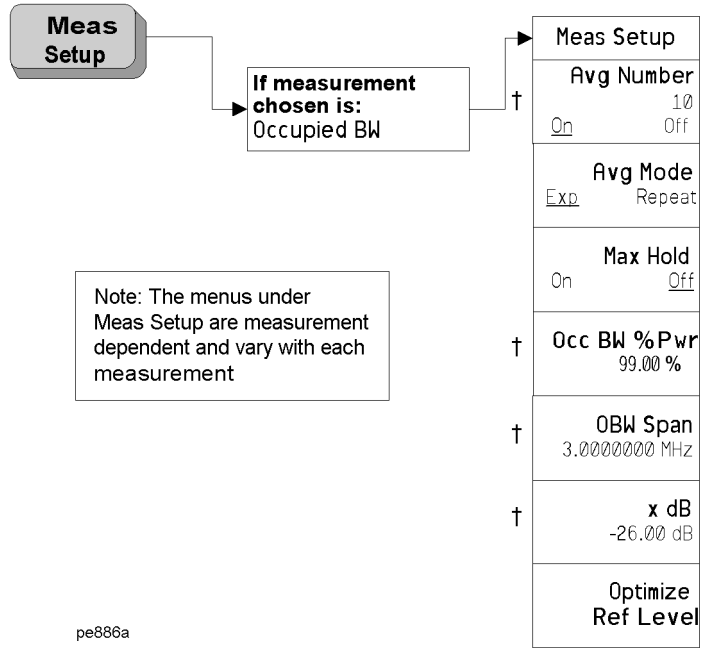

† A dagger to the left of the softkey indicates that when the key is pressed this is an active function.

Spectrum Emission Mask Measurement: Meas Setup Key



Note: The menus under Meas Setup are measurement dependent and vary with each measurement

Meas Type: This key will be greyed out and set to PSD Ref when Radio Std = 802.11a, 802.11b, or HiperLAN/2

Total Pwr Ref key: title will be Total Pwr Ref or PSD Ref depending on currently selected Meas Type

- A bar on the left of two or more softkeys indicates that the keys are a set of mutually exclusive choices.
- † A dagger to the left of the softkey indicates that when the key is pressed this is an active function.

Spectrum Emission Mask Measurement: Trace/View Key

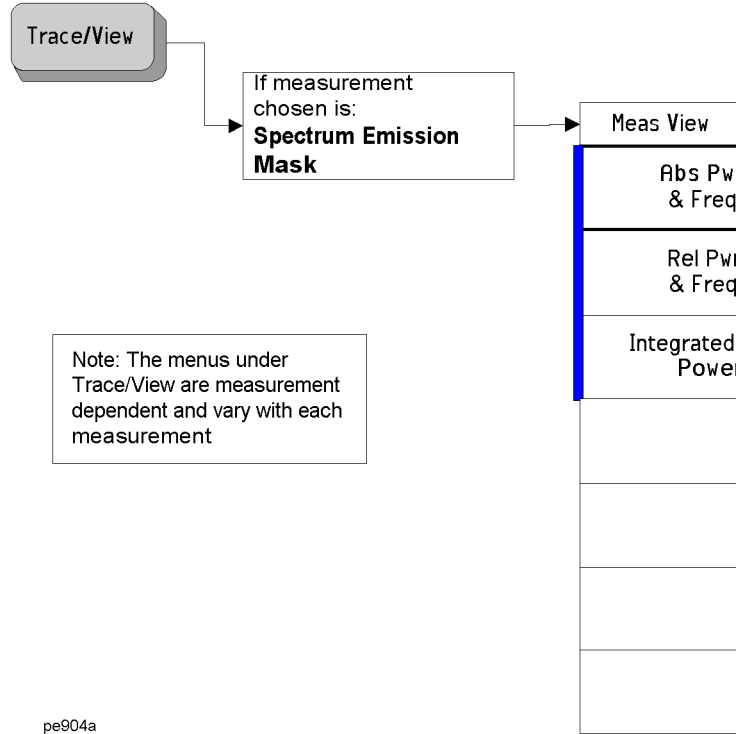

Note: The menus under Trace/View are measurement dependent and vary with each measurement

pe904a

A bar on the left of two or more softkeys indicates that the keys are a set of mutually exclusive choices.

Spectrum Emission Mask Measurement: Display Key

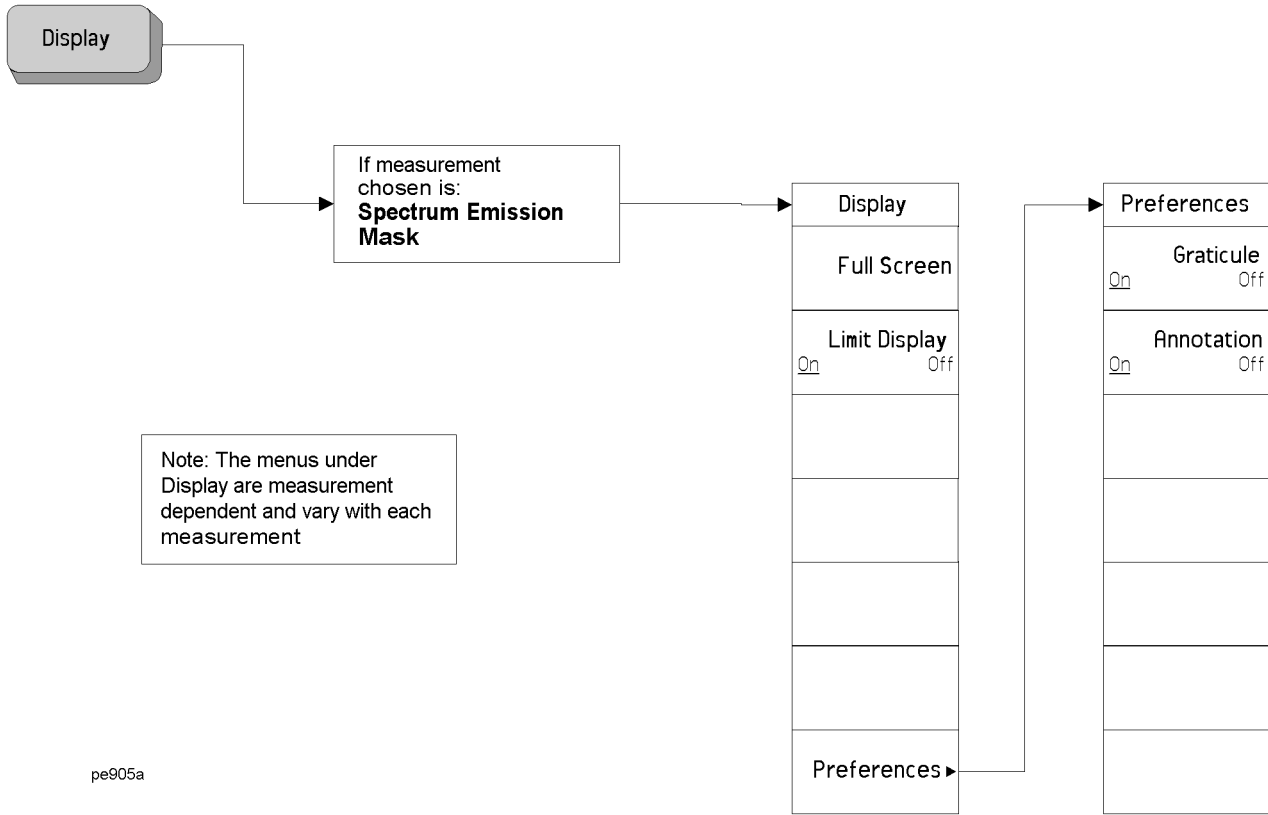

Spectrum Emission Mask Measurement: Span X Scale Key

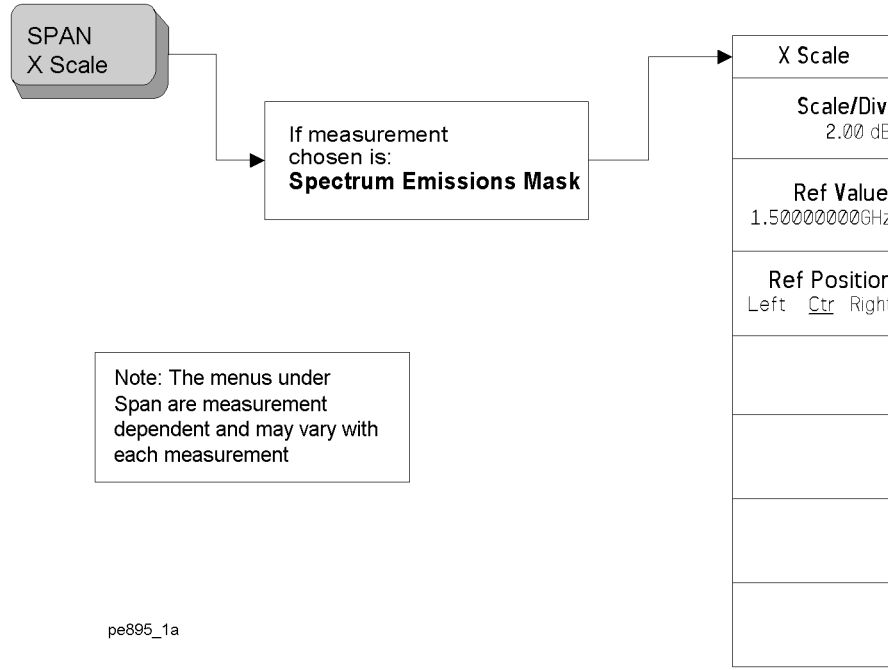

Note: The menus under Span are measurement dependent and may vary with each measurement

pe895_1a

Spectrum Emission Mask Measurement: Marker Key

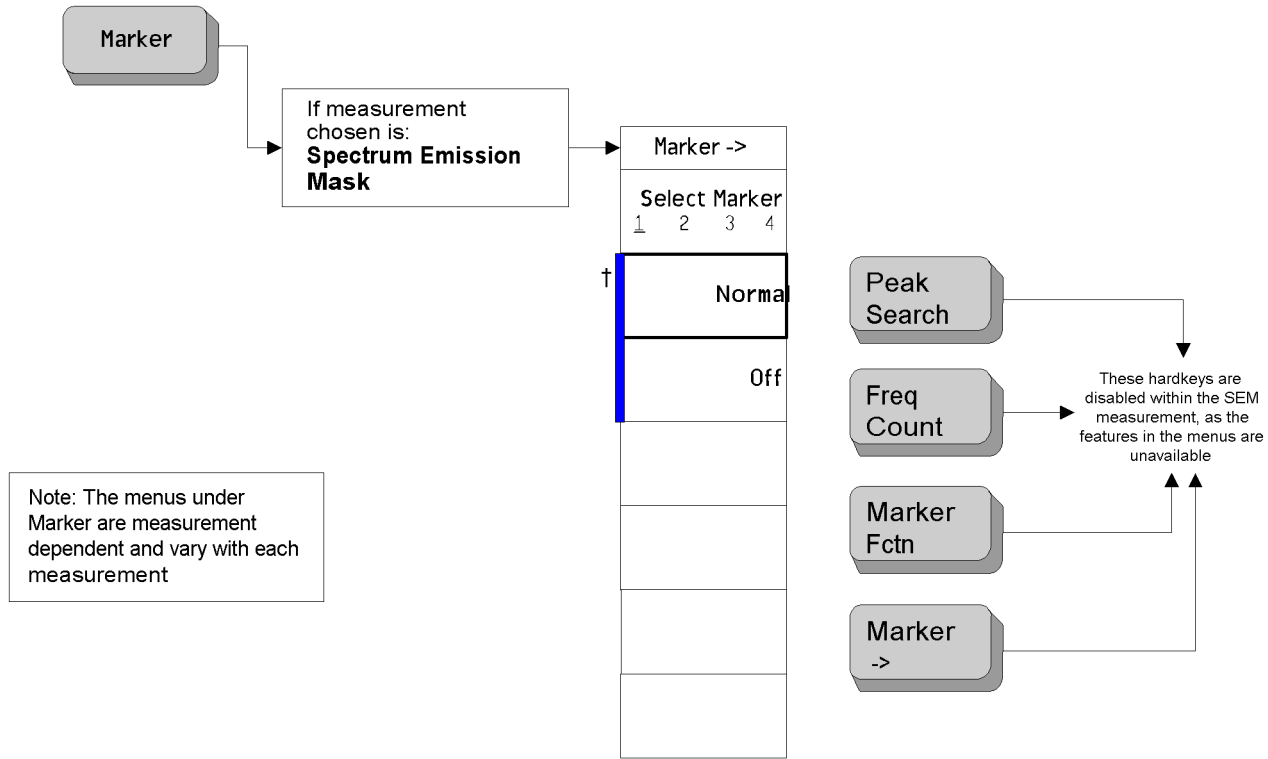

pe906a

A bar on the left of two or more softkeys indicates that the keys are a set of mutually exclusive choices.

Spurious Emissions Measurement: Meas Setup Key

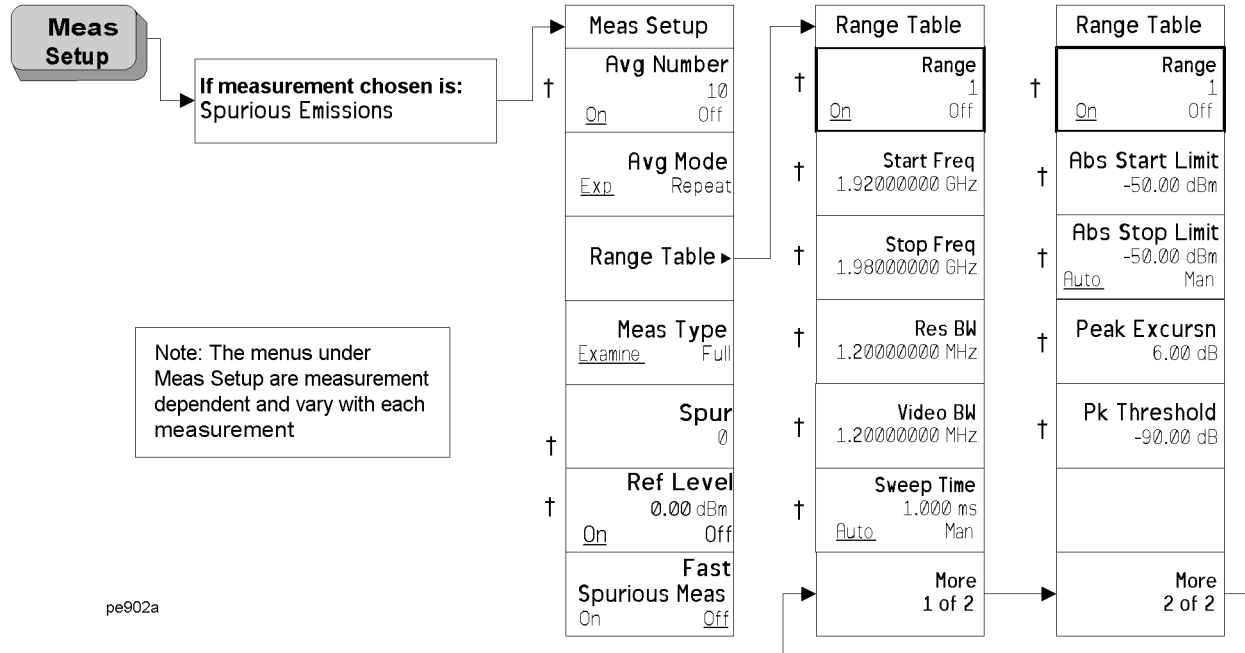

† A dagger to the left of the softkey indicates that when the key is pressed this is an active function.

**Menu Maps: One-Button Measurement
Functions**

Symbols

*LRN, 564
*RST, 45

Numerics

10 dB step, 68
10 MHz Out key, 270
2 dB step, 68
3GPP W-CDMA key, 335
488.2 IEEE commands, 563
802.11a key, 338
802.11b key, 339
802.11g key, 339

A

absolute limit, 493, 495
Absolute Limit key, 493, 495
ACP
 Meas Setup menu, 629
 Trace/View menu, 630
ACP key, 305
Activate key, 277
ADC dither
 automatic, 79
 off, 80
 on, 80
ADC Dither key, 79
ADC ranging
 automatic, 80
 bypass, 80, 81
ADC Ranging key, 80
adjacent channel power
 key, 305
 measurement, 305
 measurement setup, 351
adjacent channel power
 measurement
 measurement setup, 371
 trace, 367
 viewing trace, 367
Agilent Technologies URL, 2
align
 now, 568
Align ADC key, 259
Align All Now key, 257
Align Current IF Flatness key,
 259
Align Current SysGain key, 261
Align IF key, 258
Align RF key, 258
Align Subsys key, 258
aligning
 ADC, 259
 align all, 257
 automatic align, 255
 IF, 258

 IF flatness, 259
 RF, 258
 subsystems, 258
 system gain, 261
alignment functions, 279
alignments
 time corrections, 262
Alignments key, 255, 268
All key, 131
All Traces key, 142
alpha, 401
alpha editor
 menu map, 588, 589
Amplitude key, 115
amplitude reference, 171
amplitude Y scale
 menu map, 590, 591
AMPLITUDE Y Scale front-panel
 key, 49
Amptd Interp key, 119
Amptd Ref key, 171
angle parameter (variables), 507
Annotation key, 125, 480
antenna
 correction, 61
Antenna correction key, 61, 62,
 64
applet, 538
applications
 installing, 278
 selecting, 203, 204, 206
applications, selecting, 203
Appling Corrections key, 61
arbitrary block data, 508
ASCII data format, 160
Attenuation key, 50
attenuator step
 10 dB, 68
 2 dB, 68
Attn Step key, 68
Auto Align key, 255
Auto All key, 71
auto couple, 71
 menu map, 592, 593, 594
AUTO COUPLE front-panel key,
 71
auto coupling
 Auto All, 71
Auto key, 90, 97
 phase noise, 76
Auto Sweep Time key, 243
Autorange key
 ADC ranging
 autorange, 81
Average key, 87, 98
average mode, 353, 372, 409, 430,
 486

average number, 351, 399, 429,
 485
averaging, 87
 log-power, 89
 power, 89
 traces, 451, 452, 582, 583
 type, 93
 Auto, 90
 Log power, 90
 power, 91
 voltage, 91
 video, 89
 voltage, 89
Avg Mode key, 353, 372, 409, 430,
 452, 486
Avg Number key, 351, 371, 399,
 409, 423, 429, 451, 457, 485
Avg/VBW Type key, 89, 93
 phase noise, 78

B

B,M,T measurements, 514
Band Class key, 342
Band/Intvl Power key, 193
bandwidth power, 193
bandwidth ratio
 video to resolution, 86
base station setup, 341
BASIC programming, 531
binary data order, setting, 160
bit_pattern parameter
 (variables), 507
Bitmap
 format, 141
 screen file, 129
Bitmap key, 141
Blank key, 286, 370, 379, 407,
 450
block data
 arbitrary, 508
 identifying block size, 508
 parsing output, 508
Bluetooth key, 338
book
 terms, 45
book, using, 44
boolean parameter (commands),
 506
bottom/middle/top
 measurements, 514
Burst Power
 Meas Setup menu, 631
 Trace/View menu, 632
burst power measurement,
 trace/view, 377
bus
 clear command, 530

- LAN, 524
 - LAN cable, 544
 - BW/Avg
 - menu map, 595
 - BW/Avg front-panel key, 83, 180, 181, 184, 185, 186, 187, 188, 189, 201, 329, 330, 331, 391, 392, 394, 483
 - By Date key, 133
 - By Extension key, 135
 - By Name key, 133
 - By Size key, 135
 - Bypass key, 81
 - byte order, setting data, 160
 - C**
 - C language
 - addressing sessions, 551
 - closing sessions, 553
 - compiling and linking, 547
 - creating, 546
 - example, 549
 - opening session, 549
 - sessions, 550
 - using VISA library, 546
 - using VISA transition library, 547, 549
 - C programming, socket LAN, 538
 - cable
 - correction, 61
 - cable, LAN, 544
 - calibration
 - amount displayed, 261
 - condition register, 575, 576
 - defaults, 261
 - frequency corrections on/off, 257
 - functions, 279
 - IEEE command, 563
 - query, 563
 - time corrections, 262
 - calibration condition register, 575, 576
 - Carrier IntegBW key, 437
 - Carrier key, 434
 - Carrier Pwr Present key, 434
 - Carrier Result key, 441
 - Carrier Setup key, 430
 - Carrier Width key, 435
 - Carriers key, 431
 - Catalog
 - key, 130
 - CCDF (Power Stat)
 - Display menu, 635
 - Marker menu, 637
 - Meas Setup menu, 633
 - SPAN X Scale menu, 636
 - Trace/View menu, 634
 - CCDF measurement
 - Display key, 385
 - display settings, 385
 - cdma2000 SR1 key, 335
 - cdma2000 SR3-DS key, 336
 - cdma2000 SR3-MC key, 336
 - Cell
 - band class, 342
 - Center Freq key, 163, 415
 - center frequency, marker to, 212
 - center frequency, 415
 - CF Step key, 166
 - Chan Integ BW key, 353
 - Chan Integ Bw key, 459
 - Chan Pwr Span key, 389, 401
 - Chan Span key, 459
 - Change Title key, 122
 - changing
 - frequency span, 237, 238, 239, 481
 - Channel Power
 - Meas Setup menu, 638
 - Trace/View menu, 639
 - Channel Power key, 301
 - channel power measurement, 301
 - measurement setup, 399
 - storing trace, 479
 - trace, 405
 - viewing trace, 405, 479
 - channel power span, 389, 401
 - Clear Error Queue key, 248
 - clear status, IEEE command, 563
 - Clear Title key, 123
 - Clear Write key, 285, 369, 379, 406, 450
 - clearing errors, 248
 - code, programming
 - compatibility across PSA modes, 519, 521
 - compatibility, PSA series versus VSA, 522
 - Color Capable key, 230
 - Color key, 234
 - color palette
 - defaults, 271
 - selecting, 274
 - Color Palette key, 271
 - Combined key, 378
 - command complete, 565
 - commands
 - boolean parameter, 506
 - compatibility across PSA modes, 519, 521
 - CONFigure, 298
 - FETCh, 299
 - keyword parameter, 506
 - MEASure, 298
 - multiple on a line, 508
 - parameters, 506
 - PSA series versus VSA
 - compatibility, 522
 - READ, 299, 300
 - syntax, 503
 - termination, IEEE, 509
 - units parameter, 506
 - valid commands, 504
 - variable parameter, 506
 - variable parameter keywords, 506
- compatibility, programming
 - across PSA modes, 519
 - PSA series versus VSA, 522
- complementary cumulative distribution function measurement
 - measurement setup, 381
- condition of instrument, 557
- Config I/O key, 262
- configuration
 - GPIB address, 263
 - host ID, 264
 - host name, 264
 - IP address, 263, 265
 - LAN, 265
- Configure Carriers key, 434
- CONFigure commands, 298
- Connected To Previous key, 116
- connection errors, 539
- connection refused error, 541
- connection timed out error, 541
- continuous measurements, 329
- Continuous Pk key, 212, 213
- control keys, 47, 175, 207
- Control LAN Telnet key, 266
- Control SICL LAN key, 267
- Control Socket LAN key, 266
- controller, 554
- controlling
 - gate time, 196
- Copy key, 151
- Copy Now key, 151
- copying
 - files, 151
- correction
 - antenna, 61, 62, 64
 - cable, 61
 - frequency, 64, 66, 67
 - other, 61
 - user, 61
- correction constant default, 261
- Corrections
 - file type, 129
- corrections
 - applying, 61

- time, 262
- Corrections key, 59, 133
- counter, 194
- Counts key, 382
- Coupling key, 172
- couplings, 45
- Create Dir key, 155
- Create Dir Now key, 155
- creating
 - directories, 155
 - directories now, 155
- CSV
 - format, 141
- CSV key, 141
- CSV trace type, 129
- current measurement, query, 328
- D**
- data
 - arbitrary blocks, 508
- data acquisition sampling points, 382
- data byte order
 - setting, 160
- data format, 160
- data to a file
 - moving, 158
- date
 - display on/off, 253
 - displaying, 252
 - setting, 252
- Date Format key, 253
- dBm key, 57
- dBmV key, 57
- dBuV key, 57
- default
 - color palette, 271
- Default key, 271
- default values, setting remotely, 298
- defaults
 - LAN, 539
 - restoring
 - system, 274
- defining
 - limits, 108
- definitions
 - dependencies/couplings, 45
 - example, 45
 - factory preset, 45
 - maximum value, 45
 - remote command, 45
 - state saved, 45
 - terms, 45
- degree parameter(variables), 507
- Delete
 - key, 278
- Delete All key, 157
- Delete All Limits key, 122
- Delete All Now key, 157
- Delete key, 147
- Delete Limit key, 116
- Delete Now key, 149
- Delete Point key, 116
- deleting
 - files, 147, 149, 157
 - limits, 122
 - options, 278
- Delta key, 181, 392
- Delta Pair key, 181
- dependencies, 45
- Dependencies/Couplings term, 45
- destination
 - trace 1, 146
 - trace 2, 147
 - trace 3, 147
- Destination key, 146
- Det/Demod
 - menu map, 596
- Det/Demod key, 95
- detection
 - auto on/off, 97
 - average, 98
 - negative peak, 101
 - normal, 98
 - peak, 99
 - RMS, 99
 - sample, 99
- detector
 - RMS averaging, 90
 - rules for auto selection, 97
- Detector key, 95
 - phase noise, 77
- Device BTS/MS key, 341
- device clear command, 530
- diagnostics, 279
- Diagnostics key, 274
- Dir From/To key, 152
- Dir Select key, 135, 143, 147, 151, 153, 155, 157
- Dir Up key, 135, 143, 147, 151, 153, 155, 157
- directories
 - creating, 155
 - selecting, 147
- display
 - marker readout, 186
 - frequency, 187
 - inverse time, 188
 - period, 187
 - time, 187
- menu map, 597, 598
- on/off, 125
- trace, 168
- Display front-panel key, 103, 385
- display line
 - adjusting, 103, 104, 106, 107, 108
- Display Line key, 103, 104, 106, 107, 108
- display windows
 - Marker Table, 189
- displaying
 - errors, 247
 - pages, 248
- divisions, scaling, 52
- documentation, using, 44
- DVB-T key, 340
- E**
- echo, lack of, 528
- Edge Freq key, 354
- EDGE measurement, 335
- Edit key, 114
- editing
 - amplitude, 115
 - connecting points, 116
 - deleting limits, 116
 - deleting points, 116
 - frequency, 115
 - limits, 114, 115
 - points, 114, 116
- Eject Page key, 232
- Enable All Measurements key, 344
- error handling, 557
- error messages, 542
- error monitoring, 567, 571
- errors
 - clearing, 248
 - connecting remotely, 539
 - connection refused, 541
 - connection timed out, 541
 - displaying, 247
 - file moving/copying, 540
 - LAN troubleshooting, 538
 - no response from host, 541
 - packets lost, 540
 - timeout, 539
- event status byte, enable and read, 563
- event status enable, IEEE
 - command, 563
- event status register
 - query and clear, 564
- Example term, 45
- expanding
 - display screen, 385, 479
- Ext Amp Gain key, 68
- Ext Front key, 289
- Ext Rear key, 289

external amplifier gain, 68

F

factory defaults, 261

LAN, 539

Factory key, 251

Factory Preset key, 224

Factory Preset term, 45

fail mask condition

absolute limit, 472

absolute limit AND relative limit, 472

absolute limit OR relative limit, 472

relative limit, 472

Fast Spurious Test key, 499

fast spurious testing, 499

faster measurements, display off, 125

FETCh commands, 299

FFT, 74

FFT & Sweep key, 72, 73, 74

FFTs/Span key, 75

file

all, 131

catalog, 130

copy, 151

copy now, 151

corrections, 133

delete, 147

delete now, 149

format, 139

limits, 133

load now, 144

menu map, 599, 600, 601, 602, 603, 604

name, 143, 154, 155

renaming, 153

renaming now, 153

save, 136

save now, 137

screen, 133

sort, 133, 146, 149, 152, 154

state, 131

trace, 133

type, 139, 146, 152, 154, 131

file copying/moving errors, 540

File front-panel key, 127

file source, 142

all traces, 142

trace 1, 142

trace 2, 142

trace3, 142

file type, 127, 149

Corrections, 129

Limits, 129

Measurement Results, 129

Screen, 129

State, 127

Trace, 127

files

deleting, 157

limit lines, 144

Filter Alpha key, 364, 402, 444, 476

finding

peaks, 209, 210, 211, 212, 213

flatness corrections on/off, 257

format

Bitmap, 141

CSV, 141

Metafile, 141

Reverse Bitmap, 141

Reverse Metafile, 141

Trace + State, 141

Format key, 139

format, data, 160

Free Run key, 287

Freq Interp key, 118

Freq Offset key, 167

Freq Ref key, 268

frequency channel

menu map, 605

FREQUENCY Channel

front-panel key, 163

frequency condition register, 576, 577, 578

frequency corrections on/off, 257

frequency count, 194

Frequency key, 64, 66, 67, 115, 187

frequency offset, ACP, 354

frequency parameter (variables), 507

frequency reference, 268

Front Panel Test key, 274

front-panel features (see Getting Started guide), 44

front-panel key

AMPLITUDE Y Scale, 49

AUTO COUPLE, 71

Display, 103, 385

File, 127

FREQUENCY Channel, 163

Input/Output, 171, 425, 426

Marker, 177, 391, 483

Marker -->, 197

Marker Fctn, 191

Meas Setup, 201, 351, 371, 381, 399, 409, 423, 429, 451, 457, 485

Measure Control, 329

MODE, 203

Mode Setup, 333

Peak Search, 209

Preset, 221

Print, 227

Print Setup, 229

Restart, 347

Save, 235

Single, 349

SPAN X Scale, 237, 389, 481

SWEEP, 241

System, 247

Trace/View, 283, 367, 377, 405, 421, 447, 477, 479

TRIG, 287

front-panel keys

Det/Demod, 95

Input/Output, 309, 312, 318, 321, 322

MEASURE, 297

Full Screen key, 103, 385, 479

Full Span key, 238

Function Off key, 194

G

G/PAL/NICAM, 340

Gate Time key, 196

Gated FFT

measurement, 74

gaussian trace, 386

Gaussian Trace key, 386

GPIB Address key, 263

GPIB bus information, 554

GPIB command statements, 554

GSM/EDGE key, 335

H

handset setup, 341

hardware status, 557, 571

Harmonic Dist key, 315

Harmonic Distortion

Meas Setup menu, 640

Trace/View menu, 641

harmonic distortion

key, 315

measurement, 315

harmonic distortion measurement

measurement setup, 409

harmonics key, 410

Hiper LAN/2 key, 339

Host ID, 264

Host Name key, 264

HP BASIC, 531

HP VEE, over socket LAN, 536

HP VISA libraries, 532

HP-IB address, 263

I

I/PAL/NICAM, 340
identity, IEEE command
 options, query
 model number, query, 564
IEEE command, 564
IEEE command termination, 509
IEEE command, event status
 enable, 563
IEEE common commands
 *commands, IEEE, 563
impedance setting, 172
initiate measurement, 330, 568
Input Port key, 171
Input Z Corr key, 172
input/output
 menu map, 606
Input/Output front-panel key,
 171, 309, 312, 318, 321, 322,
 425, 426
instrument preset, 566
instrument status, 557, 571
 monitoring, 567
 monitoring status monitoring,
 567
Int Preamp key, 59
integer variable (variables), 507
integration bandwidth, 400
Integration BW key, 400
integrity condition register, 578,
 579
integrity signal condition register,
 580, 581
Inverse Time key, 188
IP Address key, 263, 265
IS95 key, 334

J

Java
 program, 538
 programing socket LAN, 538
J-STD-008 key, 334

K

key press counter, 274
keyboard lock, 280
keys
 control, 47, 175, 207
keyword parameter (commands),
 506

L

L/SECAM/NICAM, 340
LabView, using it over LAN, 536
LAN
 bus, 524

C program, 538
cable, 544
Java program, 538
SICL, 267, 531
socket programming, 530
sockets, 266
telnet, 266, 527
types of access, 265
 using, 524
 VEE program, 536
LAN defaults, 539
LAN troubleshooting, 538
Landscape key, 231
Language key, 230
Last Span key, 239, 481
License Key
 key, 277
Licensing key, 276, 279
limit
 off, 110
 on, 110
 test off, 111
 test on, 111
Limit 1 key, 109
Limit 2 key, 109
Limit key, 110
Limit Test key, 363, 443
limit type, 110
Limits
 file type, 129
limits
 amplitude
 editing
 limits, 115
 connecting points
 editing
 limits, 116
 deleting, 122
 deleting limits
 editing
 limits, 116
 deleting points
 editing
 limits, 116
 editing, 114
 fail mask condition, 472, 474,
 475
 fixed, 121
 interpolation, 118, 119
 Lin, 118, 119
 Log, 118, 119
 lower, 109
 margin, 112
 point, 114
 relative, 121
 segments, 120

 test, 111
 time, 115
 units, 120
 upper, 109
Limits key, 108, 121, 133
Line key, 288
Linear
 scale type, 52
listener, 554
Load key, 143
Load Now key, 144
loading
 files, 144
 limit lines from file, 144
local echo, lack of, 528
locating
 peaks, 209, 210, 211, 212, 213
Log
 scale type, 52
log-power averaging, 89
Log-Pwr Avg key, 90
lower
 limit type, 110
lower limit, 109
Lower Offset Limit key, 440

M

manual, using, 44
margin
 off, 112
 on, 112
Margin key, 112
marker
 menu map, 607
 moving to center frequency, 212
 X position, 395, 396, 397
Marker --> front-panel key, 197
Marker ->CF key, 197
Marker ->CF Step key, 197
Marker ->Ref Lvl key, 200
Marker ->Start key, 197
Marker ->Stop key, 199
Marker All Off key, 189, 394
marker control mode
 Delta, 181, 392
 Delta Pair, 181
 Normal, 180, 392, 484
 Span Pair, 184
Marker Count key, 194
 access, 194
Marker Δ ->Span key, 199
marker fetn
 menu map, 609
Marker Fctn front-panel key, 191
Marker front-panel key, 177, 391,
 483
marker function, 191

- Marker Noise key, 191
 - Marker Table key, 189
 - marker to
 - menu map, 608
 - Marker Trace key, 185, 394
 - markers
 - all off, 189, 394
 - bandwidth power, 193
 - frequency readout, 187
 - inverse time readout, 188
 - moving, 197, 199, 200, 209
 - off, 185, 189, 194, 394, 484
 - peak
 - continuous, 212, 213
 - excursion, 215
 - minimum search, 211
 - next, 209
 - next left, 210
 - next right, 210
 - search, 218
 - threshold, 216
 - peak to peak search, 212
 - period readout, 187
 - readout, 186
 - search
 - parameters, 215
 - selecting, 180, 185, 392, 394, 483
 - time readout, 187
 - to center frequency, 197
 - to center frequency step, 197
 - to reference level, 200
 - to span, 199
 - to start frequency, 197
 - to stop frequency, 199
 - trace assignment, 186, 394
 - markers off, 180, 392, 483
 - Max Hold key, 285, 369, 379, 406, 450, 452
 - Max Mixer Lvl key, 69
 - Maximum Value term, 45
 - Meas BW key, 381
 - Meas Control
 - menu, 626
 - Meas Interval key, 382
 - Meas Off key, 300
 - Meas Setup
 - ACP Measurement, 351, 371
 - CCDF Measurement, 381
 - Channel Power Measurement, 399
 - Harmonic Distortion Measurement, 409
 - Occupied BW Measurement, 423, 451, 457, 485
 - Meas Setup front-panel key, 201, 351, 371, 381, 399, 409, 423, 429, 451, 457, 485
 - Meas Type key, 359, 458, 497
 - MEASURE
 - menu, 625
 - MEASure commands, 298
 - Measure Control front-panel key, 329
 - MEASURE front-panel key, 297
 - Measure key, 329
 - measure setup
 - frequency span, 425
 - spectrum segment offset
 - offsets and limits, 462
 - measurement
 - gated FFT, 74
 - resume, 329
 - measurement bandwidth, 381
 - measurement modes
 - selecting, 203, 204, 206
 - measurement reference type
 - power spectral density reference, 458
 - total power reference, 458
 - Measurement Results
 - file type, 129
 - measurement time interval, 382
 - measurements
 - aborting, 331
 - adjacent channel power, 305
 - bottom/middle/top, 514
 - burst power, 377
 - channel power, 301
 - harmonic distortion, 315
 - increasing speed, 511
 - multi-carrier power, 429
 - occupied bandwidth, 304
 - pausing, 330
 - query current, 328
 - resuming, 330
 - setting default values remotely, 298
 - turning off, 300
 - menu map
 - ACP
 - Meas Setup key, 629
 - Trace/View key, 630
 - alpha editor, 588, 589
 - amplitude Y scale, 590, 591
 - auto couple, 592, 593, 594
 - Burst Power
 - Meas Setup key, 631
 - Trace/View key, 632
 - BW/Avg, 595
 - CCDF (Power Stat)
 - Display key, 635
 - Marker key, 637
 - Meas Setup key, 633
 - SPAN X Scale key, 636
 - Trace/View key, 634
 - Channel Power
 - Meas Setup key, 638
 - Trace/View key, 639
 - Det/Demod, 596
 - display, 597, 598
 - file, 599, 600, 601, 602, 603, 604
 - frequency channel, 605
 - Harmonic Distortion
 - Meas Setup key, 640
 - Trace/View key, 641
 - input/output, 606
 - marker, 607
 - marker fctn, 609
 - marker to, 608
 - Meas Control, 626
 - MEASURE, 625
 - mode, 610
 - Mode Setup, 627, 628
 - Multi-Carrier Power
 - Meas Setup key, 648
 - Trace/View key, 644
 - Occupied Bandwidth
 - Meas Setup key, 645
 - peak search, 611
 - preset, 612
 - span X scale, 614
 - CCDF, 615
 - Spectrum Emission Mask
 - Display key, 648
 - Marker key, 650
 - Meas Setup key, 646
 - SPAN X Scale key, 649
 - Trace/View key, 647
 - Spurious Emissions
 - Meas Setup key, 651
 - sweep, 616
 - system, 617
 - Third Order Intercept
 - Meas Setup key, 642
 - trace/view, 621
 - trig, 622
- message
 - to other users, 280, 281
- Metafile
 - format, 141
 - screen file, 129
- Metafile key, 141
- Method key, 360, 441
- Min Hold key, 285, 369, 379, 406, 450

- power on
 - preset, 248
 - Power On key, 249
 - Power On/Preset key, 248
 - power parameter (variables), 507
 - power spectral density, 362
 - power stat CCDF
 - Gaussian line display, 386
 - power statistics CCDF
 - measurement interval, 382
 - number of sampling points, 382
 - reference trace display, 386
 - store reference trace, 385
 - power-on
 - time, 281
 - power-on status clear, IEEE
 - command, 566
 - preamp, internal, 59
 - Preferences key, 386, 479
 - Presel Adjust key, 55
 - Presel Center key, 54
 - preselector
 - adjusting, 55
 - preselector center, 54
 - Preset
 - factory, 224
 - mode, 224
 - power on, 248
 - user, 222
 - preset, 566
 - factory, 251
 - menu map, 612
 - mode, 251
 - saving, 225, 252
 - status registers, 573
 - user, 250
 - preset defaults
 - LAN, 539
 - Preset front-panel key, 221
 - Preset Type key, 250
 - Previous Page key, 248
 - print
 - aborting, 227
 - Print front-panel key, 227
 - Print Setup front-panel key, 229
 - printer
 - color, 234
 - color capability, 230
 - compatibility, 229
 - eject page, 232
 - language
 - PCL3, 229
 - PCL5, 229
 - language, PL3/PL5, 230
 - orientation, 231
 - landscape, 231
 - portrait, 231
 - paper size, 232
 - printer language, 229
 - prints per page, 232
 - printer setup, 229
 - Printer Setup key, 229
 - printer, parallel
 - HP printers, 229
 - printout orientation, 231
 - Prints/Page key, 232
 - programmer's reference, using, 44
 - programming
 - command parameters, 506
 - command syntax, 503
 - compatibility among PSA
 - modes, 519, 521
 - compatibility, PSA series versus VSA, 522
 - example using C language, 549
 - SCPI basics, 503
 - socket LAN, 530, 538
 - using C language, 546
 - valid commands, 504
 - via LAN, 530
 - with C, 538
 - with Java, 538
 - programming commands, IEEE, 563
 - PSA series versus VSA
 - (programming compatibility), 522
 - PSD Ref key, 458, 461
 - Pwr Avg key, 91
- ## Q
- questionable condition register, 573, 574
- ## R
- Radio Std Setup key, 341
 - Range key, 412, 414, 488
 - range table, 412, 413, 414, 486, 488
 - Range Table key, 413, 486
 - ratio
 - VBW/RBW, 86
 - READ commands, 299, 300
 - Readout key, 186
 - real number data format, 160
 - rear-panel features (see Getting Started guide), 44
 - recall, IEEE command, 566
 - Ref BW key, 357
 - Ref Carrier Freq key, 433
 - Ref Carrier key, 431
 - Ref Channel key, 458
 - Ref Level key, 49, 498
 - Ref Lvl Offset key, 58
 - Ref Trace key, 386
 - reference bandwidth, 357
 - reference level, 498
 - reference level key, 49
 - reference level offset, 58
 - reference trace, 386
 - reference trace, storing, 385
 - register
 - calibration condition, 575, 576
 - frequency condition, 576, 577, 578
 - integrity condition, 578, 579
 - integrity signal condition, 580, 581
 - operation condition, 571, 572
 - power condition, 583, 584, 585
 - questionable condition, 573, 574
 - temperature condition, 585, 586
 - registers
 - calibration condition, 575, 576
 - relative power parameter
 - (variables), 507
 - Remote Command term, 45
 - Rename key, 153
 - Rename Now key, 153
 - renaming
 - files, 153
 - Res BW key, 83, 416, 460, 490
 - reset, IEEE command, 566
 - resolution bandwidth, 83, 416, 490
 - adjusting, 83
 - Resolution BW Auto Man, 83
 - Restart front-panel key, 347
 - restart the measurement, 329
 - Restor Sys Defaults key, 274
 - Restore Align Defaults key, 261
 - restoring
 - defaults, 261
 - system defaults, 274
 - results data, identifying block size, 508
 - Resume key, 330
 - resume the measurement, 329
 - Retain Params key, 342
 - Reverse Bitmap
 - format, 141
 - Reverse Bitmap key, 141
 - Reverse Metafile
 - format, 141
 - Reverse Metafile key, 141
 - RF Burst key, 289
 - RF Coupling key, 172
 - RF Envelope key, 377
 - RF key, 171
 - RMS detection (averaging), 91

- RMS detection command
 - (averaging), 90, 99
- RRC filter, 476
- RRC Filter key, 363, 402, 444, 475
- RST term, 45
- S**
- Sample key, 99
- save
 - file, 136
- Save front-panel key, 235
- Save key, 136
- Save Now key, 137
- Save User Preset key, 225, 252
- save, IEEE command, 567
- saved
 - state, 45
- saving
 - trace data, 158, 421, 477, 478
 - user preset, 225, 252
- scale per division, 52
- scale type
 - Linear, 52
 - Log, 52
- Scale Type key, 52
- Scale/Div key, 52
- SCPI
 - version of, 281
- SCPI LAN
 - control, 267
 - socket, 266
 - telnet, 266
- SCPI LAN key, 265
- SCPI language
 - basic info, 503
 - command parameters, 506
 - command syntax, 503
 - keyword parameters, 506
 - valid commands, 504
- screen divisions, scaling, 52
- Screen file type, 129
- Screen files
 - Bitmap, 129
 - Metafile, 129
- Screen key, 133
- Search Param key, 215
- searching
 - parameters, 215
 - peak excursion, 215
 - peak threshold, 216
 - peaks, 209, 210, 211, 212, 213
- Select Marker key, 180, 392, 483
- selecting
 - ac coupling, 172
 - amplitude reference, 171
 - color palette, 274
 - dc coupling, 172
 - directories, 135, 143, 147, 151, 153, 155, 157
 - display color schemes, 272
 - frequency reference
 - external, 268
 - internal, 268
 - instrument modes, 204
 - marker pairs, 180, 392, 483
 - markers, 180, 392, 483
 - Marker Trace, 185, 394
 - modes, 204
 - single or continuous sweep, 242
 - source, 152
 - sweep time, 241
 - sweep type
 - FFTs/Span, 75
- selecting printer paper size, 232
- self-test, 568
- SEM measurement
 - trace, 421, 477
 - viewing trace, 421, 477
- serial number, query, 564
- Service key, 279
- service request, IEEE command, 567
- service requests, 557
- Set Date key, 254
- Set Time key, 253
- setting
 - center frequency, 163
 - center frequency step, 166
 - date, 254
 - frequency offset, 167
 - numeric data file format, 160
 - parameters
 - peak search, 218
 - start frequency, 164
 - stop frequency, 165
 - the input port, 171
 - time, 253
 - time and date, 252
- trigger
 - external trigger input, 173, 289
 - free run, 287
 - line, 288
 - offset, 291
 - polarity, 290
 - RF Burst, 289
 - time delay, 290
 - video, 288
- setting impedance, 172
- show errors, 247
- Show Errors key, 247
- Show Hdwr key, 271
- Show License key, 278
- Show System key, 270
- showing
 - hardware, 271
 - license, 278
 - system, 270
- SICL LAN, 531
- SICL over LAN, 267
- Signal BW key, 341
- Signal Track key, 168
- Single front-panel key, 349
- single measurement, 329
- socket LAN
 - programming, 536
 - with C program, 538
 - with Java program, 538
- socket programming, 530
- sockets over LAN, 266
- sort
 - by date, 133
 - by extension, 135
 - by name, 133
 - by size, 135
 - order up down, 135
- Sort key, 133, 146, 149, 152, 154
- source
 - selecting, 152
- Source key, 142
- span, 415
- Span key, 237, 238, 415, 481
- Span Pair key, 184
- span X scale
 - CCDF
 - menu map, 615
 - menu map, 614
- SPAN X Scale front-panel key, 237, 389, 481
- spectral density, 362
- Spectrum Analysis key, 204
- Spectrum Emission Mask
 - Display menu, 648
 - Marker menu, 650
 - Meas Setup menu, 646
 - SPAN X Scale menu, 649
 - Trace/View menu, 647
- spectrum emission mask
 - measure setup
 - measurement reference type, 458
- Spur key, 498
- Spurious Emissions
 - Meas Setup menu, 651
- spurious test
 - fast, 499
- SRQ, 557, 567
- ST/Harmonic key, 410
- standard event status byte, enable and read, 563

- standard event status register, IEEE command, 564
 - standards setup, 341
 - Start Freq key, 164, 488
 - start frequency, 488
 - start measurement, 330, 568
 - State
 - file type, 127
 - state
 - get data, 564
 - recalling, 566
 - saved, 45
 - saving, 567
 - State key, 131
 - State Saved term, 45
 - states
 - automatic detection, 97
 - status
 - preset, 573
 - status byte
 - clearing, 563
 - register system, 557
 - status byte, IEEE command, 567
 - status subsystem, 571
 - Stop Freq key, 165, 490
 - stop frequency, 490
 - Store Ref Trace key, 385
 - string parameter (variables), 507
 - Subnet Mask key, 265
 - sweep
 - menu map, 616
 - Sweep Cont/Single key, 242
 - SWEEP front-panel key, 241
 - sweep points, 244
 - sweep states, switching, 243
 - sweep time, 418, 419, 491
 - Sweep Time key, 241, 418, 419, 459, 491
 - sweep time, automatic, 243
 - synchronization, 565, 568
 - system
 - menu map, 617
 - System front-panel key, 247
 - system message, 280, 281
- ## T
- table
 - range, 413, 486
 - setting
 - range, 412, 414, 488
 - talker, 554
 - telnet over LAN, 266
 - telnet, using, 527
 - temperature condition register, 585, 586
 - terms
 - *RST, 45
 - book, 45
 - definition, 45
 - dependencies/couplings, 45
 - example, 45
 - factory preset, 45
 - maximum value, 45
 - maximum value, 45
 - remote command, 45
 - state saved, 45
- test
 - limits, 111
 - margin, 112
 - Test key, 111
 - test, IEEE command, 568
 - testing
 - spurs, 499
 - TETRA key, 338
 - Third Order Intercept
 - Meas Setup menu, 642
 - throughput, improving, 511
 - time
 - display on/off, 253
 - displaying, 252
 - setting, 252, 254
 - time corrections, 262
 - Time key, 187
 - limits
 - frequency, 115
 - time parameter (variables), 507
 - time selective spectrum analysis, 80
 - time since power-on, 281
 - Time/Date key, 252, 253
 - timeout errors, 539
 - timing control, 565, 568
 - Title key, 122
 - Total Pwr Ref key, 362, 442, 461
 - Total Pwr Refl key, 458
 - Trace
 - file type, 127
 - trace
 - destination, 146
 - points, 158
 - saving, 158, 421, 477, 478
 - transfer data, 158, 421, 477, 478
 - Trace + State
 - format, 141
 - key, 141
 - Trace + State trace type, 127
 - Trace 1 key, 142, 146
 - Trace 2 key, 142, 147
 - Trace 3 key, 142, 147
 - trace averaging, 451, 452, 582, 583
 - trace data
 - moving, 421, 477, 478
 - trace data format, 508
 - trace display, 168
 - trace format, 160
 - Trace key, 133, 284, 368, 369, 378, 405, 406, 448
 - trace points, 284
 - trace type
 - CSV, 129
 - Trace + State, 127
 - trace/view
 - menu map, 621
 - Trace/View front-panel key, 283, 367, 377, 405, 421, 447, 477, 479
 - transmit frequency error
 - Occupied BW, 455
 - trig
 - menu map, 622
 - Trig Delay key, 290
 - TRIG front-panel key, 287
 - Trig Input key, 173
 - Trig Offset command, 291
 - Trig Slope key, 290
 - trigger measurement, 330
 - trigger, IEEE command, 568
 - turning markers off, 185, 394, 484
 - type
 - lower limit, 110
 - upper limit, 110
 - Type key, 110, 131, 139, 146, 149, 152, 154
- ## U
- units parameter (commands), 506
 - upper, 110
 - upper limit, 109
 - Upper Offset Limit key, 439
 - URL (Agilent Technologies), 2
 - US PCS
 - band class, 342
 - US/K
 - band class, 342
 - user
 - correction, 61
 - User key, 250
 - User Preset key, 222
 - user's reference, using, 44
- ## V
- variable parameter (commands), 506
 - variables
 - angle parameter, 507
 - bit_data parameter, 507
 - degree parameter, 507
 - frequency parameter, 507

integer parameter, [507](#)
parameters, [507](#)
percent parameter, [507](#)
phaseparameter, [507](#)
power parameter, [507](#)
relative power parameter, [507](#)
string parameter, [507](#)
time parameter, [507](#)
voltage parameter, [507](#)
VBW/RBW key, [86](#)
VBW/RBW ratio, [86](#)
VEE over socket LAN, [536](#)
VEE, using it over LAN, [536](#)
video averaging, [89](#)
video bandwidth, [418](#), [491](#)
video bandwidth, adjusting, [84](#)
Video BW, [84](#)
Video BW key, [84](#), [418](#), [491](#)
Video key, [288](#)
View key, [286](#), [369](#), [379](#), [406](#), [450](#)
VISA libraries, [532](#)
VISA library, [547](#), [549](#)
Vision Impair 1 key, [272](#)
Vision Impair 2 key, [272](#)
voltage averaging, [89](#)
Voltage Avg key, [91](#)
voltage parameter (variables),
[507](#)
Volts key, [57](#)
VSA versus PSA series
(programming compatibility),
[522](#)
VTL, compiling and linking C
language, [547](#)

W

wait, IEEE command, [568](#)
Watts key, [58](#)
windows
Marker Table, [189](#)

X

X Axis Units key, [120](#)
x dB key, [455](#)

Y

Y Axis Units
dBm, [57](#)
dBmV, [57](#)
dBuV, [57](#)
volts, [57](#)
watts, [58](#)
Y Axis Units key, [56](#)

Z

Zero Span key, [238](#)

